

HF TRANSCEIVER

TS-50S

INSTRUCTION MANUAL

KENWOOD CORPORATION

KENWOOD

IMPORTANT SAFETY INSTRUCTIONS

Thank you for purchasing this new transceiver.

Notice to the user:

One or more of the following statements may be applicable to this equipment.

FCC WARNING

This equipment generates or uses radio frequency energy. Changes or modifications to this equipment may cause harmful interference unless the modifications are expressly approved in the instruction manual. The user could lose the authority to operate this equipment if an unauthorized change or modification is made.

Information to the digital device user required by the FCC:

This equipment has been tested and found to comply with the limits for a Class B digital device, pursuant to Part 15 of the FCC Rules. These limits are designed to provide reasonable protection against harmful interference in a residential installation. This equipment generates, uses and can generate radio frequency energy and, if not installed and used in accordance with the instructions, may cause harmful interference to radio communications. However, there is no guarantee that the interference will not occur in a particular installation. If this equipment does cause harmful interference to radio or television reception, which can be determined by turning the equipment off and on, the user is encouraged to try to correct the interference by one or more of the following measures:

- Reorient or relocate the receiving antenna.
- Increase the separation between the equipment and receiver.
- Connect the equipment into an outlet on a circuit different from that to which the receiver is connected.
- Consult the dealer for technical assistance.

SAFETY PRECAUTIONS

Please read all safety and operating instructions before using this unit. For best results, be aware of all warnings on the unit and follow the provided operating instructions. Retain these safety and operating instructions for future reference.

1 Power Sources

Connect this unit only to the power source described in the operating instructions or as marked on the unit itself.

2 Power Cable Protection

Route all power cables safely. Ensure the power cables can neither be walked upon nor pinched by items placed near or against the cables. Pay particular attention to locations near AC receptacles, AC extension bars and points of entry to the unit.

Never pull or stretch the cord.



3 Abnormal Odors

The presence of an unusual odor or smoke is often a sign of trouble. Immediately turn the power OFF and remove the power cable. Contact a dealer or the nearest service center for advice.

POWER OFF!

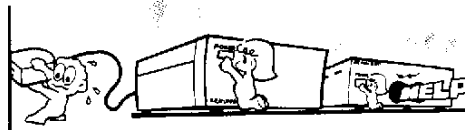

4 Electrical Shocks

Take care not to drop objects or spill liquids into the unit through enclosure openings. Metal objects, such as hairpins or needles, inserted into the unit may contact voltages resulting in serious electrical shocks. Never permit children to insert any objects into this unit.

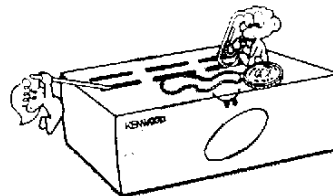

5 Grounding and Polarization

Do not attempt to defeat methods used for grounding and electrical polarization in the unit, particularly involving the input power cable.

IMPORTANT SAFETY INSTRUCTIONS

6 Ventilation

Locate the unit so as not to interfere with its ventilation. Do not place books or other equipment on the unit that may impede the free movement of air. Allow a minimum of 4 inches (10 cm) between the rear of the unit and the wall or operating desk shelf.

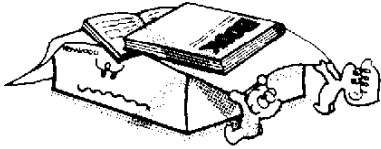

7 Water and Moisture

Do not use the unit near water or sources of moisture. For example, avoid use near bathtubs, sinks, swimming pools, and in damp basements and attics.

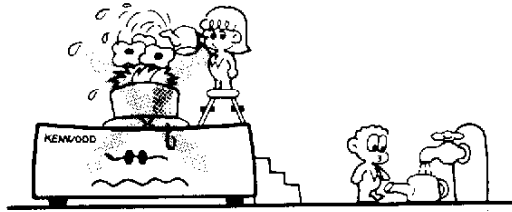

8 Outdoor Antenna Grounding

Adequately ground all outdoor antennas used with this unit using approved methods. Grounding helps protect against voltage surges caused by lightning. It also reduces the chance of a build-up of static charges. Section 810 of the National Electrical Code, ANSI/NFPA 70, provides information with respect to proper grounding of the mast and supporting structure, grounding of the lead-in wire to an antenna discharge unit, size of grounding conductors, location of antenna-discharge unit, connection to grounding electrodes, and requirements for the grounding electrode. See the accompanying illustration.

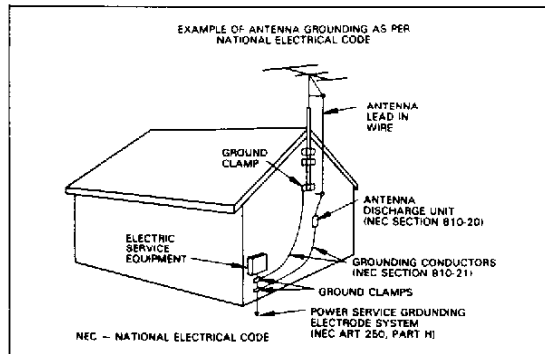

9 Power Lines

Minimum recommended distance for an outdoor antenna from power lines is one and one-half times the vertical height of the associated antenna support structure. This distance allows adequate clearance from the power lines if the support structure should fall for any reason.

10 Heat

Locate the unit away from heat sources such as radiators, stoves, amplifiers or other devices that produce substantial amounts of heat.

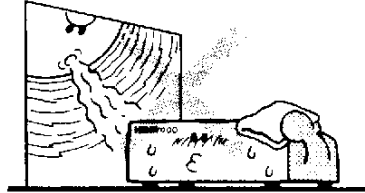

11 Cleaning

Do not use volatile solvents such as alcohol, paint thinner, gasoline or benzene to clean the cabinet. Use a clean dry cloth.

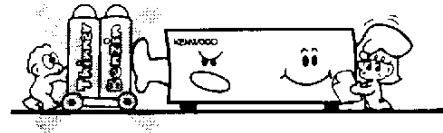

12 Periods of Inactivity

Disconnect the input power cable from the power source when the unit is not used for long periods of time.

13 Servicing

Remove the unit's enclosure only to do accessory installations described by this manual or accessory manuals. Follow provided instructions carefully to avoid electrical shocks. If unfamiliar with this type of work, seek assistance from an experienced individual, or have a professional technician do the task.

14 Damage Requiring Service

Enlist the services of qualified personnel in the following cases:

- The power supply cable or plug is damaged.
- Objects have fallen, or liquid has spilled into the unit.
- The unit has been exposed to rain.
- The unit is operating abnormally or performance has degraded seriously.
- The unit has been dropped, or the enclosure damaged.

GENERAL DESCRIPTION

Thank you for purchasing this new **KENWOOD compact HF transceiver**. This transceiver has many powerful features. To get the most out of these features, we suggest you read this instruction manual carefully, and keep it handy for further reference. This transceiver provides these main features:

- 1 This radio is **so compact** that you can easily transport, install and operate from either a portable, mobile or fixed station installation.
- 2 **Setting-up transceiver** functions is simple with the easy-to-use Menu System. The transceiver delivers dozens of functions required by hams.
- 3 The **Busy-Frequency Stop** automatically stops scan on a busy frequency. Time Operated and Carrier Operated modes are provided for this function.
- 4 The **tuning control** automatically changes the frequency step, depending on how fast the control is rotated. (Achieved by a "fuzzy logic" control technique).
- 5 The **TF-SET** function allows changing the transmit frequency while still listening to your received signal.
- 6 The **Automatic Power Off function** switches off the power if the transceiver has not been operated for approximately three hours.
- 7 The **MC-47 microphone** allows assigning four control functions to the microphone PF (Programmed Function) keys.

In addition, this transceiver offers many other HF transceiver functions, even though it is very compact.

Information:

- 1 Noise entering from the DC power supply, or static electricity may disable the buttons or the tuning control. If this occurs, determine the source of the interference and take appropriate measures to reduce or eliminate the offending noise. If the transceiver still does not function normally, reset the microprocessor. (For the reset procedure, refer to page 45.)
- 2 Resetting the transceiver will clear the memory channels and return the menu settings (described later) to their default values.
- 3 This transceiver contains a cooling fan. As the heat sink temperature rises because of continuous transmission, the fan speed accelerates to its maximum speed, and the sound of the fan will become more noticeable. If the heat sink temperature becomes excessively high, the temperature protection circuit will trip to reduce the transmission output.

For extended transmit periods, or when operating FM or RTTY, we recommend selecting 50 W or 10 W transmitter output power.

TABLE OF CONTENTS

CHAPTER 1 INSTALLATION AND CONNECTION

PREPARATION FOR MOBILE OPERATION	7
Mobile Installation	7
DC Power Cable Connection	7
Antenna Connection	7
Ground Connection	8
Ignition Noise	8
PREPARATION FOR FIXED STATION OPERATION ..	9
DC Power Supply Connection	9
Antenna Connection	9
Ground Connection	10
ACCESSORY CONNECTIONS	11

CHAPTER 2 CONTROLS AND CONNECTORS

FRONT PANEL CONTROLS	12
REAR PANEL CONNECTORS	18
DISPLAY	19

CHAPTER 3 COMMUNICATION

CONFIRMATION BEFORE OPERATION	21
SSB OPERATION	22
Reception	22
Transmission	22
CW OPERATION	23
Reception	23
Transmission	24
FM OPERATION	25
Reception	25
Transmission	25
AM OPERATION	26
Reception	26
Transmission	26
DATA OPERATION (PACKET, AMTOR, RTTY)	27
Reception	27
Transmission	28
FM REPEATER OPERATION	29
SPLIT-FREQUENCY OPERATION	30

CHAPTER 4 MEMORY FEATURES

MICROPROCESSOR MEMORY BACKUP	31
MEMORY CHANNEL DATA	31
MEMORY CHANNEL STORAGE	31
Simplex-frequency Channel Storage	31
Split-frequency Channel Storage	32
Scan Start and End Frequency Storage	32
MEMORY CHANNEL RECALL	33
MEMORY CONTENTS CONFIRMATION	33
MEMORY TRANSFER	33
MEMORY CHANNEL CLEAR	34
MEMORY CHANNEL PROTECT	35
Memory Protect 1	35
Memory Protect 2	35
QUICK MEMORY CHANNEL SELECT	36
Selecting a Channel Containing Data	36
Selecting an Empty Channel	36

CHAPTER 5 SCAN

MEMORY SCAN	37
Group Scan	37
All-channel Scan	37
Confirming Start and End Frequencies	38
Memory Channel Lock-Out	38
PROGRAM SCAN	39
Scan	39
Confirming Start and End Frequencies	39
Scan Hold	39
BUSY-FREQUENCY STOP	40
SCAN SPEED CHANGE	40

CHAPTER 6 OTHER USEFUL FEATURES

CONTROLS	41
Frequency Step Change	41
Amateur Band Switching	41
RIT Operation	41
DUAL DIGITAL VFOs	42
AUTOMATIC POWER OFF (APO)	42
INTERFERENCE AND NOISE ELIMINATION	43
IF Shift	43
IF Filter	43
Noise Blanker	43
AUDIO AND SOUND FEATURES	43
Beep Tone	43
Mode Confirmation Tone Output	43
Morse Code Alarm Output	44
Carrier Point Shift	44
MICROPROCESSOR RESET	45
Initial Settings	45
Reset	45

CHAPTER 7 MENU SET-UP

MENU A SETTING	46
MENU B SETTING	47

CHAPTER 8 OPERATION USING ACCESSORIES

LINEAR AMPLIFIER	48
Connection to the Transceiver	48
AUTOMATIC ANTENNA TUNER	48
Connection to the Transceiver	48
Operation	48
MICROPHONE	49
UP and DWN Buttons	49
PTT Button	49
Programmable Function Keys	49

CHAPTER 9 MAINTENANCE AND ADJUSTMENTS

GENERAL INFORMATION	51
SERVICE	51
CLEANING	51

TROUBLESHOOTING	52
Reception	52
Transmission	53
ADJUSTMENTS	54
REFERENCE FREQUENCY CALIBRATION	54

CHAPTER 10 OPTIONS INSTALLATION

FILTER	55
TCXO UNIT (SO-2)	56

OPTIONAL ACCESSORIES

SPECIFICATIONS

ACCESSORIES

MC-47 Multifunction Microphone (T91-0528-05)	1 ea.
DC Power Cable (E30-3157-05)	1 ea.
Handle (K01-0416-05)	1 ea.
Calibration Cable (E31-2154-05)	1 ea.
To set the reference frequency	
Fuse, 25A (F05-2531-05)	1 ea.
For the DC power cable	
Fuse, 4A (F06-4029-05)	1 ea.
For internal circuitry	
Mounting Bracket (J29-0422-13)	1 ea.
Screws (N99-0321-05)	1 set
Warranty Card	1 copy
U.S.A./Canada and Europe versions only	
Instruction Manual (B62-0291-00)	1 copy

Save the box and packing in the event the transceiver is to be transported for portable or remote operation, or shipped for upgrade, maintenance or service.

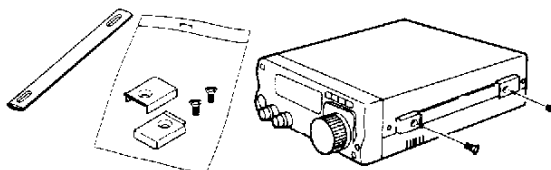

1 INSTALLATION AND CONNECTION

PREPARATION FOR MOBILE OPERATION

When you use this transceiver for mobile operation, do not attempt to perform any kind of configuration or menu set-up operation while driving your car, simply because it is too dangerous. Stop the car and then perform transceiver configuration. In addition, do not wear headphones when you are driving.

MOBILE INSTALLATION

You should install the transceiver in a safe and convenient position inside your vehicle so as not to subject yourself to danger while driving.

For example, install the transceiver under the dash in front of the passenger seat so that knees or legs will not strike the radio if you brake suddenly.

● Installation example

- 1 Install the mounting bracket using the supplied flat washers and self-tapping screws.
- 2 Position the transceiver in the bracket to determine the best viewing angle.
- 3 Insert and tighten the supplied SEMS screws and washers.

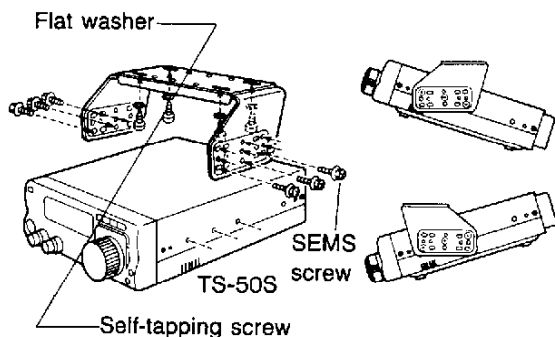

You can also use the optional MB-13 mounting bracket. For the correct mounting procedure, refer to the instructions packaged with the MB-13.

DC POWER CABLE CONNECTION

Connect the DC power cable directly to the vehicle's battery terminals using the shortest route. Do not use the cigarette lighter socket since vibration may loosen the connection, resulting in poor transceiver performance due to an unstable power source.

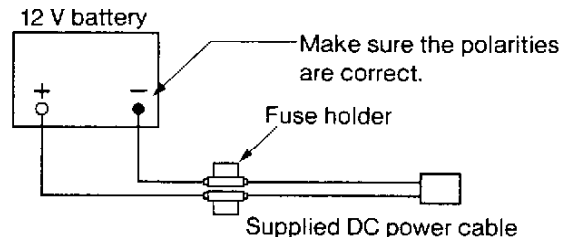

Be sure to use a 12 V vehicle battery which has sufficient current capacity.

If the current to the transceiver is insufficient, the display may darken during transmission (at audio peaks during SSB operation), or transmitter output power may drop excessively.

Note: If you use the transceiver for a long period when the vehicle battery has not been fully charged, or when the engine has been stopped, the battery may become discharged, and will not have sufficient reserves to start the vehicle. Avoid using the transceiver under these conditions.

ANTENNA CONNECTION

Use a whip antenna for mobile operation. HF mobile antennas are larger (and have a larger wind load) and are heavier than VHF antennas. Therefore, use a strong and rigid mount to safely and securely install the HF mobile antenna.

The success of your mobile installation will depend largely on the type of antenna, and its correct installation. The transceiver can give excellent results, if the antenna system and its installation is given careful attention.

The performance requirements of a mobile antenna are the same as those for a fixed station installation. (Refer to page 9.)

1 INSTALLATION AND CONNECTION

GROUND CONNECTION

The ground, which is the other half of the antenna system, is very important when using a mobile whip antenna. Connect the feed line ground for the antenna securely to the vehicle's chassis, and be certain to bond (electrically connect) the vehicle body to the chassis. The sheet metal will provide the primary ground plane, so be sure to establish a good RF connection from the feed line to both the chassis and the body. For comprehensive information on mobile antennas and their successful installation and optimization, refer to the ARRL Handbook or similar publications.

If your car has plastic bumpers, make sure to ground the antenna mount to the body and the chassis of the car.

IGNITION NOISE

This transceiver has been designed with a Noise Blanker to filter ignition noise. However, some cars may generate excessive ignition noise. If there is excessive noise, use suppressor spark plugs (with resistors), or perform other countermeasures as may be required to reduce these undesired electrically generated noises. The ARRL Handbook, or other similar reference, has a wealth of information regarding this topic.

Note:

- 1 The negative lead from the battery must remain disconnected until all connections are completed, in order to prevent the possibility of an accidental short circuit during installation.*
- 2 After installation and wiring, confirm that all work has been performed correctly, then reconnect the negative battery lead.*
- 3 If the fuse blows, check that the power cable has not been damaged or short circuited, is not pinched or squashed, etc. After resolving the problem, replace the fuse with one of the same type and rating.*
- 4 After the wiring is finished, wrap the fuse holder with heat-resistant tape to protect the fuse against heat and moisture.*
- 5 DO NOT remove the fuse holder even if the power cable is too long.*

1 INSTALLATION AND CONNECTION

PREPARATION FOR FIXED STATION OPERATION

The following figure illustrates how the cables must be connected on the rear of the transceiver. Connect the cables securely so they will not come loose if they are pulled.

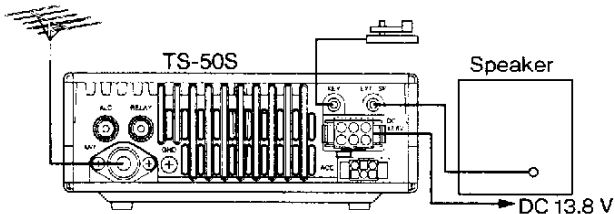

DC POWER SUPPLY CONNECTION

In order to use this transceiver for fixed station operation, you will need a separate 13.8 V DC power supply, which may be purchased separately. **DO NOT** attempt to directly connect the transceiver to an AC outlet!

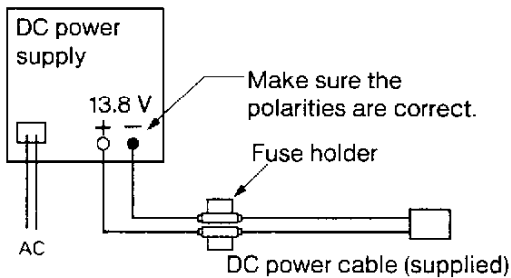

This transceiver draws less than 20.5 A (with an optional automatic antenna tuner, less than 22.5 A) when transmitting at full power output.

Kenwood recommends you use the optional DC power supply, model PS-33, which matches the electrical and cosmetic features of this transceiver.

Note:

- 1 Before connecting the DC power supply to the transceiver, be sure to switch the transceiver and the DC power supply off.
- 2 Do not plug the DC power supply into an AC outlet until you make all connections.
- 3 If the power supply voltage exceeds 18 V, the transceiver protection circuit will turn the power off automatically. The transceiver resumes operation automatically when the input voltage drops to 13.8 V.

● Installation example

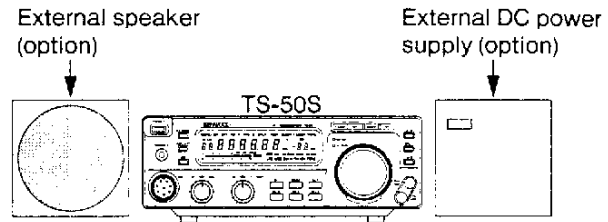

For a deluxe installation, take the time to install the transceiver in the mounting bracket. The diagram offers some mounting suggestions.

Added benefits of using the mounting bracket in your fixed station include the following:

- You can angle the transceiver for best visibility from your operating position.
- The transceiver remains stationary when you attach connectors or use any of the controls.
- The transceiver is quickly detachable from the bracket if you want to move it to your mobile or any other alternate operating position.
- The bracket eliminates the risk of anybody bumping the transceiver off your operating desk.

If you decide to mount the transceiver in a horizontal plane instead of angling it up or down, use the top or middle row of mounting holes on the bracket. The bottom row of holes cannot be used to mount the transceiver horizontally.

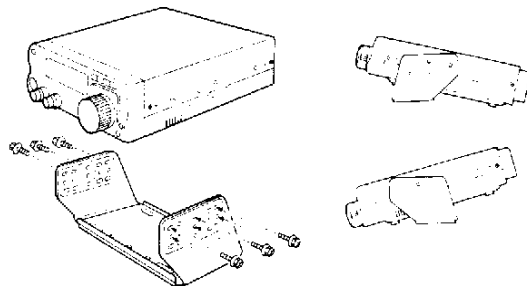

1 INSTALLATION AND CONNECTION

ANTENNA CONNECTION

The type of the antenna system, consisting of the antenna, ground, and feed, will greatly affect the successful performance of the transceiver. Use a properly adjusted antenna of good quality to let your transceiver perform at its best. Use a good quality 50 ohm coaxial cable and a first quality connector for the connection. Match the impedance of the coaxial cable and antenna so that the **SWR** is 1.5:1 or less. All connections must be clean and tight.

While the transceiver's protection circuit will activate if the **SWR** is greater than 2.5:1, do not rely on protection to compensate for a poorly functioning antenna system. High **SWR** will cause the transmitter output to drop, and may lead to radio frequency interference to both consumer products (such as stereo receivers and televisions), and RF interference to the transceiver itself. Reports that your signal is garbled or distorted, especially at peak modulation, may indicate that your antenna system is not efficiently radiating the transceiver's power. If, when you modulate, you feel a tingle from the transceiver's cabinet or the microphone's metal fittings, you can be certain that at the least, your coax connector is loose at the rear of the radio, and at the worst, your antenna system is not efficiently radiating power.

Caution: In a fixed station installation, use a lightning arrester to prevent fire, electric shock, or damage to the transceiver.

Using the optional auto antenna tuner allows the transceiver to perform at its very best. For additional information on the antenna tuner, refer to "AUTOMATIC ANTENNA TUNER" on page 48.

GROUND CONNECTION

At the minimum, a good DC ground is required to prevent such dangers as electric shock. For superior communications results, a good RF ground is required, against which the antenna system can operate. Both of these conditions can be met by providing a good earth ground for your station. Bury one or more ground rods, or a large copper plate under the ground, and connect this to the transceiver GND terminal. Use heavy gauge wire or a copper strap, cut as short as possible, for this connection. Just as for antenna work, all connections must be clean and tight.

Caution: DO NOT attempt to use a gas pipe (which is clearly dangerous), an electrical conduit (which has the whole house wiring attached and may act like an antenna), or a plastic water pipe for a ground.

1 INSTALLATION AND CONNECTION

ACCESSORY CONNECTIONS

External Speaker

Ensure any external speaker used has an impedance from 8 to 16 ohms. Use a 3.5mm mono (two conductor) plug.

Headphones

Use headphones having 4 to 32 ohms impedance. You can also use stereo headphones. When headphones are used, no sound is heard from the internal (or optional external) speaker. Use a 3.5mm mono (two conductor) or stereo (three conductor) plug.

Microphone

To communicate in the voice modes, connect a microphone having an impedance of 600 ohms to the **MIC** jack. Optional microphones include the MC-43S, MC-60S8, MC-80, and MC-85. Do not use the MC-44, MC-44DM, MC-45, MC-45E, MC-45DM or MC-45DME microphone.

Key or Electronic Keyer

Connect your key or electronic keyer to the **KEY** jack on the rear panel. Use a 3.5mm mono (two conductor) plug.

When using an electronic keyer, ensure the keyer wiring polarity is correct.

IF-10D Interface Connector

The IF-10D Interface is an optional accessory used to control the TS-50S transceiver from a computer.

The interface connector access hole is located in the bottom cover of the transceiver. The hole is covered by a circular protective patch that can be removed easily by prying up on the patch's edge with a fingernail. Use care not to scratch the bottom cover if any tool is used to remove the patch.

Removing the patch cover exposes the 6-pin male connector (CN6) to which the IF-10D Interface can be connected. Refer to the IF-10D Instruction Manual for further information on using this interface.

Plug wiring

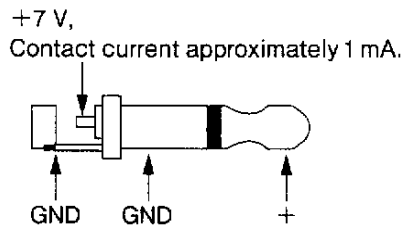

2 CONTROLS AND CONNECTORS

FRONT PANEL CONTROLS

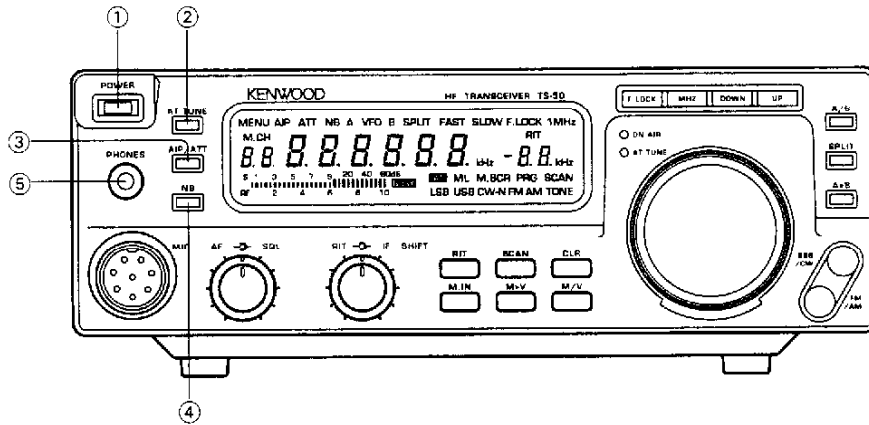

① POWER switch

Press momentarily to switch the transceiver on or off.

After the power is switched on, "HELLO" appears on the display for one second, followed by the frequency and other information such as mode and **VFO A** or **B**.

Note: When you switch the DC power supply on, you will not switch the transceiver on. Press the transceiver **POWER** switch to control its power.

② AT TUNE button

Press to activate the optional automatic antenna tuner (if connected).

The transceiver automatically checks whether the antenna tuner is connected when the power is switched on. Therefore, be sure to connect or disconnect the antenna tuner with the power off.

③ AIP/ATT button

Activates the AIP (Advanced Intercept Point) or ATT (Attenuator) function, or both simultaneously. Initially, or after a partial or full CPU reset, AIP is off above 9.5 MHz and on below 9.5 MHz. However, the default for ATT is off on all frequencies. With each press, the setting changes in sequence.

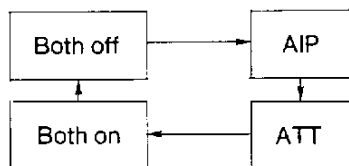

The status displays at the **LCD** top left. (Nothing displays when both functions are off.)

AIP helps eliminate radio interference, and moderates receiver audio distortion which sometimes occurs when receiving a strong signal.

ATT attenuates all received signals by 20 dB (1/10) to moderate interference by strong signals on adjacent frequencies.

The MC-47 microphone allows separate **ATT** and **AIP** selection. For **PF** (Programmable Function) key information, refer to "Programmable Function Keys" on pages 49 and 50.

④ NB button

Toggles the noise blanker.

The noise blanker attenuates pulse noise, such as that caused by automobile ignitions or a sparking electric motor.

For details, refer to "Noise Blanker" on page 43.

⑤ PHONES jack

Insert the headphones plug into this jack. Any headphones with an impedance of 4 to 32 ohms, including stereo headphones, may be used. Use a 3.5mm mono (two conductor) or stereo (three conductor) plug.

When using headphones, no sound will be heard from the internal (or external) speaker.

Note: When connecting headphones, insert the plug straight into the jack without applying sideways force that could damage the jack.

2 CONTROLS AND CONNECTORS

FRONT PANEL CONTROLS

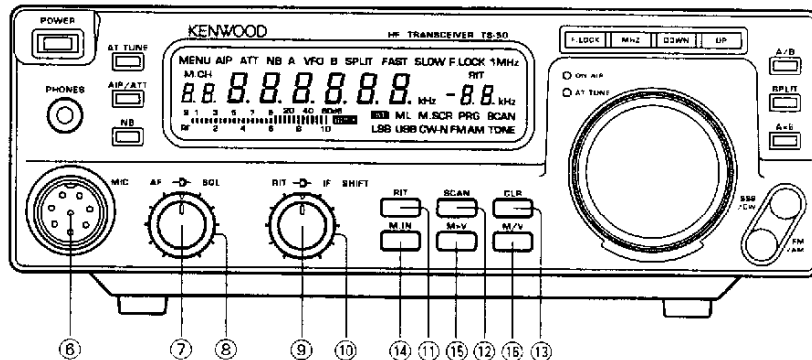

⑥ MIC connector

Connect the microphone securely.

⑦ AF control

Adjusts the receiver audio volume.

Note: The "beep" (audio annunciator) and sidetone levels are not affected by the position of the AF control.

⑧ SQL control

Turn to just eliminate the background noise when no signal is present, or set and forget at full counterclockwise rotation.

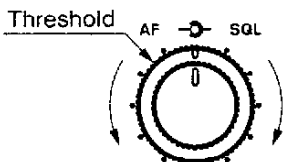

When the Squelch control is adjusted correctly, you will hear sound only when the other station is transmitting.

The point at which ambient noise just disappears (the threshold) depends on the modulation mode and frequency.

When receiving a weak signal, turn the control fully counterclockwise.

Note: If the Squelch control is turned fully clockwise, you may mistakenly think that receiver sensitivity is low or the transceiver is failing to output sound. Normally, the Squelch control should be set at the fully counterclockwise position unless in the FM or AM mode.

⑨ RIT control

The Receiver Incremental Tuning control has two functions:

- Receiver frequency shift
- Scan speed change

(1) Receiver frequency shift

With the **RIT** on, the receiver frequency is adjustable without affecting the transmitter frequency. Turn the **RIT** control clockwise, and the frequency will shift up.

For details, refer to "RIT Operation" on page 41.

(2) Scan speed change

Using the **RIT** control, the scan speed can be changed during memory or program scan. Turn the **RIT** control counterclockwise, and the scan speed will increase. When exiting scan, center the **RIT** control.

For details, refer to page 40.

Note: Remember that the RIT control affects both the receiver frequency shift, and scan speed. If you switch the RIT on after using the scan, the receiver frequency may be shifted.

⑩ IF SHIFT control

Allows shifting of an interfering signal outside the filter pass band to reduce or eliminate the adjacent signal interference.

Normally, set the control to the center (detent) position.

For details, refer to "IF Shift" on page 43.

Note: The IF SHIFT control functions in the SSB and CW modes, and does not function in the AM and FM modes.

2 CONTROLS AND CONNECTORS

⑪ RIT button

Toggles the Receive Incremental Tuning function. The RIT control adjusts the receiver frequency without affecting the transmitter frequency.

For **RIT** operation, refer to page 41.

⑫ SCAN button

This button provides three functions:

- Memory scan start
- Program scan start
- Scan stop

For Memory scan, refer to page 37. For Program scan, refer to page 39.

- (1) Memory scan start
Press the **SCAN** button in the Memory Channel mode to scan the memory channels.
- (2) Program scan start
Press the **SCAN** button in the **VFO** mode, and the transceiver scans within the range you have preset and stored in memory channel 99. If nothing has been preset in memory channel 99, scan ascends from the displayed frequency and scans the range from 30 kHz to 29.999.9 MHz.
- (3) Memory or program scan stop
Press the **SCAN**, **CLR** or microphone **PTT** button to stop scan.

⑬ CLR button

The **CLR** button provides six functions, depending on how you are operating:

- Memory or program scan stop
 - Memory Scroll mode exit
 - Memory channel lock-out
 - Memory channel clear
 - Menu Set-up exit
 - Automatic Power Off reset
- (1) Memory or program scan stop
Press the **CLR** button to stop Memory or Program scan.
For Memory scan, refer to page 37. For Program scan, refer to page 39.
 - (2) Memory Scroll mode exit
Press the **CLR** button to exit the Memory Scroll mode.
 - (3) Memory channel lock-out
During Memory scan, loaded channels can be skipped without erasing their contents. For details, refer to page 38.

Note: Press the CLR button for more than 2 seconds to erase the contents of a memory channel.

(4) Memory channel clear

A memory channel which contains unwanted data can be cleared. Select the memory channel to be cleared and press the **CLR** button for more than 2 seconds.

If you have set Memory Protect 1 or 2 on, you cannot clear memory channels. For details, refer to page 34.

(5) Menu Set-up exit

Press the **CLR** button to exit from the Menu Set-up mode, and return to the previous mode. For Menu Set-up functions, refer to pages 46 and 47.

(6) Automatic Power Off reset

Press the **CLR** button to reset the Automatic Power Off function. (If you do not operate any of the transceiver's controls for approximately 180 minutes, the power is automatically switched off.)

For details, refer to page 42.

⑭ M.IN button

This button provides these two functions:

- Memory channel storage
 - Memory Scroll mode
- (1) Memory channel storage
In the **VFO** or Memory Channel mode, stores the currently displayed data (e.g. frequency, modulation mode) into a memory channel. For details, refer to page 31.
 - (2) Memory Scroll mode
Press the **M.IN** button to enter the Scroll mode, and select a memory channel with the **UP** or **DOWN** button.

For details, refer to page 33.

⑮ M > V button

Transfers the currently displayed memory contents (frequency, modulation mode, etc.) to the VFO. For details, refer to "MEMORY TRANSFER" on page 33.

⑯ M/V button

Switches the transceiver between the **VFO** and Memory Channel modes. In the **VFO** mode, either **A VFO** or **VFO B** will appear at the display top center, depending on the last VFO used. When the Memory Channel mode is selected, **M.CH** appears at the display left.

2 CONTROLS AND CONNECTORS

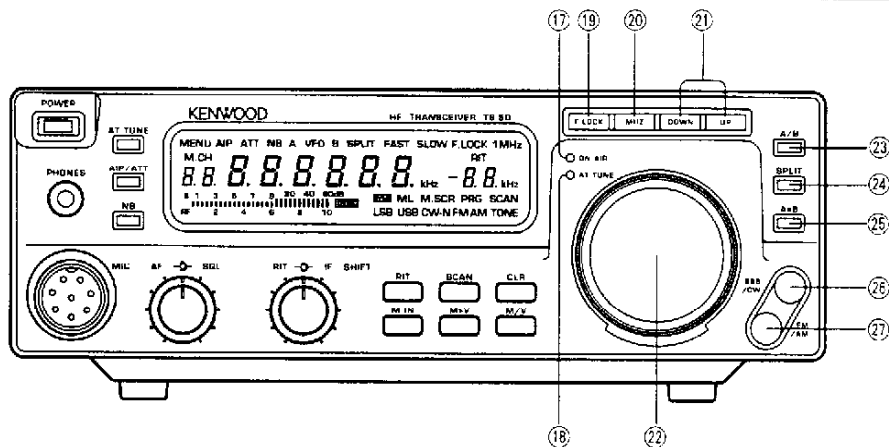

17 ON AIR indicator

Lights when the transceiver is both in the transmit mode and tuned to a frequency within a transmit band. Transmission is only possible within specific bands of frequencies; however, reception is possible on all frequencies tuned by the transceiver. If the microphone PTT switch is pressed while tuned to a frequency outside a transmit band, no signal can be transmitted. The PTT must be released first, a frequency tuned within a transmit band, and the PTT pressed again before transmission is possible.

18 AT TUNE indicator

Lights during preset or tuning of the optional automatic antenna tuner (AT-50 or AT-300). The LED goes off when tuning is finished.

19 F.LOCK button

Locks or unlocks the tuning control and these buttons:

- A/B
- A=B
- CLR
- DOWN
- FM/AM
- M.IN
- M/V
- M > V
- MHz
- SCAN
- SPLIT
- SSB/CW
- UP
- NB

Press this button momentarily, and "F.LOCK" appears on the display top right, to indicate that lock is on. Release lock by again pressing the button.

Note: When the F.LOCK button is depressed for more than two seconds, the transceiver will enter the Menu Set-up mode. Then the button will not function as the F.LOCK button. For the Menu Set-up mode, refer to pages 46 and 47.

20 MHz button

Toggles the function of the UP and DOWN buttons. The "1 MHz" indicator appears at the top right of the LCD to indicate status.

Switch the MHz button on:

In the VFO mode, to change the operating frequency in 1 MHz steps (1 MHz on).

In the Memory Channel mode, to select either from only loaded memory channels (on), or from all memory channels (off). For details, refer to "QUICK MEMORY CHANNEL SELECT" on page 36.

In the Memory Scroll mode, to select only from empty memory channels. For details, refer to "QUICK MEMORY CHANNEL SELECT" on page 36.

21 UP and DOWN buttons

The UP and DOWN buttons have these five functions:

- Amateur band select
 - Frequency up or down in 1 MHz steps
 - Memory channel select
 - Menu setting select
 - Start and end frequency recall (when memory channel 99 is selected)
- (1) Amateur band select
In the VFO mode, with the 1 MHz indicator off, step through the Amateur bands. Press the UP button, and the next higher band will be selected. Select the next lower band by pressing the DOWN button. Hold down either button for rapid change.
 - (2) Frequency up or down in 1 MHz steps
In the VFO mode, with the 1 MHz indicator on, step the frequency up or down in 1 MHz steps. Press the UP button to increase, or the DOWN button to decrease the frequency. Hold down either button for rapid change.

Note: The frequency step may be changed from 1 MHz to 500 kHz. For details, refer to Menu Set-up (Menu B, No. 62) on page 47.

2 CONTROLS AND CONNECTORS

- (3) **Memory channel select**
In the Memory Channel or Memory Scroll mode, select a memory channel with the **UP** or **DOWN** button.

Press the **UP** button to select the next higher memory channel, or the **DOWN** button for the next lower memory channel.

Hold down either button for rapid change.

For details, refer to page 33.
- (4) **Menu setting select**
Change the settings of Menu items using the **UP** or **DOWN** button. With each button press, the transceiver steps through the available selections.

For details, refer to Menu Set-up on pages 46 and 47.

Hold down either button for rapid change.
- (5) **Start and end frequency recall**
In the Memory Channel mode, switch the display between the program scan start and end frequencies when memory channel 99 is selected.

For example, to display the scan end frequency, press the **F.LOCK** button, then the **UP** button to see the end frequency. Then, press the **DOWN** button to switch to the start frequency. For details, refer to page 38.

②② Tuning control

The tuning control provides two functions:

- Frequency change
- Menu number select

The turning torque can be adjusted by using the drag control lever located at the bottom of the tuning control. Move the lever to the left to decrease drag, or to the right to increase drag.

- (1) **Frequency change**
In the **VFO** mode, turn the tuning control to change the operating frequency.

Fuzzy logic control

The frequency step changes automatically, depending on how fast the control is turned. At the slowest turning speed, the minimum step is 5 Hz. The frequency step during rapid tuning can be up to 200 Hz. In the FM mode, the range is from 50 Hz to 2 kHz.

- (2) **Menu number select**
In the Menu Set-up mode, choose the menu number with the tuning control.

For Menu Set-up, refer to pages 46 and 47.

②③ A/B button

Provides three functions, depending upon current operation:

- **A VFO** or **VFO B** select
- Transceiver Partial reset
- Menu **A** or Menu **B** select
(For Menu Set-up, refer to pages 46 and 47.)

- (1) **A VFO** or **VFO B** select
In the **VFO** mode, select either **A** or **B** as the active **VFO**. Either **A VFO** or **VFO B** appears at the display top center.
- (2) **Transceiver Partial reset**
If the transceiver will not respond to its controls, you may restore normal operation with the **A/B** button.

With the power supply on, and the transceiver power off, hold down the **A/B** button and switch the transceiver power on.

Note: If the transceiver still does not function properly, do a full reset using the **A=B** button. Full reset is described later.

For details, refer to "MICROPROCESSOR RESET" on page 45.

②④ SPLIT button

Permits use of the alternate (unused) VFO for the transmit frequency.

Press this button, and the **SPLIT** indicator will appear at the display top center to show that the alternate VFO will be used for the transmit frequency.

With the **SPLIT** button on, switch the **F.LOCK** on to activate the **TF-SET** function.

For split-frequency and **TF-SET** function details, refer to page 30.

②⑤ A=B button

This button provides two functions:

- **A=B** (equalize)
- Transceiver Full reset

- (1) **A=B**
In the **VFO** mode, copy the contents of the active VFO to the inactive (alternate) VFO.
- (2) **Transceiver Full reset**
All user specified data (memory channels and Menu items) will be initialized (reset to the factory defaults).

2 CONTROLS AND CONNECTORS

With the power supply on, and the transceiver power off, hold down the **A=B** button, and switch the transceiver power on. Refer to "MICROPROCESSOR RESET" on page 45.

②⑥ **SSB/CW button**

Switches the transceiver between SSB and CW modes, with a choice of two setup configurations. Switch to other modulation modes only while in receive mode.

By setting Menu **A**, No. 04, you can select either two-step switching (the default, which is the conventional **SSB** mode for the selected Amateur band, and **CW**) or three-step switching (**USB**, **LSB**, and **CW**).

For details, refer to Menu Set-up (Menu **A**, No. 04) on page 46.

A Two-step switching:

Press the **SSB/CW** button, and switch between **SSB** and **CW**.

LSB/USB Auto Select

In the **SSB** mode, the transceiver automatically selects **USB** or **LSB**, depending upon whether the operating frequency is higher or lower than 9.5 MHz.

By convention, **LSB** is used for the 1.8 MHz through 7 MHz bands, and **USB** is used for the 14 MHz and higher bands.

B Three-step switching:

Press the **SSB/CW** button, and step through **USB**, **LSB**, and **CW**.

Note: In the Memory Channel mode, if the modulation mode is changed after selecting a channel, the change is temporary, and the previous data in that channel remains unchanged. However, if the mode is changed with memory channel 99 selected, the previous data is overwritten in memory channel 99.

②⑦ **FM/AM button**

Toggles the transceiver between **FM** and **AM**. Switch to other modulation modes only while in receive mode.

Note: In the Memory Channel mode, if the modulation mode is changed after selecting a channel, the change is temporary, and the previous data in that channel remains unchanged. However, if the mode is changed with memory channel 99 selected, the previous data is overwritten in memory channel 99.

2 CONTROLS AND CONNECTORS

REAR PANEL CONNECTORS

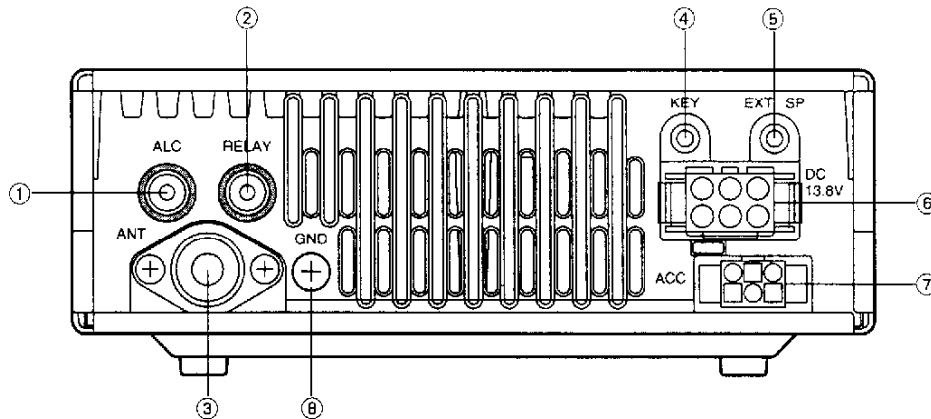

① ALC

Input for an external ALC signal from a linear amplifier. Requires a standard audio (phono) plug.

② RELAY

During transmit, used to key a linear amplifier by providing a switch to ground from a built-in relay. Requires a standard audio (phono) plug.

③ ANT

Connect to an external antenna, an antenna tuner, or a dummy load. Use a 50 ohm **HF** antenna and feed system, with a PL-259 (M type) coaxial connector.

④ KEY

Connect a key for **CW** operation. Use a 3.5 mm diameter plug.

Turn the transceiver power off before inserting the plug.

The transceiver will momentarily transmit if the key is inserted with the power on.

⑤ EXT SP

Connect an optional external speaker, using a 3.5 mm diameter plug. This will disconnect the internal speaker.

⑥ Power Input DC 13.8 V

Connect to a 13.8 V DC supply to power the transceiver. Use the supplied DC cable. This transceiver draws less than 20.5 A (with an automatic antenna tuner, less than 22.5 A) at maximum transmitter output.

⑦ ACC

Connect the optional automatic antenna tuner (AT-50 or AT-300). For details, refer to "AUTOMATIC ANTENNA TUNER" on page 48.

⑧ GND

Connect a heavy gauge wire or copper strap between the ground terminal and the nearest earth ground. Do not connect the ground wire to either your house electrical wiring, or gas or water pipes. A well grounded transceiver will reduce the risk of interference to television or broadcast radio receivers. It can also reduce receiver noise caused by static discharges.

2 CONTROLS AND CONNECTORS

DISPLAY

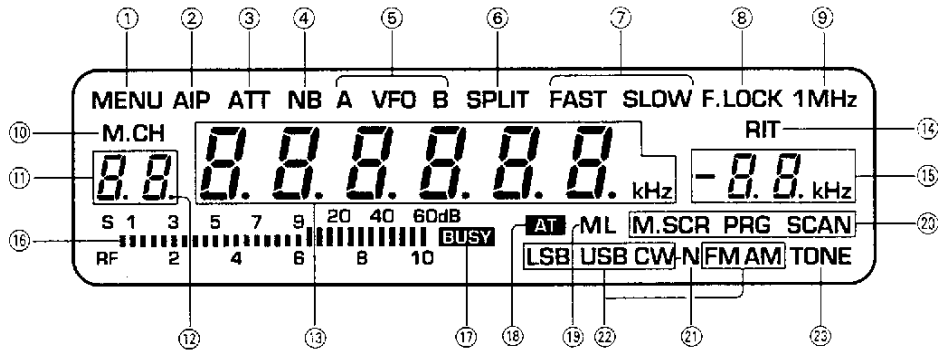

① MENU

Appears when entering the **MENU** Set-up mode.

② AIP

Appears when the **Advanced Intercept Point** function is selected with the **AIP/ATT** button.

③ ATT

Appears when the **ATTenuator** is selected with the **AIP/ATT** button.

④ NB

Appears when the **Noise Blanker** is on.

⑤ A VFO B

Either **A VFO** or **VFO B** appears, depending on which VFO is selected with the **A/B** button.

⑥ SPLIT

Appears when the **SPLIT** frequency function is on.

⑦ FAST/SLOW

Either **FAST** or **SLOW** appears, depending on which **AGC** speed is selected. (No indicator appears in the **FM** mode.)

⑧ F.LOCK

Appears when the **F**requency **L**OCK function is on.

⑨ 1MHz

Appears when the **MHz** function is on. Also appears in the Memory Channel mode when selecting from only programmed channels, or the Memory Scroll mode when choosing empty memory channels.

⑩ M.CH

Appears after switching to the **M**emory **C**hannel mode using the **M/V** button.

⑪ Memory channel display

Displays the selected memory channel number.

⑫ Dot

Appears when memory channels are locked-out. Refer to Memory Channel Lock-out, on page 38.

⑬ Digital frequency display

Displays the operating frequency.

⑭ RIT

Appears when **R**eceiver **I**ncremental **T**uning is on.

⑮ Digital RIT display

Displays the amount of frequency shift with the **RIT** on, the scan speed value during scan, or the one and ten Hertz frequency digits when using the MC-47.

2 CONTROLS AND CONNECTORS

⑩ Meter

Appears as the Peak Hold **S** meter (S1 to 60 dB) during reception, and as the Peak Hold **RF** meter (to 10) during transmission. The peak hold characteristic can be disabled by menu selection if required.

The **RF** meter also can deflect times four (4X) when low power is selected. For details, refer to "Menu Set-up" (Menu **A**, No.14 and Menu **B**, No.55) on pages 46 and 47.

⑪ BUSY

Appears when the squelch is opened, either by the **SQL** control, or by a received signal.

⑫ AT

Appears when an optional Automatic **Antenna Tuner** (AT-50 or AT-300) is connected. When using the AT-50, this indicator appears when the AUTO/THRU switch on the tuner is in the AUTO position.

⑬ M/L

Appears when **Medium** or **Low** transmitter output power is selected using the Menu Set-up. No designator indicates full power.

⑭ M.SCR/PRG/SCAN

Appears when the M.IN button is pressed to activate the **Memory SCR**oll function. **PRG** appears after selecting memory channel 99. **PRG** and **SCAN** both appear during program scan. **SCAN** appears during memory scan.

⑮ -N

Appears when an optional **Narrow** filter is selected using the Menu Set-up. For details, refer to "IF Filter" on page 43.

⑯ LSB/USB/CW/FM/AM

A modulation mode appears depending upon which you select using the **SSB/CW** or **FM/AM** button.

⑰ TONE

Appears when either the burst, or continuous subaudible **TONE** for 10 meter operation is on. Both the **FM** mode and **SPLIT** transmit/receive operation must be selected to use the tone encoder.

3 COMMUNICATION

CONFIRMATION BEFORE OPERATION

Before operation, confirm that all connections and settings are ready, according to this checklist:

Rear panel:

- 1 Antenna: Is it really connected (including any coax switches)?
- 2 DC power cable: Connected and locked in place? (Do not turn on the DC power supply yet.)
- 3 Ground: Is the transceiver actually grounded?

Caution: DO NOT transmit without an antenna connected to the ANT connector. The transceiver can fail. Be certain to connect the correct cable, for the right antenna, for the band you intend to operate. See Rear panel checklist, step 1.

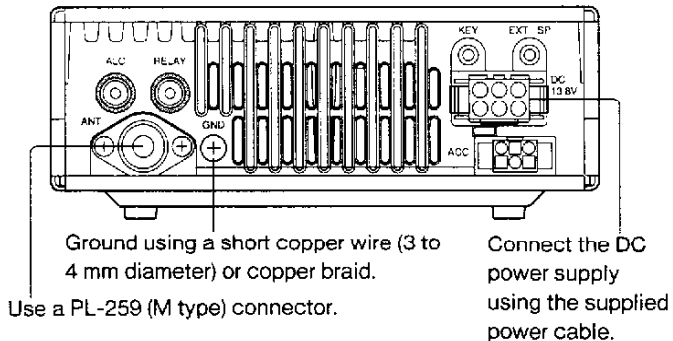

Front panel:

- 1 Front panel controls: Are they preset?
- 2 Microphone: Is the connector fully inserted and snugly screwed down?

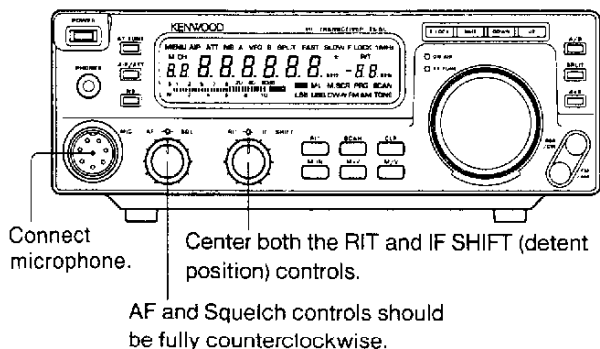

SSB OPERATION

RECEPTION

- 1 Switch on the DC power supply, and then switch on the transceiver.
- 2 After the "HELLO" message, the frequency and the other indicators will appear on the display.



- 3 Select the receive frequency using the **UP** and **DOWN** buttons and the tuning control. The frequency may be changed in 1 MHz steps using the **UP** or **DOWN** button (1 MHz indicator on).
- 4 Select the **SSB** mode with the **SSB/CW** button.

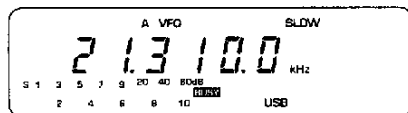

LSB or **USB** is automatically selected with 9.5 MHz as the switch over point.

- 5 Set the **AF** control to a comfortable listening level.
- 6 If desired, adjust the **SQL** control until the noise just disappears (threshold).
- 7 Adjust the tuning control for clearest reception.

■ Narrow Filter (optional filter required)

With the optional 0.5 kHz filter installed, change Menu **A**, No. 03 to the narrow setting. However, the standard 2.4 kHz filter is recommended in the **SSB** mode. For Menu Set-up, refer to page 46.

When the 0.5 kHz optional filter is selected, the **-N** indicator appears on the bottom right of the display. However, if the optional 0.5 kHz filter is not installed, this selection has no effect.

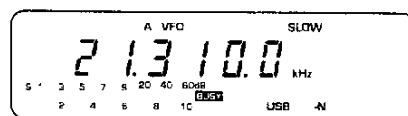

The filter selection remains on until the setting is changed.

TRANSMISSION

- 1 Plug the microphone in and secure the connector.
- 2 Select the transmit frequency using the **UP** and **DOWN** buttons and the tuning control. Press the **MHz** button to change the frequency in 1 MHz steps with the **UP** or **DOWN** button (1 MHz indicator is on).
- 3 Use the **SSB/CW** button to select the **SSB** mode. **LSB** or **USB** is selected automatically with 9.5 MHz as the switch over point.
- 4 Hold the microphone **PTT** (Push To Talk) switch to transmit. Be courteous; make sure that your transmission doesn't interfere with others.
- 5 Speak into the microphone.

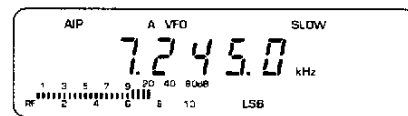

Note: Speak in a normal tone of voice. The RF meter should indicate from 5 to 7 on voice peaks when using high (100 W) power. The meter will read lower when either the medium (50 W) or low (10 W) power levels are used. Speaking too close to the microphone, or too loudly may increase distortion and reduce intelligibility.

- 6 Release the **PTT** switch to receive.

■ Microphone Gain Change

Microphone gain can be selected by changing Menu **B**, No. 66. Refer to Menu Set-up on page 47. Also see page 54, "Adjustments", Microphone gain VR7 (SSB and AM) and VR1 (FM).

The default is Low (L). High (H) will increase microphone gain.

3 COMMUNICATION

CW OPERATION

RECEPTION

- 1 Switch on the DC power supply, and then switch on the transceiver.
- 2 After the "HELLO" message, the frequency and the other indicators will appear on the display.

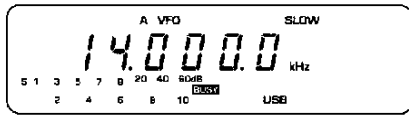

- 3 Select the receive frequency using the **UP** and **DOWN** buttons and the tuning control.

The frequency may be changed in 1 MHz steps using the **UP** or **DOWN** button (1 MHz indicator on).

- 4 Use the **SSB/CW** button to select the **CW** mode.



- 5 Set the **AF** control to a comfortable listening level.
- 6 If desired, adjust the **SQL** control until the noise just disappears (threshold).
- 7 Adjust the tuning control for clearest reception.

■ CW Pitch Change

The **CW** receive pitch can be selected from the range of 400 Hz to 1000 Hz in 50 Hz steps, by changing Menu **A**, No. 06. 800 Hz is the default. For details, refer to Menu Set-up on page 46.

Changing this setting does not affect the transmit sidetone.

■ CW Reverse (CW-R)

This function switches receive from the default upper sideband to the opposite carrier point, or lower sideband.

Therefore, interference heard in the default **CW** mode (USB) may be avoided by switching Menu **A**, No. 07 to the Reverse **CW** (LSB) receive mode.

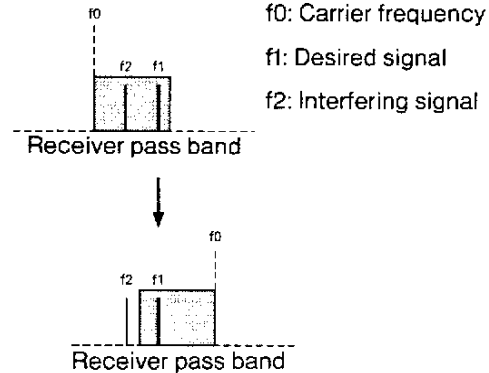

The pitch becomes higher as the tuning control is turned clockwise (the receive frequency increases). When your receive frequency is identical to the transmit frequency of the other station, the **CW** Reverse function has no effect on receive tone or your transmit frequency (in the above figures, f_1 (desired frequency)).

Once **CW-R** is selected, it remains on until it is turned off, or the transceiver is reset using the **A=B** button.

■ CW Narrow

Interference can be reduced or eliminated by installing the optional 0.5 kHz filter and changing the Menu **A**, No. 03 selection. For optional filter installation, refer to page 55. For selection detail, refer to Menu Set-up on page 46.

TRANSMISSION

- 1 Switch off the transceiver.
- 2 Plug a key or electronic keyer into the rear panel **KEY** jack.
- 3 Switch on the transceiver.
- 4 Select a transmit frequency using the **UP** and **DOWN** buttons and the tuning control.

Use the **UP** and **DOWN** buttons with the **MHz** button on (1 MHz displayed) to change frequency in 1 MHz steps.

- 5 Use the **SSB/CW** button to select **CW**.
- 6 Operate the key or the electronic keyer to transmit. Before transmitting, check that you will not interfere with other stations.

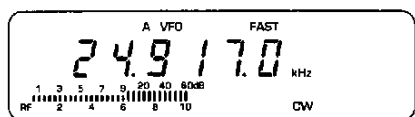

■ Delay Time Change

Menu **A**, No. 05 allows keying delay time selection (the delay before the transceiver returns to the receive mode after the key is released). The default is 600 ms. For details, refer to Menu Set-up on page 46.

Rear panel

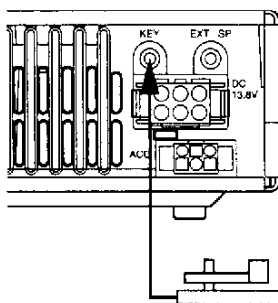

Switch the power off before connecting a key to the **KEY** jack. Installing a key into this jack with the power on will cause the transceiver to momentarily transmit.

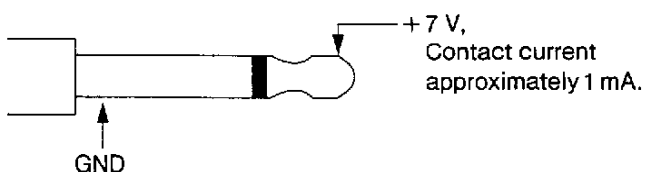

Use a commercially available 3.5mm plug to connect a keying device.

3 COMMUNICATION

FM OPERATION

RECEPTION

- 1 Switch on the DC power supply, and then switch on the transceiver.
- 2 After the "HELLO" message, the frequency and the other indicators will appear on the display.



- 3 Select the receive frequency using the **UP** and **DOWN** buttons and the tuning control. 29.0 through 29.7 MHz is normally used for FM operation.

The frequency may be changed in 1 MHz steps using the **UP** or **DOWN** button (1 MHz indicator on).

- 4 Use the **FM/AM** button to select the **FM** mode.

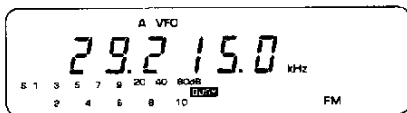

- 5 Set the **AF** control to a comfortable listening level.
- 6 **FM** background noise will be heard when no signal is present. Adjust the **SQL** control until the noise just disappears (threshold).
- 7 Adjust the tuning control for clearest reception. Ten meter **FM** is usually channelized, similar to the **VHF** and **UHF** bands. Refer to the ARRL Repeater Directory or similar reference for simplex and repeater frequencies (and tone frequencies)

TRANSMISSION

- 1 Plug the microphone in and secure the connector.
- 2 Use the **UP** and **DOWN** buttons and the tuning control to select the transmit frequency. 29.0 through 29.7 MHz is normally used for FM operation.

The frequency may be changed in 1 MHz steps using the **UP** or **DOWN** button (1 MHz indicator on).

- 3 Use the **FM/AM** button to select the **FM** mode.
- 4 Hold the microphone **PTT** switch to transmit.
Be courteous; make sure that your transmission doesn't interfere with others.
- 5 Speak into the microphone.

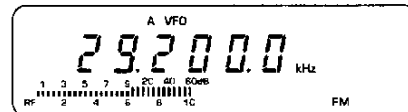

Note: Speak in a normal tone of voice. The RF meter will indicate a steady carrier, regardless of voice peaks.

Speaking too close to the microphone, or too loudly may increase distortion and reduce intelligibility. If operating through a repeater, over deviation will cause your signal to "talk-off" (break up) through the repeater.

- 6 Release the **PTT** switch to receive.

AM OPERATION

RECEPTION

- 1 Switch on the DC power supply, and then switch on the transceiver.
- 2 After the "HELLO" message, the frequency and the other indicators will appear on the display.



- 3 Select the receive frequency using the **UP** and **DOWN** buttons and the tuning control.

The frequency may be changed in 1 MHz steps using the **UP** or **DOWN** button (1 MHz indicator is on).

- 4 Use the **FM/AM** button to select the **AM** mode.

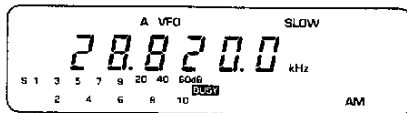

- 5 Set the **AF** control to a comfortable listening level.
- 6 Adjust the **SQL** control until the noise just disappears (threshold).
- 7 Adjust the tuning control for clearest reception.
- 8 Use the **AIP/ATT** button if overload or distortion is heard on a strong signal.

■ Narrow Filter

The 2.4 kHz **SSB** filter can be selected by changing Menu **A**, No. 03 to the narrow setting. However, the standard 6.0 kHz filter is recommended in the **AM** mode.

For Menu Set-up, refer to page 46.

When the 2.4 kHz filter is selected, the **-N** indicator appears on the bottom right of the display.

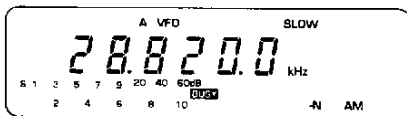

The new filter selection remains on until the setting is changed.

TRANSMISSION

- 1 Plug the microphone in and secure the connector.
- 2 Select the transmit frequency using the **UP** and **DOWN** buttons and the tuning control.

Press the **MHz** button to change the frequency in 1 MHz steps with the **UP** or **DOWN** button (1 MHz indicator is on).

- 3 Use the **FM/AM** button to select the **AM** mode.
- 4 Hold the microphone **PTT** switch to transmit.
Be courteous; make sure that your transmission doesn't interfere with others.
- 5 Speak into the microphone.

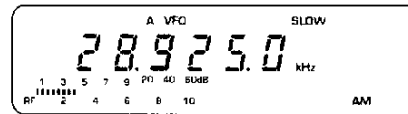

Note: Speak in a normal tone of voice. The RF meter should indicate 1 or 2 units higher on voice peaks than the carrier level reading. Speaking too close to the microphone, or too loudly may increase distortion and reduce intelligibility.

- 6 Release the **PTT** switch to receive.

■ Microphone Gain Change

Microphone gain can be selected by changing Menu **B**, No. 66. Refer to Menu Set-up on page 47. Also see page 54, "Adjustments", Microphone gain VR7 (SSB and AM) and VR1 (FM).

The default is Low (L). High (H) will increase microphone gain.

3 COMMUNICATION

DATA OPERATION (PACKET, AMTOR, RTTY)

Data communications over radio is easier and more fun than ever. For many, the excitement of amateur radio has returned due to active experimentation in the newest modes of digital communications.

RECEPTION

- 1 Connect your terminal node controller (TNC) signal cable to the **MIC** connector. Refer to the "MIC connector and TNC signal cable" diagram.
- 2 Switch on the DC power supply, and then switch on the transceiver.
- 3 After the "HELLO" message, the frequency and the other indicators will appear on the display.

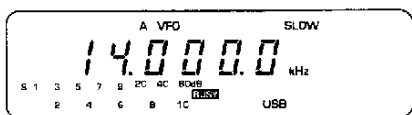

- 4 Select the receive frequency using the **UP** and **DOWN** buttons and the tuning control.

The frequency may be changed in 1 MHz steps using the **UP** or **DOWN** button (1 MHz indicator on).

- 5 Use the **SSB/CW** or **FM/AM** button to select the desired mode.

For digital operation, **SSB** or **FM** is used depending on the operating band, and **LSB** is most common for packet and RTTY. Refer to the table on page 28. For **AMTOR**, **USB** is normally used. Use Menu **A**, No. 4 with the **SSB/CW** button if it is necessary to select the opposite sideband. Refer to Menu Set-up on page 46.

- 6 Select **FAST AGC** for these digital modes using Menu **A**, No. 2. Refer to Menu Set-up on page 46.
- 7 Set the **AF** control at 10 o'clock, or as suggested by your **TNC** Instruction Manual.
- 8 Adjust the transceiver tuning control using the **TNC** tuning indicator. Refer to your **TNC** Instruction Manual for tuning indicator details.

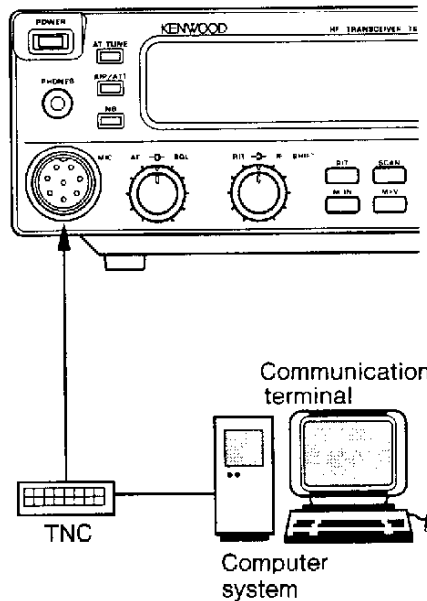

MIC connector and TNC signal cable

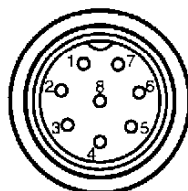

Viewed from the front

No.	Signal line name
1	TXD
2	Standby (PTT)
3	(Microphone, DOWN)
4	(Microphone, UP)
5	(Microphone, 8V)
6	RXD
7	(Microphone, GND)
8	GND

TRANSMISSION

- 1 Connect your terminal node controller (TNC) signal cable to the **MIC** connector.

Refer to "MIC connector and TNC signal cable" in "RECEPTION".

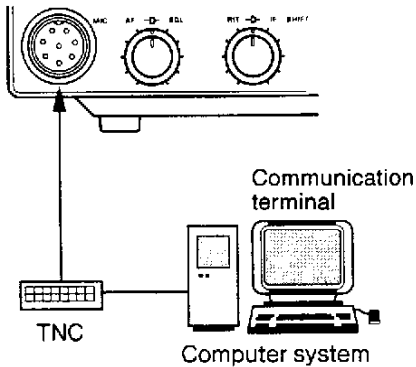

- 2 Select the transmit frequency using the **UP** and **DOWN** buttons and the tuning control.
Press the **MHz** button to change the frequency in 1 MHz steps with the **UP** or **DOWN** button (1 MHz indicator is on).
- 3 Use the **SSB/CW** or **FM/AM** button to select the desired mode. For packet operation, USB, LSB or FM is used depending on the operating band.
Refer to "RECEPTION", Item 5 on page 27.
- 4 Commands sent from your communication terminal (often a computer keyboard or a "dumb" terminal) to the TNC control the transmitter.

Refer to your TNC Instruction Manual.

Be courteous; make sure your transmission doesn't interfere with others. Although packet protocol can handle multiple stations on a single frequency, overall throughput decreases due to packet collisions.

- 5 Adjust the output level from the TNC while watching the RF meter to avoid output power saturation. On packet or AMTOR, adjust for a maximum meter reading of 10 with a steady mark or space. On RTTY, adjust the level for a maximum reading of 5 due to the higher duty cycle of this mode.

Packet Modulation

Shown below are the data rates and types of modulation used for HF packet operation:

Mode	Data rate	Modulation type
USB & LSB	300 baud (AFSK)	F1
USB & LSB	1200 baud (PSK)	F1
FM	1200 baud (AFSK)	F2

F2 modulation at 1200 baud may only be used on the 28 to 29.7 MHz band. Consult your national amateur radio organization to obtain band plans that specify where in each band various modes are used.

Frequency Readout

The transceiver displays the carrier frequency in the SSB mode. When transmitting with digital modes, the display frequency differs from the actual transmit frequency as follows:

USB: Displayed freq. + Modulation freq. = Actual freq.

LSB: Displayed freq. - Modulation freq. = Actual freq.

For example, to select an RTTY "mark" frequency of 14.080, an operator would tune 14.082.125 MHz on the transceiver if in the LSB mode.

LSB: 14.082.125 MHz - 2125 Hz = 14.080 MHz.

Refer to your TNC Instruction Manual for the audio modulation frequency for the mode used.

3 COMMUNICATION

FM REPEATER OPERATION

Compared to the usual simplex method of FM communications on HF, which is radio to radio with antennas at or slightly above average terrain, you can often transmit much farther through repeaters.

Repeaters are typically located on a mountain top or other elevated location. Most often they operate at a higher ERP (Effective Radiated Power) than the average mobile or fixed amateur station. This combination of elevation and high ERP allows communications over wider and longer distances than can be achieved by the average station.

HF repeaters operate only in the 29 MHz FM sub-band. This special service combines the advantages of FM operation, good fidelity with noise and interference immunity, with the excitement of HF DX (long distance) communications.

Even on a quiet day, 10 meter FM provides reliable around-town communications with the exciting potential for sudden DX from across the country, or around the world.

Note: Some 10 meter FM repeaters use CTCSS (Continuous Tone Coded Squelch System, also referred to as tone or "PL" [Private Line]) to prevent other repeaters on the same frequency from keying and locking each other up. If CTCSS is used by a repeater in your area, set both the tone frequency and tone type from Menu B, Nos. 53 and 54. The defaults are 88.5 Hz and C (continuous). Refer to the ARRL Repeater Directory or similar reference for tone information. For setup information, refer to "Menu Set-up" on page 47.

European Operation:

In Europe, a 1750 Hz tone is used to access repeaters. Although the required 1750 Hz burst tone can be generated using Menu B, Nos. 53 and 54, deviation has been adjusted for CTCSS repeaters. European applications may require the deviation to be adjusted. Consult your local Kenwood dealer if you wish to use the 1750 Hz tone feature.

- 1 Set the repeater receive frequency (your transmit frequency) and mode in **VFO A**.

Example: Set 29.580 MHz FM in **VFO A**.

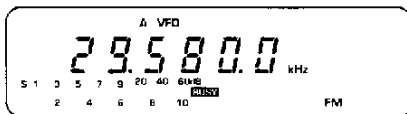

- 2 Press the **A/B** button to select **VFO B**.

- 3 Set the repeater transmit frequency (your receive frequency) and mode in **VFO B**.

Example: Set 29.680 MHz FM in **VFO B**.

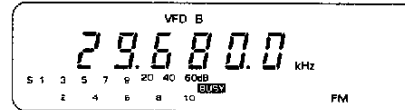

- 4 Press the **SPLIT** button. The **SPLIT** and **TONE** indicators appear on the display.

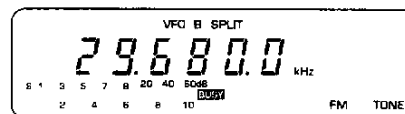

TONE turns on automatically whenever FM mode and split operation are selected unless Menu **A**, No. 15 is turned off. Select the desired tone frequency by using Menu **B**, No. 53. Use Menu **B**, No. 54 to choose either a burst or continuous tone.

- 5 Hold the **PTT** switch and speak into the microphone. Use the **M.IN** button to store the current settings in memory (channel 00 through 98).

Note:

- 1 Be sure your transmission does not interfere with others.
- 2 Speak in a normal tone of voice. The RF meter will indicate a steady carrier, regardless of voice peaks. Speaking too close to the microphone, or too loudly may increase distortion and reduce intelligibility. When operating through a repeater, over deviation will cause your signal to "talk-off" (break up) through the repeater.

- 6 Release the **PTT** switch to receive.

SPLIT-FREQUENCY OPERATION

Split-frequency operation uses one **VFO** for the receive frequency, and the other **VFO** for the transmit frequency. With the **SPLIT** button on, the **VFOs** switch automatically when the **PTT** switch is pressed or released. This allows you to move independently either **VFO** frequency without affecting the other.

When a rare or desirable station is heard, he or she may immediately get many responses, all at the same time. It quickly becomes difficult to separate and identify both the original calling station (usually a **DX** station), and the many responding stations. This "DX pileup" is exciting, but it is also very inefficient and frustrating. Often the **DX** station is lost under the noise and confusion of many calling stations.

If things grow out of hand, it is the **DX** station's responsibility to take control by announcing that he will be "listening up 5 (kHz, from his present transmit frequency)", or "listening down between 5 and 10 (kHz)". This usually means the **DX** station will not change his transmit frequency, but will begin Split operation in order to tune among the calling stations, pick out a callsign or two, and begin working those stations. Since, for the moment, the **DX** station is holding his transmit frequency, you should not change your receive frequency.

If you find that you are suddenly being called as that rare or desirable station, your ability to control the situation and complete contacts is much improved by "going to split".

- 1 Assume that you are receiving a **DX** station on 21.275 MHz using the **A VFO**.

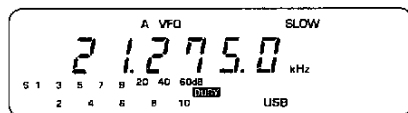

- 2 Press the **A=B** button to copy the contents of **A VFO** to **VFO B**.
- 3 Press the **A/B** button to select **VFO B**.
- 4 Tune **VFO B** to the desired split transmit frequency. Try to choose a clear frequency free of other stations.

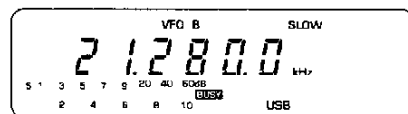

- 5 Press the **A/B** button again to return to **A VFO** for receive, and press the **SPLIT** button. The **SPLIT** indicator appears. Key the microphone (press the **PTT** switch). The transceiver switches between **VFO B** for transmit and **A VFO** for receive.
- 6 To end split-frequency operation, press the **SPLIT** button. The **SPLIT** indicator will clear, and the transceiver will return to the single **VFO** mode.

TF-SET (Transmit Frequency Set)

This function allows you to check or adjust your transmit frequency while operating split-frequency.

- 1 Momentarily press the **F.LOCK** button during split-frequency operation. The **F.LOCK** indicator appears and the receive **VFO** locks.
- 2 Hold the **SPLIT** button. The alternate **VFO** indicator appears, and you are listening now on the transmit **VFO**.
- 3 Use the tuning control while listening on the transmit **VFO** to locate and listen for the closing comments by the current station, or to find a clear frequency.

Releasing the **SPLIT** button lets you listen to the **DX** station on the receive **VFO**. Pressing and holding the **SPLIT** button lets you hear the station the **DX** is working. Hearing both sides of the conversation means you have a better chance to make your own transmission with perfect timing. A well-timed call is critical to catch the ear of the **DX** station.

- 4 To end TF-Set, press the **F.LOCK** button and unlock the receive **VFO**. To end split operation, press the **SPLIT** button.

4 MEMORY FEATURES

MICROPROCESSOR MEMORY BACKUP

This transceiver uses a lithium battery to retain the user-specified memory items. Switching the power off will not erase the Menu Set-ups or memory channels. Lithium battery life is approximately five years.

If you find the transceiver powers-up with default settings, and channel and VFO data is erased, have the lithium battery replaced. Contact an authorized KENWOOD service facility or dealer.

MEMORY CHANNEL DATA

There are 100 memory channels.

Channel No.	Function
00 through 98	Stores either simplex or split (duplex) frequencies.
99	Stores program scan start and end frequencies, or simplex frequencies.

The following can be stored in memory:

Yes: Can be stored
No : Cannot be stored

Parameter	Channels	Channel
	00~98	99
Transmit and receive frequencies	Yes	Yes
Modulation mode	Yes	Yes*
Filter bandwidth	Yes	Yes*
Scan start and end frequencies	No	Yes
AIP on or off	Yes	Yes*
ATT on or off	Yes	Yes*
Lock-out on or off	Yes*	Yes*
AGC fast or slow	Yes	Yes*
TONE frequency	Yes	Yes*

* If you change the setting after selecting a memory channel, the previous data for that setting will be overwritten.

MEMORY CHANNEL STORAGE SIMPLEX-FREQUENCY CHANNEL STORAGE

Store the same transmit and receive frequency in any memory channel (00 through 99) with this procedure:

- 1 Select a frequency, a modulation mode, and other data (as required).

Example: Select 14.175 MHz and **USB** in **A VFO**.

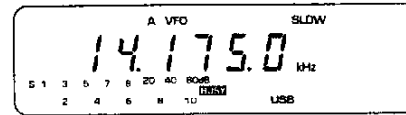

- 2 Press the **M.IN** button. The last memory channel number selected appears.

Example: Factory default

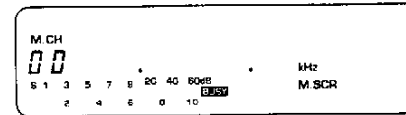

- 3 Select a memory channel using the **UP** or **DOWN** button.

Example: Select channel 7.

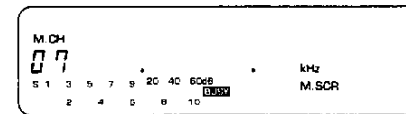

- 4 Press the **M.IN** button again. The displayed data is stored in the selected memory channel, and the transceiver returns to its previous settings.

Note: Pressing the **M.IN** button overwrites new data on any previous data in that channel.

To avoid accidental loss of data, there is a function which allows you to select only from among the empty channels. For the procedure, refer to page 36.

4 MEMORY FEATURES

SPLIT-FREQUENCY CHANNEL STORAGE

Store different transmit and receive frequencies in any memory channel (00 through 98) with this procedure:

- 1 Select the receive frequency, modulation mode, and other data (as required).

Example: Select 21.235 MHz and **USB** in **A VFO**.

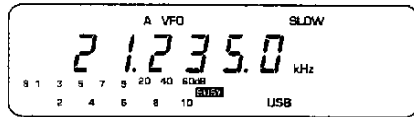

- 2 Press the **A/B** button to select **VFO B**.
- 3 Select the transmit frequency.

Example: 21.210 MHz in **VFO B**

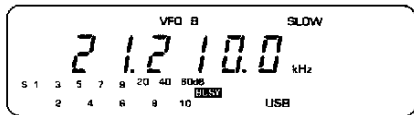

- 4 Press the **A/B** button again to select **A VFO**. The VFO selected here contains the frequency that will become the memory receive frequency after completing step 8 below. The other VFO's frequency will become the memory transmit frequency.
- 5 Press the **SPLIT** button. The **SPLIT** indicator appears.
- 6 Press the **M.IN** button. The last memory channel number selected appears.
- 7 Select a new memory channel using the **UP** or **DOWN** button.

Example: Select memory channel 8.

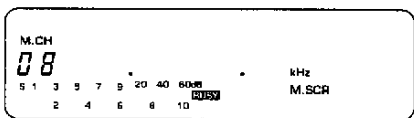

- 8 Press the **M.IN** button again. The data selected in steps 1 through 5 is stored in the selected memory channel, and the transceiver returns to its previous settings.

Note: Pressing the M.IN button overwrites new data on any previous data in that channel.

SCAN START AND END FREQUENCY STORAGE

Store program scan start and end frequencies in channel No. 99 with the following procedure. This channel can also be used as a simplex channel.

- 1 Select the scan start (or scan end) frequency.

Example: 7.030 MHz and **LSB** in **A VFO**

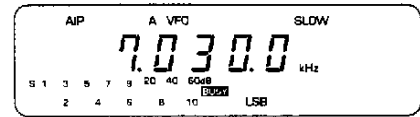

- 2 Press the **A/B** button to select **VFO B**.
- 3 Select the scan end (or scan start) frequency.

Example: 7.100 MHz and **LSB** in **VFO B**



- 4 Press the **A/B** button again to select **A VFO**. The VFO selected here contains the frequency that will become the scan start frequency after completing step 7 below. The other VFO's frequency will become the scan end frequency.
- 5 Press the **M. IN** button.
- 6 Select memory channel 99 using the **UP** or **DOWN** button.
- 7 Press the **M.IN** button again. The data selected in steps 1 through 4 is stored in the selected memory channel, and the transceiver returns to its previous settings.

Note: Pressing the M.IN button overwrites new data on any previous data in that channel.

■ Programmable VFO Function

When you select memory channel 99 (containing start and end frequencies), you can use the tuning control to change the operating frequency within that range, as if you were in the **VFO** mode.

To confirm the range, press the **F.LOCK** button, and then the **UP** or **DOWN** button to move to the scan limit frequencies.

This function can also be used during a contest, for example, to quickly change the operating frequency.

4 MEMORY FEATURES

MEMORY CHANNEL RECALL

Recall a memory channel with this procedure:

- 1 Press the **M/V** button to change from VFO to Memory Channel mode. The last memory channel number selected appears.

Example: Memory channel 99, containing 7.030 MHz

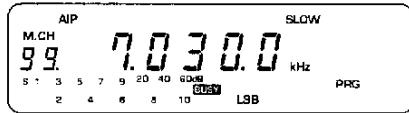

- 2 Select memory channel using the **UP** or **DOWN** button.

Example: Recall memory channel 7, containing 14.175 MHz.

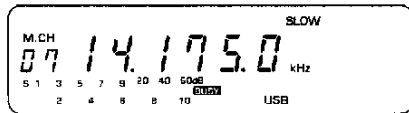

- 3 To return to the **VFO** mode, press either the **M/V** button, or the **M > V** button to transfer the memory data to the **VFO**.

Having recalled a memory channel, you can temporarily change the modulation mode, the filter bandwidth, or other settings. You also can change temporarily the frequency of a memory channel using the tuning control if Menu **B**, No. 57 is turned on. Refer to Menu Set-up on page 47. The factory default is off. When you later recall that memory channel, you will find the original settings unchanged.

MEMORY CONTENTS CONFIRMATION

The contents of a memory channel can be confirmed without changing the receive frequency. Follow this procedure:

- 1 Press the **M.IN** button to enter the Memory Scroll mode. The **M.SCR** indicator appears. The receiver continues to operate. Only the display changes.

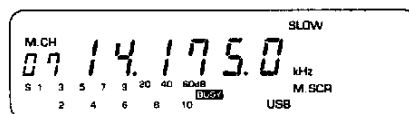

- 2 Select the memory channel to be confirmed using the **UP** or **DOWN** button.

Example: Recall memory channel 8, containing 21.235 MHz (split).

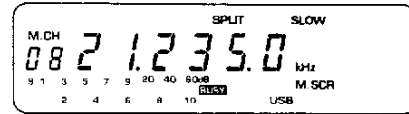

- 3 To clear **M.SCR** and return to the previous mode, press the **CLR** button.

MEMORY TRANSFER

Transfer memory channel contents to the VFO with this procedure:

- 1 Press the **M/V** button to change from VFO to Memory Channel mode. The last memory channel number selected appears.

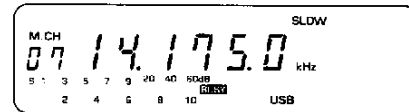

- 2 Select a memory channel using the **UP** or **DOWN** button.

Example: Recall memory channel 8, containing 21.235 MHz (split).

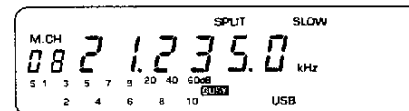

- 3 Press the **M > V** button. The displayed data is transferred to the VFO, and the **VFO** mode is restored. It is now possible to change the frequency or any other setting.

*Note: Pressing the **M > V** button clears present VFO data, but the recalled memory channel data remains unchanged.*

4 MEMORY FEATURES

The following diagram shows how transmit and receive frequencies are transferred:

VFO Status BEFORE Pressing M>V Button				VFO Status AFTER Pressing M>V Button		
	A	VFO B		Type of Memory Channel	A	VFO B
RX	●		→	Simplex Channel or Channel 99	RX	●
TX	●				TX	●
RX		●	→	Simplex Channel or Channel 99	RX	●
TX		●			TX	●
RX	●		→	Split Channel	RX	●
TX		●			TX	●
RX		●	→	Split Channel	RX	●
TX		●			TX	●
RX	●		→	Simplex Channel or Channel 99	RX	●
TX	●				TX	●
RX		●	→	Simplex Channel or Channel 99	RX	●
TX	●				TX	●
RX		●	→	Split Channel	RX	●
TX	●				TX	●

MEMORY CHANNEL CLEAR

Clear a memory channel with this procedure:

- 1 Press the M/V button to change from VFO to Memory Channel mode. The last memory channel number selected appears.

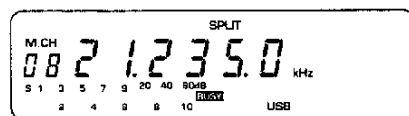

- 2 Select a memory channel using the UP or DOWN button.
Example: Select memory channel 7, containing 14.175 MHz.

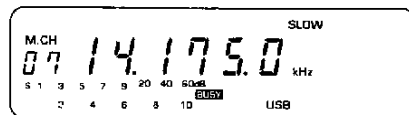

- 3 Press the CLR button for approximately two seconds. The displayed frequency is cleared and the memory channel is erased.

- 4 To return to the VFO mode, press the M/V button.

4 • MEMORY FEATURES

MEMORY CHANNEL PROTECT

There are two ways to protect memory channels from being cleared accidentally:

- Memory Protect 1: Write/delete inhibit
- Memory Protect 2: Overwrite/delete inhibit

MEMORY PROTECT 1 (WRITE/DELETE INHIBIT)

- 1 Press the **F.LOCK** button for more than two seconds to enter the Menu Set-up mode.

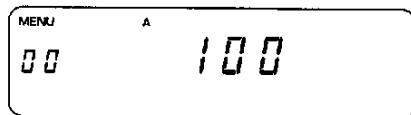

- 2 Press the **A/B** button to select Menu B.

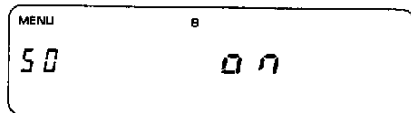

- 3 Use the tuning control to select Menu No. 59.

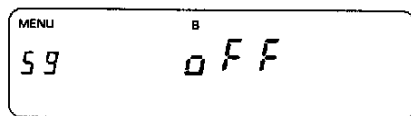

- 4 Select **ON** using the **UP** or **DOWN** button.

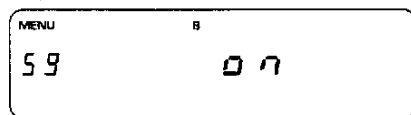

- 5 Press the **CLR** or **F.LOCK** button to exit the Menu Set-up mode.
- 6 If you attempt to store data in any memory channel, the Morse code "CHECK" alarm will sound to remind you that memory protect is on. In addition, you cannot clear any memory channel using the **CLR** button.

MEMORY PROTECT 2 (OVERWRITE/DELETE INHIBIT)

- 1 Press the **F.LOCK** button for more than two seconds to enter the Menu Set-up mode.

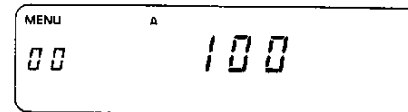

- 2 Press the **A/B** button to select Menu B.

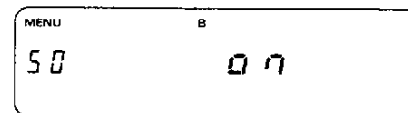

- 3 Use the tuning control to select Menu No. 59. Select **OFF** using the **UP** or **DOWN** button.

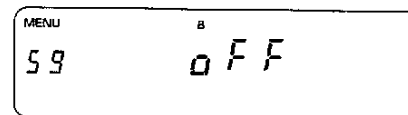

- 4 Use the tuning control to select Menu No. 60. Select **ON** using the **UP** or **DOWN** button.

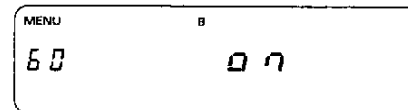

- 5 Press the **CLR** or **F.LOCK** button to exit the Menu Set-up mode.
- 6 You can store data in an empty channel now, but if you attempt to overwrite data in an occupied memory channel, the Morse code "CHECK" alarm will sound to remind you that memory protect is on.

In addition, you cannot clear any memory channel using the **CLR** button.

QUICK MEMORY CHANNEL SELECT SELECTING A CHANNEL CONTAINING DATA

Select from occupied memory channels while skipping the empty channels with this procedure:

- 1 Press the **M/V** button to change from **VFO** to Memory Channel mode. The last memory channel number selected appears.

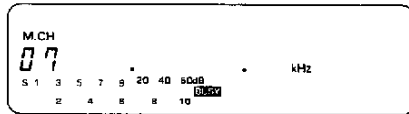

- 2 Press the **MHz** button. The 1 MHz indicator appears.

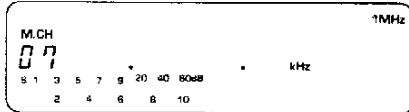

- 3 Press the **UP** or **DOWN** button to select from the occupied memory channels.
- 4 To return to the **VFO** mode, press the **M/V** button, or press the **M > V** button to transfer the memory data to the VFO.

Note: If all memories are empty (no data stored), pressing the UP or DOWN button will cause the Morse code "CHECK" alarm to sound.

SELECTING AN EMPTY CHANNEL

Select from the empty channels with this procedure:

- 1 Press the **M.IN** button to enter the Memory Scroll mode. The **M.SCR** indicator appears. The receiver continues to operate. Only the display changes.

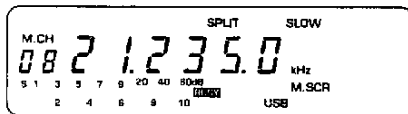

- 2 Press the **MHz** button. The 1 MHz indicator appears.

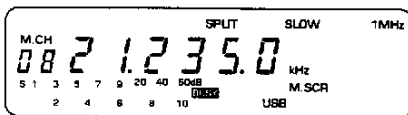

- 3 Press the **UP** or **DOWN** button to switch among the empty memory channels.

5 SCAN

MEMORY SCAN

The transceiver will scan all memory channels containing data (All-channel Scan) or only the selected channel group (Group Scan). For the selection method, refer to Menu Set-up (Menu A, No. 13). The factory default is Group Scan.

GROUP SCAN

There are 100 memory channels, divided into groups of 10 channels (00 to 09, 10 to 19, ..., 90 to 99). The transceiver scans only memory channels which belong to the specified group and contain data.

- 1 Press the **M/V** button to change from **VFO** to Memory Channel mode. The last memory channel number selected appears.

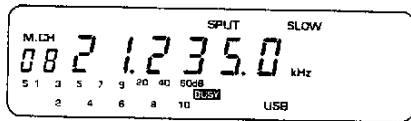

- 2 Use the **UP** or **DOWN** button to select any memory channel belonging to the desired group. Adjust the SQL control while no signal is present.

Example: To scan channels 10 to 19, select memory 12, for instance.

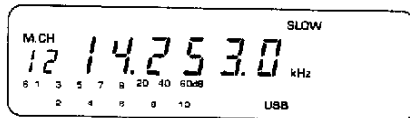

- 3 Press the **SCAN** button. The transceiver scans the specified group.
- 4 To switch the channel group during scan, use the microphone **UP** and **DWN** buttons.
- 5 To stop scan, press the **SCAN** or **CLR** button, or press the microphone **PTT** button momentarily.
- 6 To restore the **VFO** mode, stop scan and then press the **M/V** button, or press the **M > V** button to transfer the memory data to the VFO.

ALL-CHANNEL SCAN

Scan all memory channels containing frequency data with this procedure:

- 1 Press the **M/V** button to change from **VFO** to Memory Channel mode. The last memory channel number selected appears.

Adjust the SQL control while no signal is present. Remember, Menu A, No.13 must be **ON**.

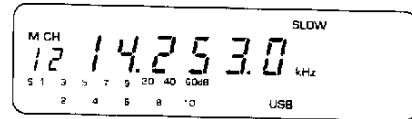

- 2 Press the **SCAN** button. The **SCAN** indicator appears, and all occupied memory channels are scanned.

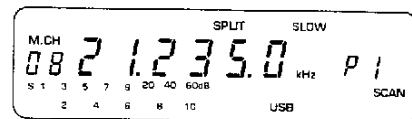

- 3 The **UP** and **DOWN** buttons on the transceiver and microphone operate during scan.
- 4 To stop scan, press the **SCAN** or **CLR** button. Or, momentarily press the microphone **PTT** button.
- 5 To restore the **VFO** mode, stop scan and press the **M/V** button, or press the **M > V** button to transfer the memory data to the VFO.

Note: If no data is stored in the memories, or you have locked-out all memories, pressing the SCAN key will sound the Morse code "CHECK" reminder.

CONFIRMING START AND END FREQUENCIES

Confirm the start and end frequencies stored in memory channel 99 with this procedure:

- 1 Press the **M/V** button to change from **VFO** to Memory Channel mode. The last memory channel number selected appears.

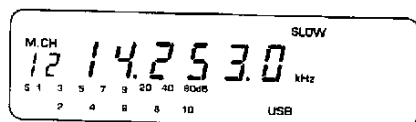

- 2 Select memory channel 99 using the **UP** or **DOWN** button.

Example: 7.030 MHz is stored in memory channel 99.

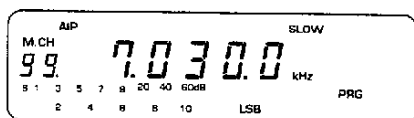

- 3 Press the **F.LOCK** button. The **F.LOCK** indicator appears.

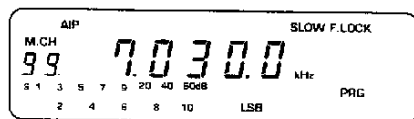

- 4 Display the start frequency by pressing the **DOWN** button, and the end frequency by pressing the **UP** button.

Switch the **F.LOCK** button off to change the operating frequency using the tuning control.

- 5 To return to the **VFO** mode, switch off **F. LOCK** and press the **M/V** button, or press the **M > V** button to transfer the memory data to the **VFO**.

MEMORY CHANNEL LOCK-OUT

Select memory channels to be skipped during memory scan with this procedure:

- 1 Press the **M/V** button to change from **VFO** to Memory Channel mode. The last memory channel number selected appears.

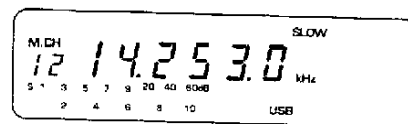

- 2 Use the **UP** or **DOWN** button to select the memory channel to be skipped.

Example: Recall memory channel 14, containing 14.048 MHz.

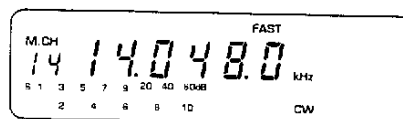

- 3 Momentarily press the **CLR** button. A dot appears beside the memory channel number to indicate the channel has been locked-out.

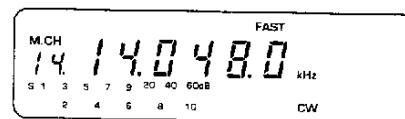

- 4 Momentarily press the **CLR** button again, and lock-out for that memory channel is canceled and the dot is cleared.
- 5 In order to restore the **VFO** mode, press the **M/V** button, or press the **M > V** button to transfer the memory data to the **VFO**.

Note:

- 1 If you hold the **CLR** button for more than 2 seconds, the currently selected channel contents will be erased.
- 2 If you attempt to scan the memories, and have locked-out all memory channels containing data, a Morse code "CHECK" alarm will sound.
- 3 Even when Memory Protect 1 or 2 is on, you can lock-out or unlock memory channels.
- 4 Memory channel 99 is locked-out automatically after the first use of program scan.

5 SCAN

PROGRAM SCAN

SCAN

Press the **SCAN** button while in the **VFO** mode, and the transceiver scans upwards from the current operating frequency. Hold the microphone **DWN** button to scan downwards. Releasing the microphone **DWN** button causes the scan to resume upwards.

If no data is stored in channel 99, the following data will be automatically stored in that channel when you press the **SCAN** button:

Start frequency: 30.0 kHz

End frequency: 29.999.9 MHz

Scan will ascend from the current operating frequency and scan the above range.

If the scan range stored in channel 99 does not include the current operating frequency, scan will jump to the start frequency and begin to scan.

A If channel 99 contains no data:

- 1 Press the **SCAN** button.
Scan ascends from the currently displayed frequency. The scan range will be 30 kHz to 29.999.9 MHz.
- 2 Modulation settings and frequency can be changed during scan. To change frequency, use the tuning control, or the microphone **UP** and **DWN** buttons.
- 3 To stop scan, press the **SCAN** or **CLR** button, or press the microphone **PTT** button momentarily.

B If channel 99 contains data:

Example: 14.000 MHz (start) and 14.010 MHz (end) have been stored in channel 99.

Press the **SCAN** button, and scan will cycle in the stored frequency range.

CONFIRMING START AND END FREQUENCIES

Start and end frequencies stored in memory channel 99 may be confirmed using this procedure:

- 1 Press the **M/V** button to change from **VFO** to Memory Channel mode. The last memory channel number selected appears.

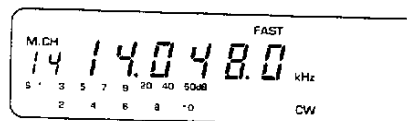

- 2 Select memory channel 99 using the **UP** or **DOWN** button.

Example: 7.030 MHz is stored in memory channel 99.

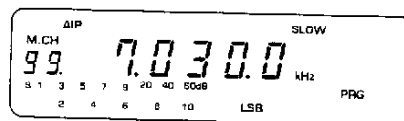

- 3 Press the **F.LOCK** button, and the **F.LOCK** indicator appears.

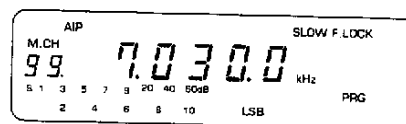

- 4 Display the start frequency by pressing the **DOWN** button, and the end frequency by pressing the **UP** button.
- 5 Switch the **F.LOCK** button off to change the operating frequency using the tuning control.
- 6 To return to the **VFO** mode, switch the **F.LOCK** off and press the **M/V** button, or press the **M > V** button to transfer the memory data to the **VFO**.

SCAN HOLD

Turn the tuning control during program scan with Scan Hold on, and scan will stop on the current frequency, and then resume a short time later. Turn off the Busy-Frequency Stop function for program scan (Menu **A**, No. 9) to use Scan Hold.

To enable this function, refer to Menu Set-up (Menu **B**, No. 58) on page 47.

Note: If either the AT-50 or AT-300 antenna tuner is connected to the transceiver, pressing the **AT TUNE** button while scanning halts scan. With no tuner connected, scan is not affected.

BUSY-FREQUENCY STOP

When a signal is received during memory or program scan, the transceiver automatically stops scan and remains on that frequency for either a short time (Time Operated mode), or remains until the signal drops (Carrier Operated mode). The Squelch must be adjusted to the noise threshold point when there is no signal.

In the Time Operated mode, scan stops on a busy frequency for approximately six seconds, and then resumes.

In the Carrier Operated mode, scan stops on a busy frequency while a signal is present, and resumes approximately two seconds after the signal drops.

Select the stop mode using the Menu Set-up function. Menu **A**, No. 10 is for program scan, and Menu **A**, No. 12 is for memory scan (refer to page 46.) Time Operated mode is the factory default.

Note: For scan to stop, the Squelch control must be set to just beyond the threshold (where the background noise just disappears when no signal is present).

The Busy-Frequency Stop function can be turned on or off. Refer to Menu Set-up on page 46. Menu **A**, No. 09 is for program scan, and Menu **A**, No. 11 is for memory scan.

SCAN SPEED CHANGE

The scan speed can be varied from the default fastest rate using the RIT control. A weight value appears on the display right during scan that acts as a speed reference number. Turning the RIT control clockwise decreases the scan speed, and counterclockwise increases the speed.

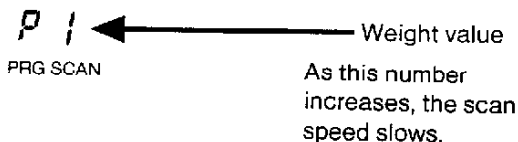

When using the 500 Hz filter or listening for particularly weak signals, use a slower scan speed to ensure scan stops on all signals.

The scan step size, and therefore the scan speed, varies according to whether Busy-Frequency Stop is on or off, and which modulation mode is selected as follows:

Busy-Frequency Stop OFF		Busy-Frequency Stop ON		
SSB/CW	FM/AM	SSB/CW	FM	AM
10 Hz	100 Hz	1 kHz	10 kHz	*5 kHz

* Except in the Broadcast Band: 9 kHz steps when 9 kHz is selected via Menu **B**, No. 61. Refer to Menu Set-up on page 47.

Turning the RIT control counterclockwise decreases the weight value (faster scan speed) whereas turning it clockwise increases the weight value (slower scan speed). Any value selected remains in effect until you adjust the control again, or until you reset the transceiver using the **A=B** key.

Remember to center the RIT control once finished scanning to avoid confusion later when the RIT is used.

6 OTHER USEFUL FEATURES

CONTROLS

FREQUENCY STEP CHANGE

A Tuning control

The frequency step automatically varies depending on how fast the tuning control is turned. As the control is turned more quickly, the frequency step increases through the range of 5 Hz to 200 Hz. In the FM mode, the range is from 50 Hz to 2 kHz.

B MHz button

Press this button to change the frequency in 1 MHz steps using the **UP** or **DOWN** button. The frequency step setting can be changed to 500 kHz from 1 MHz. Refer to Menu Set-up for Menu **B**, No. 62 on page 47. 1000 kHz is the default.

AMATEUR BAND SWITCHING

When the MHz indicator is off, you can switch between consecutive amateur bands using the **UP** and **DOWN** buttons. The transceiver switches to the next band in sequence as shown below each time one of the buttons is pressed.

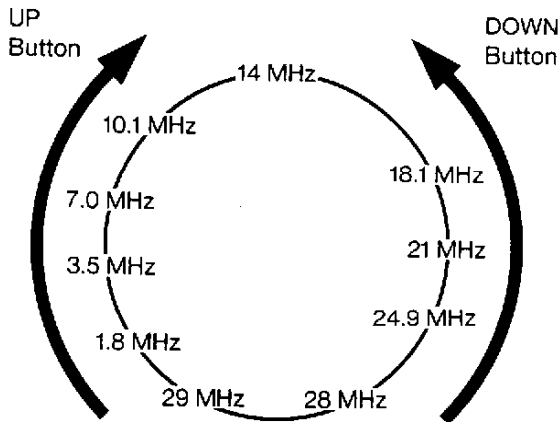

RIT OPERATION

When the frequency of your contact shifts, you can vary your receive frequency within ± 1.1 kHz, without changing your transmit frequency. Use this procedure:

- 1 Press the **RIT** button.
The RIT indicator and the shift frequency value will appear on the display right.



- 2 Adjust the **RIT** control to correct your receive frequency.
As the control is adjusted, the new frequency shift updates both the RIT shift display and the transceiver frequency display in 100 Hz steps.

Although 100 Hz steps are displayed, the control actually shifts the receiver in 10 Hz steps.

- 3 To switch off the **RIT**, press the **RIT** button.
The combination of ± 1.1 kHz and 10 Hz steps have been factory set, and may be changed to a combination of ± 2.2 kHz and 20 Hz steps. Refer to Menu Set-up (Menu **B**, No. 63) on page 47.

It's a good habit to turn off RIT after a contact is finished. This returns the receive frequency to the transmit frequency. It ensures you don't listen by mistake on a different frequency from your transmit frequency on the next contact. When in the Memory Channel mode, RIT only functions with a memory channel containing stored data. RIT does not function with an empty memory channel.

If extremely precise transmit and receive frequency readout is required, the RIT display can display the 10 and 1 Hz digits of your frequency. Use Menu **B**, No. 67 through 70 to assign Special Function No. 85 to one of the microphone PF keys. Once assigned, pressing this key causes the 10 and 1 Hz digits for the transceiver frequency to appear on the display right until the PF key is released. This display has priority over the RIT display but there is no other effect on RIT. Refer to Menu Set-up on page 47 and Special Functions on page 50.

Although the minimum step size is 5 Hz, exact frequencies to the nearest Hz are tunable by taking advantage of fuzzy logic (refer to "Tuning control" on page 16). If your desired frequency is not a multiple of the current 5 Hz steps, turn the tuning control slightly but quickly about the desired frequency. Fuzzy logic temporarily alters the step size due to the rapid tuning action. Now slowly tune the desired frequency. One or two attempts may be necessary to select the correct multiple. You can select any frequency to the nearest Hz by using this technique.

Note: When tuning very slowly, a counting error of ± 1 step may occasionally be observed. This is not a malfunction.

6 OTHER USEFUL FEATURES

DUAL DIGITAL VFOs

A VFO and **VFO B** function independently, so that different frequencies can be set in each VFO. Use these buttons to operate the VFOs:

A/B button

Press to toggle between **VFO A** and **B**.

- 1 Assume that you are presently on **A VFO** and have selected 7.000 MHz.

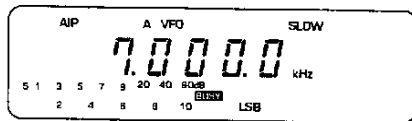

- 2 Press the **A/B** button.
- 3 **VFO B** is selected, and another frequency (for example the factory default, 14.000 MHz) is displayed.

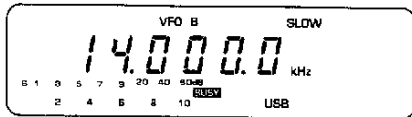

- 4 Press the **A/B** button to toggle back to the **A VFO** on 7.000 MHz.

A=B button

Press this button to transfer the frequency and modulation mode of the active VFO to the inactive VFO.

- 1 Assume that you are presently on **A VFO** and have selected 7.000 MHz.

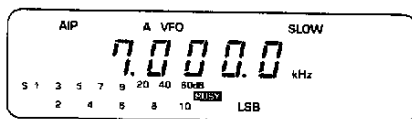

- 2 Press the **A/B** button.
- 3 **VFO B** is selected, and another frequency (for example the factory default, 14.000 MHz) is displayed.

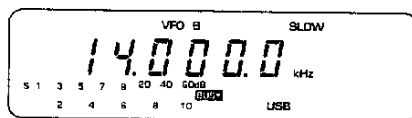

- 4 Press the **A=B** button.

- 5 Press the **A/B** button again. You will return to **A VFO** and find that the frequency and modulation mode have been replaced by the **VFO B** values.

AUTOMATIC POWER OFF (APO)

If the buttons or controls listed in the table are not operated for approximately a 180 minute fixed interval, the transceiver will automatically switch off. One minute before this time is reached, the APO indicator will appear on the display, and the transceiver will "beep" continuously for one minute. These beeps do not stop until after you operate one of the buttons or controls in the table below. If none are operated within the one minute period, the transceiver simply switches off. The setting may be changed so that Automatic Power Off will not activate. Refer to Menu Set-up (Menu **B**, No. 64) on page 47. The default is OFF.

Buttons	AT TUNE, AIP/ATT, NB, F.LOCK, DOWN, UP, MHz, A/B, SPLIT, A=B, SSB/CW, FM/AM, RIT, SCAN, CLR, M.IN, M>V, M/V
Controls	TUNING, RIT, IF, SHIFT
Microphone	PTT, UP, DOWN, PF1, PF2, PF3, PF4

Note:

- 1 With APO on, the timer stops counting during scan, AT tuning, or in the Menu Set-up mode.
- 2 The 180 minute interval is not adjustable.
- 3 Pressing a button or turning a control restarts the 180 minute counter immediately, even during the final one minute warning period before power switches off.

6 OTHER USEFUL FEATURES

INTERFERENCE AND NOISE ELIMINATION

IF SHIFT

IF Shift functions only in the **SSB** or **CW** modes. This allows you to shift the IF filter pass band without changing the receive frequency.

When the IF pass band is shifted, as shown in the diagram, it is possible to reduce or completely eliminate adjacent frequency interference.

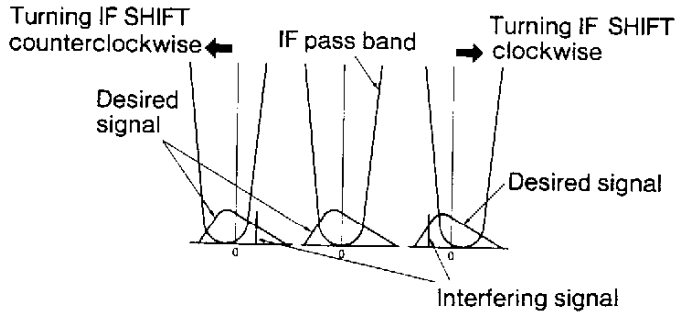

Adjust the **IF SHIFT** control clockwise to eliminate an interfering signal lower than your receive frequency. This attenuates interference lower in frequency.

Adjust the **IF SHIFT** control counterclockwise to eliminate an interfering signal higher than your receive frequency. This attenuates interference higher in frequency.

IF FILTER

In the **SSB**, **CW**, or **AM** mode, you can use the narrow filter by changing the menu setting. Refer to Menu Set-up (Menu **A**, No. 03) on page 46.

For **SSB** and **CW**, you can change from the 2.4 kHz standard filter to the 0.5 kHz (optional) filter. You must first install the optional 0.5 kHz filter.

For **AM**, you can change from the standard 6 kHz AM filter to the built-in 2.4 kHz filter.

Note:

- 1 The **-N** indicator appears when the 0.5 kHz filter is selected for **SSB** or **CW**, or when the 2.4 kHz filter is selected for **AM**.
- 2 There is no filter selection for **FM**.

NOISE BLANKER

Switch the **NB** button on if there is interference from pulse noise, such as that caused by automobile ignitions. The **NB** indicator shows the noise blanker is on.

The noise blanker suppresses pulse noise and makes receiving easier.

Switch the noise blanker off by pressing the **NB** button again.

Note: When receiving a strong signal with the **NB** on, receiver audio may be distorted. The Blanker is being "pumped" by the strong signal. To eliminate this distortion, switch off the **NB**.

AUDIO AND SOUND FEATURES

"BEEP" TONE

The transceiver "beeps" to confirm that a button is pressed. The volume of the beep is adjustable with a variable resistor inside the transceiver. Refer to "Adjustments" on page 54. If desired, it is possible to turn off the function. Refer to Menu Set-up (Menu **B**, No. 50) on page 47.

MODE CONFIRMATION TONE OUTPUT (MORSE CODE or BEEP)

Pressing a modulation mode button causes the first character of the mode to sound in Morse code. This can be changed so that a beep will sound instead. Refer to Menu Set-up (Menu **B**, No. 51) on page 47.

Mode	Morse Code Output
LSB (-N)	• — • • (L)
USB(-N)	• • — (U)
CW(-N)	— • — • (C)
CW(R)	— • — • • — • (CR)
AM(-N)	• — (A)
FM	• • — • (F)

MORSE CODE ALARM OUTPUT

If you encounter any of the situations described in the table, you will hear the Morse code "CHECK" alarm. This can be changed so that a beep will sound instead. Refer to Menu Set-up (Menu B, No. 52) on page 47.

Situation	Morse Code Output
1 Scan button pressed when memory scan cannot function.	"CHECK"
2 No data has been stored in the specified memory channel while using QUICK MEMORY CHANNEL SELECT.	
3 All selected memory channels have been locked out.	— • — • • • • • •
4 Data storage attempted with Memory Protect on.	— • — • — • —
5 AT TUNE button pressed without the automatic antenna tuner connected.	

CARRIER POINT SHIFT

The carrier point for SSB mode can be shifted in order to optimize the sound of your transmit signal. Shifting the carrier point in a positive direction cuts off lower frequencies. Shifting the point in a negative direction cuts off higher frequencies. Minimize use of this adjustment as excessive change affects transceiver carrier suppression.

Adjust the modulation carrier point in 10 Hz steps using the Menu Set-up. Refer to the Menu Set-up (Menu B, No. 71 and No. 72) on page 47.

- 1 Menu No. 71: LSB mode correction
Range: -100 Hz to +200 Hz
- 2 Menu No. 72: USB mode correction
Range: -100 Hz to +200 Hz

6 OTHER USEFUL FEATURES

MICROPROCESSOR RESET

INITIAL SETTINGS

Shown below are the factory defaults:

	Frequency (MHz)	Modulation Mode	AGC
VFO A	14.000.0	USB	SLOW
VFO B	14.000.0	USB	SLOW
Memory channel (00 to 99)		—	—

RESET

The microprocessor can be reset two ways.

A Partial Reset to restore normal operation:

Do a Partial Reset if a button or the tuning control does not function normally.

Hold the **A/B** button and switch the power on. These settings will be reset:

Parameter	After Partial Reset
A VFO, VFO B	14.000.0 MHz, USB
Band memories	Factory defaults
Filters	Factory defaults
AGC	Factory default
Operation mode	VFO mode

Note:

- 1 A partial reset using the A/B button does not erase any data stored in memory channels.
- 2 A full reset using the A=B button erases all user entered data in the memory channels.

B Full Reset to restore the factory defaults:

Hold the **A=B** key and switch the power on. Reset will occur as follows:

Parameter	After Full Reset
Memory channels	Empty (no data)
Band memories	Factory defaults
Menu settings	Factory defaults (pages 46 and 47)
Memory Protect 1 & 2	Off (page 47)

Note:

- 1 Full reset will return all memory channels and menu settings to their factory defaults even if Memory Protect 1 or 2 is on.
- 2 Neither partial reset nor full reset can be assigned to the microphone PF keys.

7 MENU SET-UP

MENU A SETTING

Menu A contains those items listed in the table below. These are the more frequently changed functions. Follow this procedure to change the settings:

- 1 Press the **F.LOCK** button for more than two seconds to enter the Menu Set-up mode.

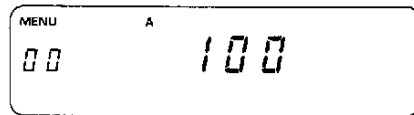

- 2 If the B indicator appears, press the **A/B** button to display the A indicator.

- 3 The menu number appears at the left of the display and the current setting appears at the center.
- 4 Select the menu number using the tuning control.
- 5 Select the setting using the **UP** or **DOWN** button.
- 6 After you have changed a setting, press the **CLR** or **F.LOCK** button to exit the Menu Set-up mode.

Menu No.	Description	Selections	Default	Reference page
00	RF output power switches through three levels (100, 50, and 10 W).	100/50/10	100	20
01	Display brightness switches through five levels.	OFF/d4/d3/d2/d1	d2	-
02	AGC mode switches between slow(S) or fast(F). (SSB , CW and AM only. No selection in FM .)	S/F	S (CW:F)	19, 27
03	IF filter select. (SSB , CW , and AM only. No selection in FM .)	0.5/2.4/6.0kHz	2.4kHz (AM:6.0kHz)	20, 22, 43
04	SSB/CW mode switches between two-steps (SSB) and three-steps (ULC).	SSB/ULC	SSB	17
05	CW keying delay switches between FULL (full break-in), or a value in milliseconds.	FULL/100/200/300/ 400/600/800/1000/ 1400/1800 ms	600	24
06	CW offset switches through the range of 400 to 1000 Hz in 50 Hz steps. Sidetone is fixed at 800 Hz.	400—1000	800	23
07	CW reverse function.	ON/OFF	OFF	23
08	Tuning control disable.	ON/OFF	OFF	-
09	Busy-Frequency Stop for program scan.	ON/OFF	ON	40
10	Busy-Frequency Stop for program scan switches between Time Operated (0) and Carrier Operated (1).	0/1	0	40
11	Busy-Frequency Stop for memory scan.	ON/OFF	ON	40
12	Busy-Frequency Stop for memory scan switches between Time Operated(0) and Carrier Operated(1).	0/1	0	40
13	Memory channel scan switches between all memory channels(ON)or only the desired channel group(OFF).	ON/OFF	OFF	37
14	RF meter sensitivity switches between X4 scale (ON) or normal(OFF). Only available with 10 W selected.	ON/OFF	OFF	20
15	Subaudible tone frequency. OFF may not allow repeater access.	ON/OFF	ON	20, 29
16	Frequency step size from microphone (SSB and CW modes only) switches through five step sizes.	10/100/1k/5k/10kHz	10kHz	49
17	Frequency step size from microphone (FM and AM modes only) switches through five step sizes.	10/100/1k/5k/10kHz	10kHz	49

7 MENU SET-UP

MENU B SETTING

Menu B contains those items listed in the table below. These are the less frequently changed functions. Use the following procedure to change the settings:

- 1 Press the **F.LOCK** button for more than two seconds to enter the Menu Set-up mode.

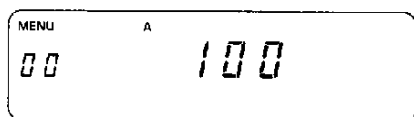

- 2 If the A indicator appears, press the **A/B** button to display the B indicator.

- 3 The menu number appears at the left of the display and the current setting appears at the center.
- 4 Select the menu number using the tuning control.
- 5 Select the setting using the **UP** or **DOWN** button.
- 6 After you have changed a setting, press the **CLR** or **F.LOCK** button to exit the Menu Set-up mode.

Menu No.	Description	Selection	Default	Reference page
50	Beep sounds when any button is pressed.	ON/OFF	ON	43, 54
51	Modulation mode select switches between Morse(ON) or beep(OFF).	ON/OFF	ON	43
52	Alarm output switches between Morse(ON) or beep(OFF).	ON/OFF	ON	44
53	Tone frequency select for repeater access (39 tones)	67.0~250.3Hz, 1750Hz	88.5Hz	20, 29
54	Tone frequency type for repeater access (b: burst, c: continuous)	b/c	c	20, 29
55	Peak Meter Hold.	ON/OFF	ON	20
56	Memory channel automatic increment after data is stored.	ON/OFF	OFF	—
57	Tuning control able to change frequency in Memory Channel mode.	ON/OFF	OFF	—
58	Program Scan Hold.	ON/OFF	OFF	39
59	Memory Protect 1. ON prevents writing to or clearing any memory channel.	ON/OFF	OFF	14, 35
60	Memory Protect 2. ON prevents overwriting or clearing memory channels containing data.	ON/OFF	OFF	14, 35
61	AM Broadcast band(522 to 1620 kHz) frequency step size switches between two sizes in AM only. (U.S.A./Canada: 522 to 1710 kHz)	9/10kHz	9kHz*	49
62	1 MHz button frequency step size switches between 1 MHz and 500 kHz.	1000/500kHz	1000kHz	15, 36, 41
63	RIT maximum frequency shift switches between two values.	1.1/2.2kHz	1.1kHz	41
64	Automatic Power Off.	ON/OFF	OFF	42
65	PTT switch disable. ON prevents PTT from functioning.	ON/OFF	OFF	49
66	Microphone gain switches between high(H) or low(L).	H/L	L	22, 26
67	Microphone PF1 key assignment.	00~99	83(Menu A)	49, 50
68	Microphone PF2 key assignment.	00~99	00(Power Select)	49, 50
69	Microphone PF3 key assignment.	00~99	36(TF-SET)	49, 50
70	Microphone PF4 key assignment.	00~99	82(Monitor)	49, 50
71	LSB transmit carrier point shift. (10 Hz steps)	-100~+200	000	44
72	USB transmit carrier point shift. (10 Hz steps)	-100~+200	000	44

* U.S.A./Canada: 10 kHz(Use Menu A, No.17 to vary step size)

8 OPERATION USING ACCESSORIES

LINEAR AMPLIFIER

CONNECTION TO THE TRANSCEIVER

Below is a summary of how to connect your transceiver to the optional TL-922 Linear Amplifier.

- 1 Switch off both the transceiver and the amplifier. Disconnect both units from their power sources.
- 2 Install two commercially available audio cables equipped with audio pin (phono) plugs between the transceiver and the amplifier.
- 3 Install a coaxial RF cable (e.g. RG-8A/U) between the two units.
- 4 Connect your antenna system RF feed line to the RF output jack on the amplifier.
- 5 After checking all connections, reconnect the transceiver and amplifier to their power sources.

Consult the TL-922 Operating Manual to review the correct operating procedure for the amplifier.

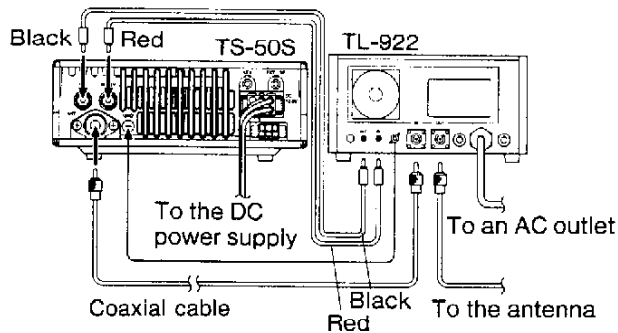

AUTOMATIC ANTENNA TUNER

The transceiver can be operated with either an optional AT-50 or AT-300 automatic antenna tuner. These tuners are useful for matching antennas that have an SWR greater than 1.5:1. Use the RF meter in the transceiver to monitor forward power while tuning with either the AT-50 or AT-300.

Remember to switch off the transceiver and its input power before connecting the antenna tuner. Once the tuner is connected correctly, switch on the transceiver power source. The transceiver checks if the tuner is connected when the transceiver is switched on.

Note: For connection with the AT-50 or AT-300, refer to the automatic antenna tuner instruction manual.

CONNECTION TO THE TRANSCEIVER

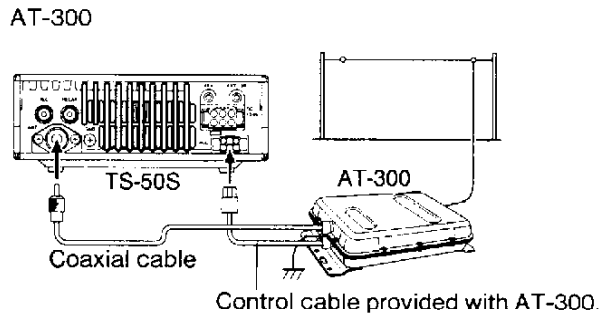
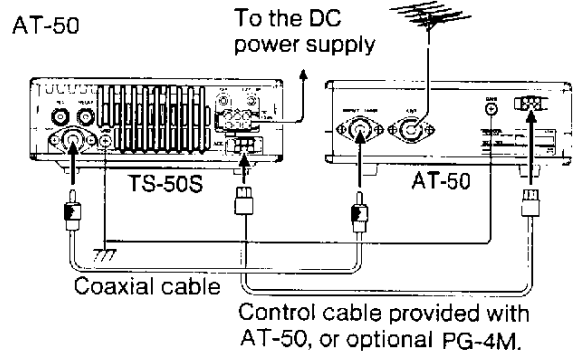

Note: Do not use the AT-300 for mobile applications.

OPERATION

- 1 Select the transmit frequency.
- 2 Press the **AT TUNE** button. The **CW** mode is set, **ON AIR** and **AT TUNE** light, and tuning starts.

Note:

- 1 When using the AT-50, the AT display indicator appears whenever the tuner is set to AUTO; the indicator clears when THRU is selected. Also, powering the TS-50S automatically selects the AUTO position.
- 2 Transmitter output power is 10 W during tuning.

8 OPERATION USING ACCESSORIES

- 3 When tuning is finished, **AT TUNE** and **ON AIR** go off, and the previous modulation mode is restored.

If tuning is not finished within 30 seconds, an alarm beep sounds. Press the **AT TUNE** button to end the tuning operation.

Note: If an alarm sounds, the antenna system may have failed. Check the antenna system first.

- 4 Confirm that the antenna system functions normally, and press the **AT TUNE** button again.

Note:

- 1 Pressing the **AT TUNE** button for more than 1.5 seconds will disconnect the antenna tuner. To restore the **AUTO** mode, press the **AT TUNE** button. The tuner first retunes, and then the **AUTO** mode is restored. You can change **AUTO** to **THRU**, but not **THRU** to **AUTO** outside the amateur bands. Return to the amateur bands, and then press the **AT TUNE** button.
- 2 The antenna tuner functions only when the transceiver can transmit on the selected frequency.
- 3 After tuning up once with the **AT-50**, you need not press the **AT TUNE** button each time you turn the transceiver on. The tuner settings used last will be reused.
- 4 If either the **AT-50** or **AT-300** antenna tuner is connected to the transceiver, pressing the **AT TUNE** button while scanning halts scan. With no tuner connected, scan is not affected.

MICROPHONE

Use the following buttons and keys on the MC-47 microphone to control the transceiver:

UP AND DWN BUTTONS

Press the **UP** or **DWN** button in the **VFO** mode to raise or lower the operating frequency. Press either button in the Memory Channel mode to select any channel. In the Menu Set-up mode, use the buttons to switch through all selections of the displayed menu item. Hold down either button to continuously change the frequency, memory channel or menu item selection.

The 100 memory channels are divided into ten groups of ten channels each. While scanning channels using Group Scan in Memory Channel mode, pressing either the microphone **UP** or **DWN** button shifts scan to the adjacent channel group. Group scan resumes automatically within the new group.

The transceiver frequency step can be changed from the microphone. Refer to Menu Set-up (Menu **A**, No. 16 and No. 17). 10 kHz is the default. It is also possible to switch between 9 kHz and 10 kHz tuning steps for the AM Broadcast band when in AM mode.

If 10 kHz steps are selected via Menu **B**, No. 61 then additional tuning flexibility in the Broadcast Band is available by using Menu **A**, No. 17 to reduce the step size further. Refer to Menu Set-up on page 46.

PTT BUTTON

Hold down the **PTT** button to transmit. Press this button once while scanning to stop scan. Disable the **PTT** button by changing Menu **B**, No. 65. Refer to Menu Set-up on page 47.

PROGRAMMABLE FUNCTION KEYS (MICROPHONE PF1 TO PF4 KEYS)

Use the **PF** keys for Menu Set-up changes, and for button and special functions listed on page 50.

To assign functions to PF keys, use the following information:

Menu B No.	Programmable Key No.	Factory Defaults
67	PF1	Menu A mode select (Menu No. 83)
68	PF2	Transmit power level switch (Menu No. 00)
69	PF3	TF-SET (Menu No. 36)
70	PF4	Monitor (Menu No. 82)

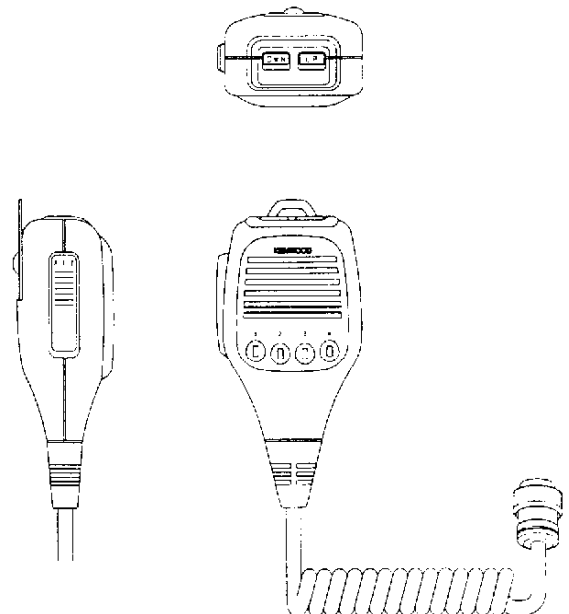

8 OPERATION USING ACCESSORIES

■ Assigning Functions to PF Keys

- 1 Hold the **F.LOCK** button for more than two seconds to enter the Menu Set-up mode.
- 2 Press the **A/B** button to select Menu **B**.
- 3 Select Menu Nos. 67 through 70 with the tuning control.
- 4 Select the desired function using the **UP** or **DOWN** button.
- 5 Press the **CLR** or **F.LOCK** button to exit Menu Set-up mode.
- 6 Press the microphone PF keys to select the assigned functions.

Button Functions

Menu No.	Front Panel Functions
20	AT TUNE
21	AIP
22	ATT
23	NB
24	F.LOCK
25	UP
26	DOWN
27	MHz
28	RIT
29	SCAN
30	CLR
31	M.IN
32	M>V
33	M/V
34	A/B
35	SPLIT
36	TF-SET
37	A=B
38	SSB/CW
39	FM/AM

Special Functions

Menu No.	Special Function
80	AF MUTE
81	AF ATT
82	MONITOR
83	Menu A operation start
84	Menu B operation start
85	RIT displays 10 Hz and 1 Hz frequency digits while the PF key is pressed.
99	OFF

Note:

- 1 Assigning the AIP or ATT function to a PF key removes that function from the front panel button. If both functions are assigned to separate PF keys, the front panel button works as described on page 12.
- 2 Assigning Menu No. 99 to a PF key disables the key.

9 MAINTENANCE AND ADJUSTMENTS

GENERAL INFORMATION

Your transceiver has been factory aligned and tested to specification before shipment. Under normal circumstances, the transceiver will operate in accordance with these operating instructions. All adjustable trimmers, coils and resistors in the transceiver were preset at the factory. They should only be readjusted by a qualified technician who is familiar with this transceiver and has the necessary test equipment. Attempting service or alignment without factory authorization can void the transceiver warranty.

When operated properly, the transceiver will provide years of service and enjoyment without requiring further realignment. The information in this section gives some general service procedures requiring little or no test equipment.

SERVICE

If it is ever necessary to return the equipment to your dealer or service center for repair, pack the transceiver in its original box and packing material. Include a full description of the problems experienced. Include your telephone number along with your name and address in case the service technician needs to call for further explanation while investigating your problem. Don't return accessory items unless you feel they are directly related to the service problem. You may return your transceiver for service to the authorized KENWOOD Dealer from whom you purchased it or any authorized KENWOOD service center. A copy of the service report will be returned with the transceiver. Please do not send subassemblies or printed circuit boards. Send the complete transceiver.

Tag all returned items with your name and call sign for identification. Please mention the model and serial number of the transceiver in any communication regarding the problem.

SERVICE NOTE

Dear YL/OM,

If you desire to correspond on a technical or operational problem, please make your note short, complete, and to the point. Help us help you by providing the following:

- 1 Model and serial number of equipment
- 2 Question or problem you are having
- 3 Other equipment in your station pertaining to the problem
- 4 Meter readings
- 5 Other related information

Caution: Do not pack the equipment in crushed newspapers for shipment! Extensive damage may result during rough handling or shipping.

Note:

- 1 Record the date of purchase, serial number and dealer from whom the transceiver was purchased.
- 2 For your own information, retain a written record of any maintenance performed on the transceiver.
- 3 When claiming warranty service, please include a photocopy of the bill of sale, or other proof of purchase showing the date of sale.

CLEANING

The buttons, controls and case of the transceiver are likely to become soiled after extended use. Remove the controls from the transceiver and clean them with a neutral detergent and warm water. Use a neutral detergent (no strong chemicals) and a damp cloth to clean the case and front panel.

9 MAINTENANCE AND ADJUSTMENTS

TROUBLESHOOTING

The problems described in this section are caused mostly by improper operation or connection of the transceiver and its associated equipment. Some operating tips are included which may resolve perceived problems. When you experience trouble, review this information before requesting help. If the problem persists, contact an authorized agent or service facility.

RECEPTION

Problem Symptom	Probable Cause	Corrective Action
Switching the power on results in no display data and no sound.	<ol style="list-style-type: none"> 1 The DC power cable plug is not inserted completely into the 13.8 V DC connector on the transceiver rear panel. 2 The fuse is open. 3 The DC power supply is off. 	<ol style="list-style-type: none"> 1 Insert the DC power cable plug securely into the connector on the transceiver. 2 Investigate the cause of the open fuse. Install a new fuse with the same rating. 3 Switch on the DC power supply.
Switching the power on results in incorrect display data.	Malfunctioning microprocessor.	<ol style="list-style-type: none"> 1 Check the output voltage of the DC power supply. (13.8V \pm15%) For mobile installations, use the vehicle battery. (11.8 V to 16 V) 2 Switch the power on while holding down the A/B button(Partial Reset) or the A=B button(Full Reset).
Switching the power on results in a display readout of 14.000.0 MHz USB with no data stored in any of the memories.	The life of the memory backup battery is over.	Refer to page 31.
No signals can be received even though an antenna is connected, or the receive sensitivity is low.	<ol style="list-style-type: none"> 1 The squelch is set incorrectly. 2 The attenuator is on. Point function is on. 3 The Advanced Intercept 4 The antenna is not tuned. 5 PTT is on. 	<ol style="list-style-type: none"> 1 Turn the SQL control fully counterclockwise. 2 Turn the ATT off. 3 Turn the AIP off. 4 If using an antenna tuner, retune. Otherwise, check the resonance of your antenna at the receive frequency. 5 Release the PTT.
Received signals cannot be understood or demodulated at all.	The wrong modulation mode is selected.	Select the correct mode.
Operating the RIT control does not change the frequency.	The Receiver Incremental Tuning function is off.	Press the RIT button.
SSB audio quality is very poor; the high or low audio frequencies are absent.	<ol style="list-style-type: none"> 1 The IF SHIFT control is adjusted incorrectly. 2 The optional 0.5kHz filter is selected. 	<ol style="list-style-type: none"> 1 Return the IF SHIFT to the center detent position. 2 Select the standard 2.4kHz SSB filter.
Operating the UP/DOWN buttons or the Tuning control does not change the frequency.	The Frequency Lock function is on.	Press the F.LOCK button.
Scan doesn't work.	The squelch is set incorrectly.	Adjust the SQL control to just eliminate background noise.
Memory scan doesn't work.	<ol style="list-style-type: none"> 1 Data is not stored in two or more memory channels. 2 All memory channels are locked out. 3 With Group Scan selected, the channel you want to scan is in a different group. 	<ol style="list-style-type: none"> 1 Store frequency data in at least two memory channels. 2 Unlock the memory channels you want to scan. 3 Select All-channel Scan, or program the desired frequency within the current group.

9 MAINTENANCE AND ADJUSTMENTS

Problem Symptom	Probable Cause	Corrective Action
Scanning desired frequencies is difficult because there are so many memories, you can't find the frequencies you want to scan.	You have programmed the memories randomly without using some kind of organizing system.	Follow a system for programming memories whereby each memory group contains one mode or one band, for example.
Listening to AM international broadcast stations in the shortwave bands is difficult due to interference from adjacent stations.	<ol style="list-style-type: none"> 1 The receive bandwidth is too wide. 2 Interference is being received in one of the sidebands of the AM signal. 	<ol style="list-style-type: none"> 1 Select the narrow 2.4kHz SSB filter. In this case, tune slightly off the center frequency of the AM station to increase the intelligibility of the signal. 2 Select either the USB or LSB mode, then tune the frequency to cancel the AM carrier heterodyne tone.
The transceiver switches off after extended periods of listening for no apparent reason.	The Automatic Power Off function is on.	Turn the APO off.

Note: Weak heterodyne tones may be audible when tuning certain frequencies. This is not a defect. These tones are caused by the relationships of various frequencies generated within the transceiver.

TRANSMISSION

Problem Symptom	Probable Cause	Corrective Action
No power is output or output power is low.	<ol style="list-style-type: none"> 1 The microphone is connected incorrectly. 2 The antenna is connected incorrectly. 3 The antenna tuner match is inappropriate, possibly due to the antenna impedance being outside the tuning range of the tuner. 4 You are transmitting out of band. 5 The automatic power down circuit is active due to high transmitter temperature. 	<ol style="list-style-type: none"> 1 Insert the microphone completely. 2 Connect the antenna correctly. 3 Adjust the antenna. 4 Select a frequency within the Amateur bands. The "ON AIR" indicator must light. 5 Reduce your transmit duty cycle; receive for longer periods between transmissions. Use lower power.
The linear amplifier does not function.	<ol style="list-style-type: none"> 1 The linear amplifier relay is not switching to the transmit state. 2 The interconnect cable is attached incorrectly or not at all. 	<ol style="list-style-type: none"> 1 Ensure the relay is operating. 2 Check the interconnect cable between the relay connector on the transceiver rear panel and the amplifier. Attach the cable correctly.
Transmissions result in no contacts, especially while calling CQ.	<ol style="list-style-type: none"> 1 The transmit frequency is different from the receive frequency since the RIT function is on. 2 You are using split frequency by mistake. 3 You are transmitting on the wrong sideband in the SSB mode. 	<ol style="list-style-type: none"> 1 Press the RIT button. 2 Push the SPLIT button. 3 Push the SSB/CW button to select the correct sideband.

9 MAINTENANCE AND ADJUSTMENTS

ADJUSTMENTS

Removing the transceiver covers provides access to the following variable resistors:

Top cover removed:

Sidetone volume (VR 5)

Beep volume (VR 6)

Microphone gain (only SSB or AM mode, VR 7)

Bottom cover removed:

FM modulation level (VR 1)

In addition, the fuse mounted under the shield can be replaced with the bottom cover removed.

■ Removal of the Top and Bottom Covers

Remove the 7 screws as shown. Lift off the transceiver top cover.

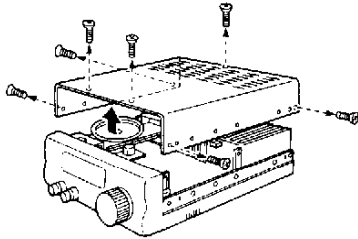

Remove the 9 screws as shown. Lift off the transceiver bottom cover.

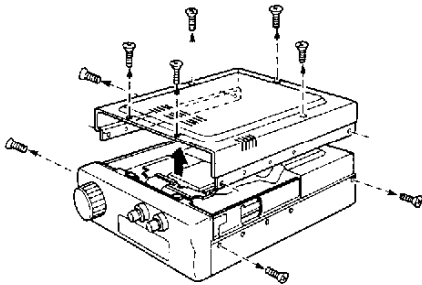

■ Location of the Variable Resistors

The variable resistors are located at the positions shown.

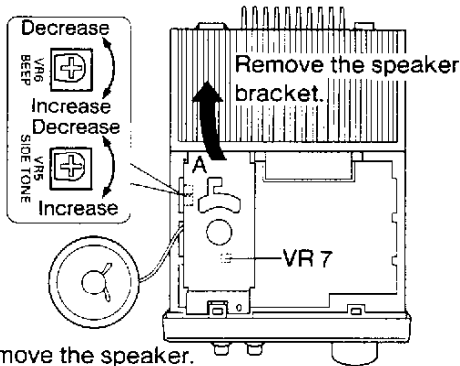

Remove the speaker.

Note:

- 1 Dress the speaker wires near Point <A> before reinstalling the speaker.
- 2 Be sure not to scrape or pinch any wires when reinstalling the covers.

REFERENCE FREQUENCY CALIBRATION

This section describes the method for calibrating the reference frequency. However, a complete calibration was done just prior to shipment, therefore no further adjustment should be necessary. With the optional SO-2 installed, calibration is not possible.

- 1 Remove the top and bottom covers from the transceiver.
- 2 Connect the DC power cable and switch the power on.
- 3 Insert one end of the supplied calibration cable onto TP 6 of the PLL board.
- 4 Insert the other end of the calibration cable onto TP 3 (CAL terminal) of the RF board.
- 5 Tune in a Standard Time and Frequency station such as WWV on 5, 10, or 15 MHz.
- 6 The WWV signal will mix with the calibration signal to produce a beat frequency. Adjust the trimmer, TC 1, for the lowest frequency of beat note.
- 7 After completing the adjustment, remove the calibration cable.

Note: When reinstalling the boards, take care not to damage the wires.

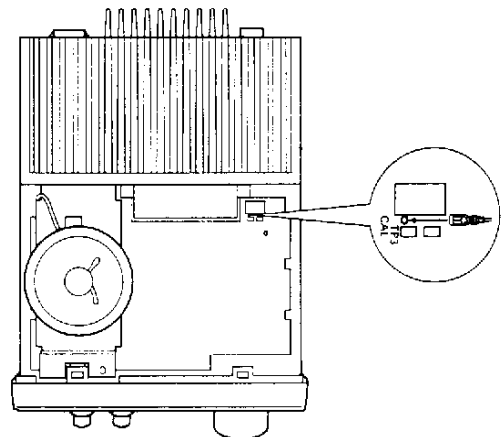
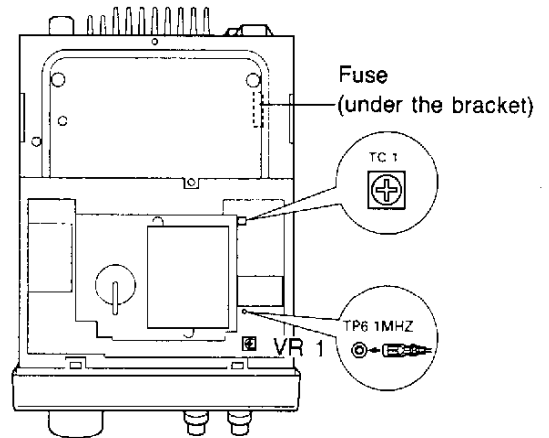

10 OPTIONS INSTALLATION

Caution: UNPLUG THE DC POWER CABLE BEFORE BEGINNING INSTALLATION.

FILTER

- 1 Remove the transceiver top cover (7 screws).

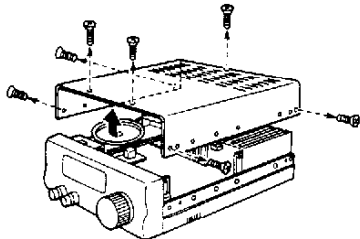

- 2 Remove the speaker and speaker bracket.
- 3 Remove the screw that secures the small board to the main board.
- 4 Remove the small board from the main board. Note the orientation.

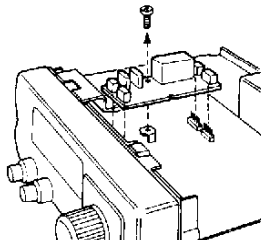

- 5 Solder the filter onto the board. Use a low power iron (25W) and rosin core solder. Do not overheat the PC board and lift foil traces, and do not use excess solder and cause a solder bridge (short). Clip the filter leads flush to the PC board after soldering.

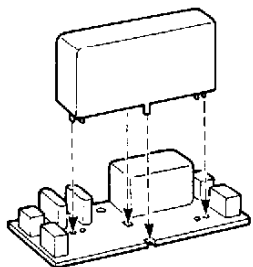

- 6 Reinstall the small board with the screw. Orient the board as it was before removal.
- 7 Reinstall the speaker bracket and speaker.
- 8 Reinstall the top cover.

Note: Be careful not to pinch your fingers nor the wires.

MENU SET-UP CHANGE

To use the new filter, change the Menu Set-up with this procedure:

- 1 Connect the DC power cable.
- 2 Switch on the power.
- 3 Hold the **F.LOCK** button for more than two seconds to enter the Menu Set-up mode.
- 4 Press the **A/B** button to select Menu **A**.
- 5 Select Menu No. 03 with the tuning control.
- 6 Select the SSB or CW mode.
- 7 Select 0.5 kHz with the **UP** or **DOWN** button. The -N indicator appears in the modulation mode area.
- 8 Press the **CLR** or **F.LOCK** button to exit Menu Set-up.

10 OPTIONS INSTALLATION

TCXO UNIT (SO-2)

- 1 Remove the transceiver bottom cover (9 screws).

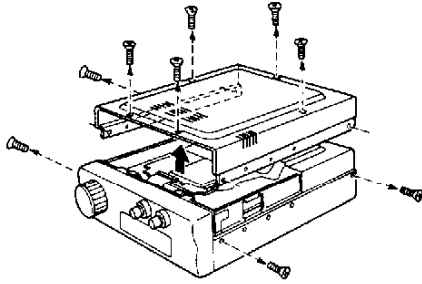

- 2 Remove the shield covering the control board (2 screws).

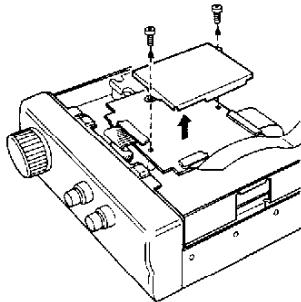

- 3 **CAREFULLY** remove the 3 flat cables from the control board, and lift the board.

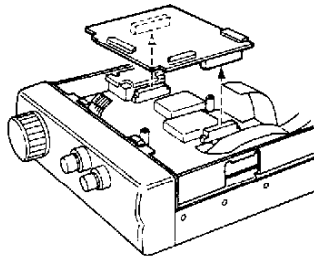

- 4 **CAREFULLY** remove the 3 coaxial cable connectors (CN2, CN3, CN4) and the 4-pin connector (CN1) from the PLL board. Do not pull on the wires to remove CN1. Remove the 8 screws holding the PLL board.

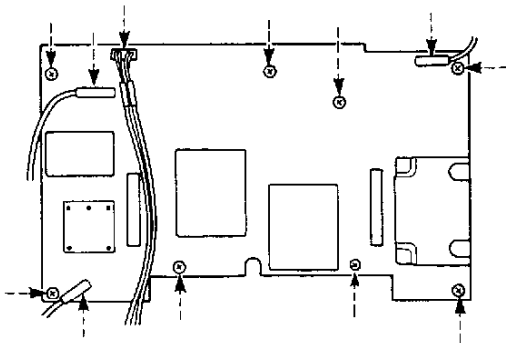

- 5 Lift the PLL board.
- 6 Position and solder the SO-2. Use a low power iron (25W) and rosin core solder. Do not overheat the PC board and lift foil traces, and do not use excess solder and cause a solder bridge (short). Clip the SO-2 leads flush to the PC board after soldering.

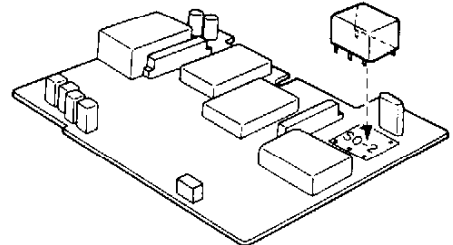







- 7 Cut the jumper wires at W1 and W2 on the PLL board.
- 8 Re-position the PLL board.
- 9 Tighten the 8 screws to secure the PLL board. Reconnect the 3 coaxial cable connectors (CN2, CN3, CN4) and the 4-pin connector (CN1).
- 10 Reinstall the control board and **CAREFULLY** reconnect the flat cables.
- 11 Reinstall the shield using the 2 screws.
- 12 Reinstall the bottom cover (9 screws).

Note: Do not pinch your fingers nor any wires while reassembling.

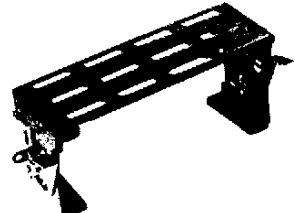
OPTIONAL ACCESSORIES

<p>PS-33 Regulated DC Power Supply</p> 	<p>MC-43S Microphone with UP and DOWN buttons</p> 	
<p>PS-53 Regulated DC Power Supply (with AT-300)</p> 	<p>MC-60A Unidirectional dynamic desk microphone with UP and DOWN buttons</p> 	
<p>PG-2Y DC Power Cable (4m)</p> 	<p>PG-2X DC Power Cable (2m)</p> 	<p>MC-80 Unidirectional electret condenser desk microphone with UP and DOWN buttons</p> 
<p>SP-41 External Speaker</p> 	<p>MC-85 Unidirectional electret condenser desk microphone with UP and DOWN buttons</p> 	
<p>SP-50B External Speaker</p> 	<p>S0-2 TCXO Unit</p> 	

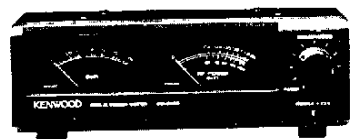
OPTIONAL ACCESSORIES

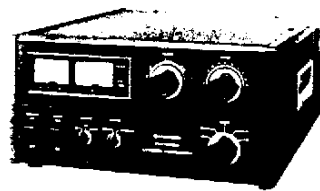
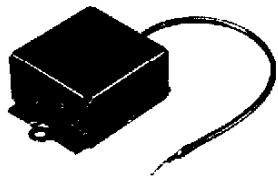
<p>YK-107C CW Filter</p>  <p>Center frequency : 10.695 MHz Pass band : 0.5 kHz</p>	<p>MB-13 Mounting Bracket</p> 
<p>AT-50 Automatic Antenna Tuner</p> 	<p>LF-30A Low-pass Filter</p> 
<p>PG-4M Control Cable</p> 	<p>SW-2100 SWR Meter</p> 
<p>AT-300 Automatic Antenna Tuner</p> 	<p>MA-5 Mobile Antenna</p> 
<p>TL-922/TL-922A Linear Amplifier</p> 	<p>IF-10D Interface Unit</p> 

SPECIFICATIONS

			Specifications			
GENERAL	Mode		J3E(LSB, USB), A1A(CW), A3E(AM), F3E(FM)			
	Number of memory channels		100			
	Antenna impedance		50 ohms			
	Supply voltage		DC 13.8 V \pm 15%			
	Grounding method		Negative ground			
	CURRENT	Current	Transmit (maximum output)	20.5 A		
			Receive (standby)	1.45 A		
	Usable temperature range		-20°C to +60°C (-4°F to +140°F)			
	Frequency stability (-10°C to +50°C)		Within \pm 10 PPM			
	Frequency accuracy (at room temperature)		Within \pm 10 PPM			
	Dimensions [W×H×D] (): Projections included		179×60×233mm (180×69×270mm)			
	Weight (main unit only)		2.9 kg (6.4 lbs)			
TRANSMITTER	Transmit frequency range	160 m band	1.800 ^{*1}	to	2.000 ^{*2} MHz	
		80 m band	3.500	to	4.000 ^{*3} MHz	
		40 m band	7.000	to	7.300 ^{*4} MHz	
		30 m band	10.100	to	10.150 MHz	
		20 m band	14.000	to	14.350 MHz	
		17 m band	18.068	to	18.168 MHz	
		15 m band	21.000	to	21.450 MHz	
		12 m band	24.890	to	24.990 MHz	
		10 m band	28.000	to	29.700 MHz	
POWER OUTPUT	Power output	1.9~28 MHz	SSB, CW, FM	Max.	100 W	
				Med.	50 W	
				Min.	10 W	
		AM	Max.	25 W		
			Med.	17 W		
			Min.	5.5 W		
MODULATION TYPE	Modulation type	SSB	Balanced			
		FM	Variable reactance			
		AM	Low-level			
Spurious emissions		-50 dB or less				
Carrier suppression (modulation frequency 1.5 kHz)		40 dB or more				

*1: Europe, France: 1.810 MHz; Belgium: 1.830 MHz

*2: Belgium, France: 1.850 MHz

*3: Europe: 3.800 MHz

*4: Europe: 7.100 MHz

SPECIFICATIONS

			Specifications	
Unwanted sideband suppression (modulation frequency 1.5 kHz)			40 dB or more	
Maximum FM deviation			5 kHz $\begin{matrix} +10\% \\ -20\% \end{matrix}$	
Transmit frequency characteristics (-10dB)			400 to 2600 Hz	
Microphone impedance			600 ohms	
Circuit type			SSB, CW, AM: Double conversion FM: Triple conversion	
Receive frequency range			500 kHz to 30 MHz	
R	Intermediate frequency		SSB, CW, AM	1st : 73.045 MHz, 2nd : 10.695 MHz
			FM	1st : 73.045 MHz, 2nd : 10.695 MHz, 3rd : 455 kHz
E	Sensitivity	SSB, CW (at 10dB (S+N)/N)	500 kHz~1.5 MHz	Less than 0.25 μ V
			1.5 MHz~1.7 MHz	Less than 0.35 μ V
			1.7 MHz~30 MHz	Less than 0.25 μ V
C	Sensitivity	AM (at 10dB (S+N)/N)	500 kHz~1.5 MHz	Less than 2.5 μ V
			1.5 MHz~1.7 MHz	Less than 3.5 μ V
			1.7 MHz~30 MHz	Less than 2.5 μ V
E	Sensitivity	FM (at 12 dB SINAD)	28 MHz~30 MHz	Less than 0.5 μ V
V	Selectivity		SSB, CW	-6 dB: More than 2.2 kHz, -60 dB: Less than 4.8 kHz
			AM	-6 dB: More than 5 kHz, -60 dB: Less than 40 kHz
			FM	-6 dB: More than 12 kHz, -50 dB: Less than 25 kHz
E	Image rejection		More than 70 dB	
	1st IF rejection		More than 80 dB	
R	RIT shift frequency range		10 Hz steps	\pm 1.1 kHz
			20 Hz steps	\pm 2.2 kHz
Squelch sensitivity	SSB, CW AM	500 kHz~30 MHz	Less than 2 μ V	
	FM	28 MHz~30 MHz	Less than 0.32 μ V	
Audio output (8 ohms, 5% distortion)			2.0 W	
Audio output impedance			8 ohms	

Note

- 1 Specifications are subject to change without notice or obligation due to ongoing technological developments.
- 2 Remember to keep the transmit output power within the power limitations of your license.

KENWOOD