



INSTRUCTION MANUAL

HF/50 MHz TRANSCEIVER **IC-7410**



FOREWORD

Thank you for making the IC-7410 your radio of choice. We hope you agree with Icom's philosophy of "technology first." Many hours of research and development went into the design of your IC-7410.

FEATURES

- High receiver performance: third-order intercept point (IP3) of +30 dBm (HF bands only)
- Simple band scope function
- ± 0.5 ppm of high frequency stability
- RTTY demodulator and decoder
- RS-BA1 compatible

IMPORTANT

READ THIS INSTRUCTION MANUAL CAREFULLY before attempting to operate the transceiver.

SAVE THIS INSTRUCTION MANUAL. This manual contains important safety and operating instructions for the IC-7410.

EXPLICIT DEFINITIONS

WORD	DEFINITION
⚠ DANGER!	Personal death, serious injury or an explosion may occur.
⚠ WARNING!	Personal injury, fire hazard or electric shock may occur.
CAUTION	Equipment damage may occur.
NOTE	If disregarded, inconvenience only. No risk of personal injury, fire or electric shock.

Spurious signals may be received near some frequencies.

These are made in the internal circuit and does not indicate a transceiver malfunction.

Icom, Icom Inc. and the Icom logo are registered trademarks of Icom Incorporated (Japan) in Japan, the United States, the United Kingdom, Germany, France, Spain, Russia and/or other countries. Microsoft, Windows and Windows Vista are registered trademarks of Microsoft Corporation in the United States and/or other countries.

All other products or brands are registered trademarks or trademarks of their respective holders.

SUPPLIED ACCESSORIES

The transceiver comes with the following accessories.

	Qty.
① Hand microphone	1
② DC power cable*1	1
③ Spare fuse (ATC 5 A)	1
④ Spare fuse (ATC 30 A)	2
⑤ ACC cable	1
⑥ 6.3 (d) mm plug	1
⑦ Ferrite EMI filter*2	1

*1 Differs depending on the version.

*2 Not supplied with the non-European versions.

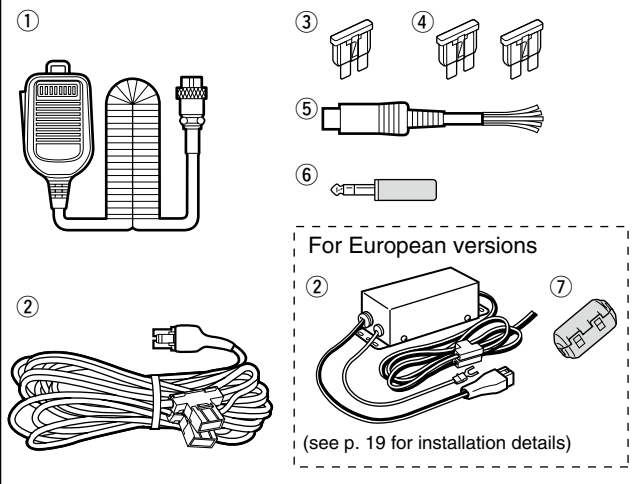

FCC INFORMATION

• FOR CLASS B UNINTENTIONAL RADIATORS:

This equipment has been tested and found to comply with the limits for a Class B digital device, pursuant to part 15 of the FCC Rules. These limits are designed to provide reasonable protection against harmful interference in a residential installation. This equipment generates, uses and can radiate radio frequency energy and, if not installed and used in accordance with the instructions, may cause harmful interference to radio communications. However, there is no guarantee that interference will not occur in a particular installation. If this equipment does cause harmful interference to radio or television reception, which can be determined by turning the equipment off and on, the user is encouraged to try to correct the interference by one or more of the following measures:

- Reorient or relocate the receiving antenna.
- Increase the separation between the equipment and receiver.
- Connect the equipment into an outlet on a circuit different from that to which the receiver is connected.
- Consult the dealer or an experienced radio/TV technician for help.

PRECAUTIONS

⚠ DANGER HIGH RF VOLTAGE! NEVER attach an antenna or internal antenna connector during transmission. This may result in an electrical shock or burn.

⚠ WARNING! NEVER operate the transceiver with a headset or other audio accessories at high volume levels. Hearing experts advise against continuous high volume operation. If you experience a ringing in your ears, reduce the volume or discontinue use.

⚠ WARNING! NEVER operate or touch the transceiver with wet hands. This may result in an electric shock or damage to the transceiver.

⚠ WARNING! NEVER apply AC power to the [DC13.8V] socket on the transceiver rear panel. This could cause a fire or damage the transceiver.

⚠ WARNING! NEVER cut the DC power cable between the DC plug and fuse holder. If an incorrect connection is made after cutting, the transceiver may be damaged.

⚠ WARNING! NEVER apply more than 16 V DC to the [DC13.8V] socket on the transceiver rear panel, or use reverse polarity. This could cause a fire or damage the transceiver.

⚠ WARNING! NEVER let metal, wire or other objects protrude into the transceiver or into connectors on the rear panel. This may result in an electric shock.

⚠ WARNING! Immediately turn OFF the transceiver power and remove the power cable if it emits an abnormal odor, sound or smoke. Contact your Icom dealer or distributor for advice.

⚠ WARNING! NEVER put the transceiver in any unstable place (such as on a slanted surface or vibrated place). This may cause injury and/or damage to the transceiver.

CAUTION: NEVER change the internal settings of the transceiver. This may reduce transceiver performance and/or damage to the transceiver.

In particular, incorrect settings for transmitter circuits, such as output power, idling current, etc., might damage the expensive final devices.

The transceiver warranty does not cover any problems caused by unauthorized internal adjustment.

CAUTION: NEVER block any cooling vents on the top, rear, sides or bottom of the transceiver.

CAUTION: NEVER expose the transceiver to rain, snow or any liquids.

CAUTION: NEVER install the transceiver in a place without adequate ventilation. Heat dissipation may be reduced, and the transceiver may be damaged.

DO NOT use harsh solvents such as benzine or alcohol when cleaning, as they will damage the transceiver surfaces.

DO NOT push the PTT switch when you don't actually desire to transmit.

DO NOT use or place the transceiver in areas with temperatures below $\pm 0^{\circ}\text{C}$ ($+32^{\circ}\text{F}$) or above $+50^{\circ}\text{C}$ ($+122^{\circ}\text{F}$).

DO NOT place the transceiver in excessively dusty environments or in direct sunlight.

DO NOT place the transceiver against walls or putting anything on top of the transceiver. This may overheat the transceiver.

Always place unit in a secure place to avoid inadvertent use by children.

BE CAREFUL! If you use a linear amplifier, set the transceiver's RF output power to less than the linear amplifier's maximum input level, otherwise, the linear amplifier will be damaged.

BE CAREFUL! The rear panel will become hot when operating the transceiver continuously for long periods of time.

USE only the specified microphone. Other manufacturers' microphones have different pin assignments, and connection to the IC-7410 may damage the transceiver or microphone.

During maritime mobile operation, keep the transceiver and microphone as far away as possible from the magnetic navigation compass to prevent erroneous indications.

Turn OFF the transceiver's power and/or disconnect the DC power cable when you will not use the transceiver for long period of time.

For U.S.A. only

CAUTION: Changes or modifications to this device, not expressly approved by Icom Inc., could void your authority to operate this device under FCC regulations.

TABLE OF CONTENTS

FOREWORD	i
IMPORTANT	i
EXPLICIT DEFINITIONS	i
SUPPLIED ACCESSORIES	i
FCC INFORMATION	i
PRECAUTIONS	ii
TABLE OF CONTENTS	iii
1 PANEL DESCRIPTION	1–14
■ Front panel	1
■ Rear panel.....	8
◇ ACC socket information	10
■ LCD display	11
■ Function display	13
◇ M1 (Menu 1)	13
◇ Function keys on M1 (Menu 1)	13
◇ M2 (Menu 2)	14
◇ Function keys on M2 (Menu 2)	14
2 INSTALLATION AND CONNECTIONS	15–22
■ Selecting a location	15
■ Grounding	15
■ Antenna connection	15
■ Required connections	16
◇ Front panel.....	16
◇ Rear panel	16
■ Advanced connections	17
◇ Front panel.....	17
◇ Rear panel	17
■ External keypad connections	18
■ External antenna tuner connection	18
◇ Connecting the AH-4	18
■ Power supply connections.....	19
■ Connecting to a DC power supply.....	19
◇ Connecting to the PS-126 DC POWER SUPPLY	19
◇ Connecting to a non-Icom DC POWER SUPPLY	19
■ Linear amplifier connections	20
◇ Connecting the IC-PW1/PW1EURO	20
◇ Connecting a non-Icom linear amplifier	21
■ Microphone connector information	22
■ Microphones.....	22
◇ HM-36	22
◇ SM-50 (option)	22
3 BASIC OPERATION	23–34
■ Before first applying power	23
■ Turning ON (CPU resetting)	23
■ VFO description.....	24
◇ Selecting the VFO A/B	24
◇ VFO equalization	24
■ Selecting VFO/Memory mode	24
■ Selecting a frequency band.....	25
◇ Using the band stacking registers.....	25
■ Frequency setting.....	26
◇ Tuning with [DIAL]	26
◇ Direct frequency entry with the keypad.....	26
◇ Quick Tuning function.....	27
◇ Selecting 1 Hz step	27
◇ 1/4 Tuning Step function	27
◇ Auto Tuning Step function	28
◇ About the 5 MHz frequency band operation (USA version only).....	28
◇ Band edge warning beep.....	29
◇ Programming the user band edge	30
■ Operating mode selection	31
■ Volume setting.....	31
■ Squelch and receive (RF) sensitivity	32
■ Voice synthesizer operation	33
■ Meter Display selection	33
■ Basic transmit operation.....	34
◇ Transmitting.....	34
◇ Microphone gain adjustment.....	34

4 RECEIVE AND TRANSMIT	35–52
■ Operating SSB	35
■ Operating CW	36
◇ About the CW reverse mode	37
◇ About CW pitch control	37
◇ About keying speed	37
◇ CW sidetone function	37
■ Electronic keyer functions	38
◇ Memory keyer menu construction	38
◇ Memory keyer send menu	39
◇ Editing a memory keyer	40
◇ Contest number Set mode	41
◇ Keyer Set mode	42
■ Operating RTTY (FSK)	44
■ RTTY functions	45
◇ RTTY menu construction	45
◇ About the RTTY reverse mode	46
◇ RTTY decoder	46
◇ Twin Peak Filter	47
◇ RTTY Set mode	48
■ Operating AM/FM	49
■ Tone squelch operation	50
■ Tone scan operation	51
■ Repeater operation	51
◇ Repeater access tone frequency setting	52
◇ Transmit frequency monitor check	52

5 FUNCTIONS FOR RECEIVE	53–61
■ RIT function	53
◇ RIT Monitor function	53
■ Simple band scope	54
■ Preamplifier	55
■ Attenuator	55
■ AGC function	56
◇ AGC speed selection	56
◇ Setting the AGC time constant	56
■ IF filter selection	57
◇ IF filter selection	57
◇ Filter passband width setting	57
◇ 1st IF filter selection	58
◇ IF (DSP) filter shape	58
■ Twin PBT operation	59
■ Noise Blanker	60
◇ NB Set mode	60
■ Meter Peak Hold function	60
■ Noise Reduction	61
■ Dial Lock function	61
■ Notch function	61
6 FUNCTIONS FOR TRANSMIT	62–68
■ VOX function	62
◇ Using the VOX function	62
◇ Adjusting the VOX function	62
■ Break-in function	63
◇ Semi Break-in operation	63
◇ Full Break-in operation	63
■ Speech Compressor	64
■ Transmit filter width selection	64
■ ΔTX function	65
◇ ΔTX Monitor function	65
■ Monitor function	65
■ Split frequency operation	66
■ Quick Split function	67
◇ Split Lock function	67
■ Measuring SWR	68
◇ Spot measurement	68
◇ Plot measurement	68

1
2
3
4
5
6
7
8
9
10
11
12
13
14
15
16
17

TABLE OF CONTENTS

7 MEMORY OPERATION	69–74	9 ANTENNA TUNER OPERATION	82–84
■ General description	69	■ Antenna connection and selection	82
◇ Memory channel contents.....	69	■ Antenna tuner operation.....	83
■ Memory channel selection	69	◇ Tuner operation.....	83
◇ Selection in the VFO mode	69	◇ Manual tuning	83
◇ Selection in the Memory mode	69	■ Optional external tuner operation.....	84
■ Memory channel programming	70		
◇ Programming in the VFO mode	70	10 SET MODE	85–91
◇ Programming in the Memory mode.....	70	■ Set mode description	85
■ Memory clearing	71	◇ The Set mode settings	85
■ Memory contents copying	72	■ Tone Control Set mode description	90
◇ Copying in the VFO mode.....	72	◇ The Tone control Set mode settings.....	90
◇ Copying in the Memory mode.....	72		
■ Memory name programming	73	11 DATA COMMUNICATION	92–93
■ Memo Pad function	74	■ Connections	92
◇ Writing the displayed data into a memo pad..	74	◇ When connecting to [ACC].....	92
◇ Calling up a memo pad.....	74	◇ When connecting to [MIC]	92
		■ Packet (AFSK) operation.....	93
		◇ Frequency display during AFSK operation .	93
8 SCANS	75–81		
■ Scan types	75	12 OPTION INSTALLATION	94–95
■ Preparation.....	76	■ Opening the transceiver's case	94
■ Voice Squelch Control function	76	■ FL-430/FL-431 1ST IF FILTER installation.....	95
■ Scan Set mode.....	77		
■ Programmed scan/Fine programmed scan (VFO mode)	78	13 MAINTENANCE	96–100
◇ About the Fine programmed scan.....	78	■ Troubleshooting	96
■ Memory scan (Memory mode)	79	◇ Transceiver power	96
◇ Memory scan	79	◇ Transmit and receive	96
◇ Select Memory scan	80	◇ Scanning.....	97
◇ Setting/Cancelling Select Memory channels .	80	◇ Display	97
■ Δ F scan and Fine Δ F scan	81	■ Dial tuning tension adjustment	97
◇ About the Fine Δ F scan	81	■ Frequency calibration (approximate).....	98
		■ About protection displays	98
		■ Fuse replacement	99
		◇ DC power cable fuse replacement.....	99
		◇ Circuitry fuse replacement.....	99
		■ Resetting the CPU	100
		◇ Partial reset.....	100
		◇ All reset.....	100

14 CONTROL COMMAND	101–108
■ Remote jack (CI-V) information	101
◇ CI-V connection example	101
◇ Data format	101
◇ Command table	102
◇ Data content description	106
15 SPECIFICATIONS	109–110
■ General	109
■ Transmitter	109
■ Receiver	110
■ Antenna tuner	110
16 OPTIONS	111–112
■ Options	111
17 CE	113–114

1
2
3
4
5
6
7
8
9
10
11
12
13
14
15
16
17

Front panel

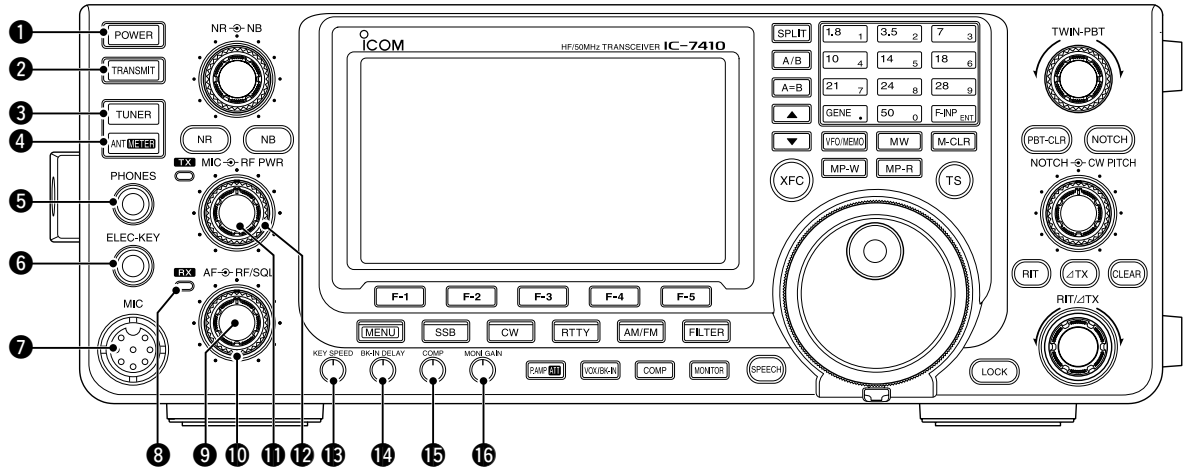

1 POWER SWITCH [POWER] (p. 23)

- ➔ Push to turn ON the transceiver power.
 - First, confirm the DC power source is turned ON.
- ➔ Hold down for 1 second to turn OFF the power.

2 TRANSMIT SWITCH [TRANSMIT] (p. 34)

- ➔ Push to select transmit or receive.
- While transmitting, the TX indicator (21) lights red.
- While receiving or when the squelch opens, the RX indicator (8) lights green.

3 ANTENNA TUNER SWITCH [TUNER] (pp. 83, 84)

- ➔ Push to turn the internal antenna tuner ON or OFF (bypass).
- When the tuner is ON, "TUNE" appears.
- The internal antenna tuner settings can be memorized in each frequency band.
- ➔ Hold down for 1 second to manually start the antenna tuner.
- If the tuner cannot tune the antenna within 20 seconds, the tuning circuit is automatically bypassed.

4 ANTENNA•METER SWITCH [ANT•METER] ANTENNA SWITCH Operation

- ➔ Push to select either the ANT1 or ANT2 connector. (p. 82)

METER SWITCH Operation

- ➔ Hold down for 1 second to display either the COMP or SWR meter in addition to the ALC meter. (p. 33)

5 HEADPHONE JACK [PHONES] (p. 17)

- ➔ Plug in standard stereo headphones. Impedance: 8 to 16 Ω.
- Output power: 5 mW with an 8 Ω load.
- When headphones are connected, the internal speaker, and any external speaker, are disabled.

6 ELECTRONIC KEYS JACK [ELEC-KEY]

- ➔ Plug in a bug or paddle type key to use the internal electronic keyer for CW operation. (p. 16)
- Select the ELEC-KEY, BUG KEY or Straight key keyer type in the "Keyer Type" item of the Keyer Set mode.
- When a straight key is connected, "Straight key" must be selected in the "Keyer Type" item of the Keyer Set mode. (p. 43)
- A straight key jack is located on the rear panel. See [KEY] on pages 8 and 16.
- You can reverse the keyer paddle polarity (dot and dash) in the "Paddle Polarity" item of the Keyer Set mode. (p. 42)
- Four keyer memory channels are available for your convenience. (p. 40)

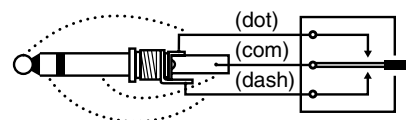

7 MICROPHONE CONNECTOR [MIC]

- ➔ Plug in the supplied or optional microphone.
- See page 22 for appropriate microphones and microphone connector information.

8 RX INDICATOR

- ➔ Lights green while receiving or when the squelch opens.

9 AF CONTROL [AF] (inner control; p. 31)

- ➔ Rotate to adjust audio output level to the speaker or headphones.

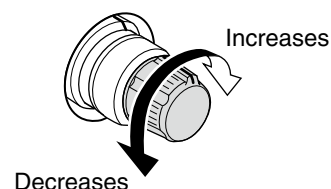

10 RF GAIN CONTROL/SQUELCH CONTROL [RF/SQL] (outer control; p. 32)

Rotate to adjust the RF gain and squelch threshold level.

The squelch removes noise output to the speaker when no signal is received (closed condition).

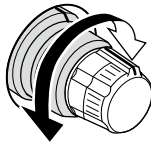

- The squelch is particularly effective in FM, but also works in other modes.
- The 12 to 1 o'clock position is recommended for the most effective use of the [RF/SQL] control.
- [RF/SQL] operates as only an RF gain control in SSB, CW and RTTY (Squelch is fixed open), or a squelch control in AM and FM (RF gain is fixed at maximum sensitivity), when the "RF/SQL Control" item is set to "Auto" in the Set mode. (p. 86)

• When used as an RF gain/squelch control

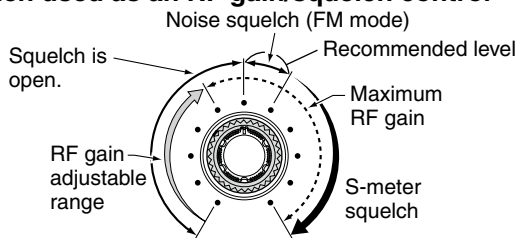

• When used as an RF gain control

(Squelch is fixed open; SSB, CW and RTTY only)

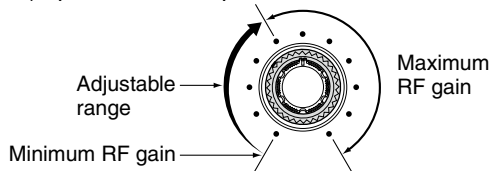

While rotating the RF gain control, a faint noise may be heard. This comes from the DSP unit and does not indicate an equipment malfunction.

• When used as a squelch control

(RF gain is fixed at maximum.)

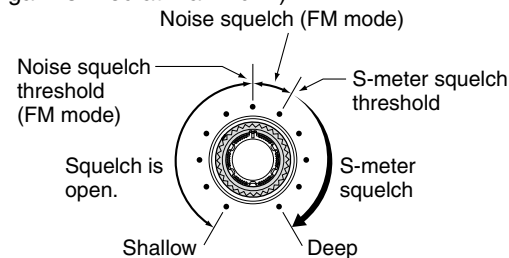

11 MIC GAIN CONTROL [MIC] (inner control; p. 34)

Rotate to adjust the microphone gain.

- The transmit audio tone in the SSB, AM and FM modes can be independently adjusted in the Tone Control Set mode. (pp. 90, 91)

✓ How to set the microphone gain.

While speaking at normal voice level, adjust the microphone gain so that in the SSB or AM modes, the ALC meter swings within the ALC zone.

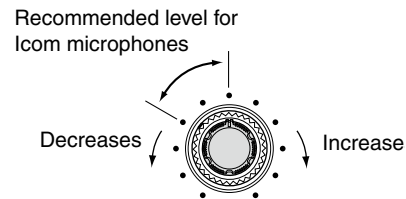

12 RF POWER CONTROL [RF PWR]

(outer control; p. 34)

Rotate to continuously vary the RF output power between 2 W (minimum) and 100 W (maximum). (AM: between 2 W and 27 W).

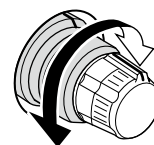

13 ELECTRONIC CW KEYSPEED CONTROL [KEY SPEED]

(p. 37)

(Mode: CW)

Rotate to adjust the keying speed of the internal electronic CW keyer to between 6 wpm (minimum) and 48 wpm (maximum).



14 BREAK IN DELAY CONTROL [BK-IN DELAY]

(p. 63)

(Mode: CW)

Rotate to adjust the transmit-to-receive switching delay time for the Semi Break-in function.



15 COMPRESSOR CONTROL [COMP] (p. 64)

(Mode: SSB)

Rotate to adjust the compression level.



16 MONITOR GAIN CONTROL [MONI GAIN] (p. 65)

Rotate adjust the monitor level for the clearest audio output.



1 PANEL DESCRIPTION

■ Front panel (continued)

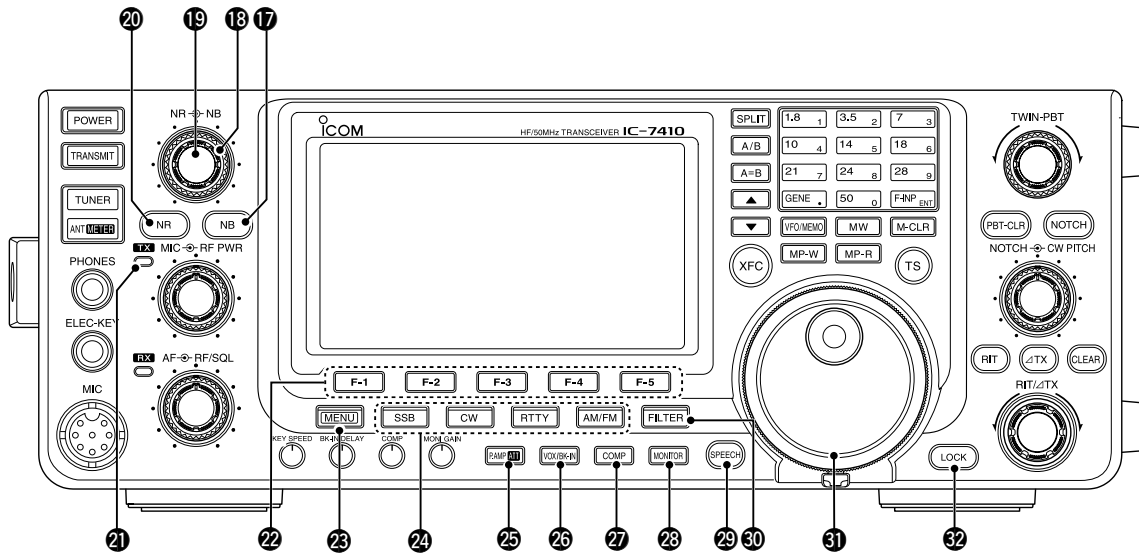

17 NOISE BLANKER SWITCH [NB] (p. 60)

- ➔ Push to turn the Noise Blanker ON or OFF. The Noise Blanker reduces pulse-type noise such as that generated by vehicle ignition systems. The Noise Blanker cannot be used in the FM mode, and is not effective for non-pulse-type noise.
 - “NB” appears when the Noise Blanker is ON.
- ➔ Hold down for 1 second to display the “NB” screen. Push to return to the previous screen display.

18 NOISE BLANKER LEVEL CONTROL [NB]

- (outer control; p. 60)
- Rotate to adjust the noise blanker threshold level when the Noise Blanker is ON. Set for maximum readability.
- To use this control, first push [NB] (17).

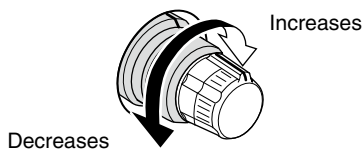

19 NOISE REDUCTION LEVEL CONTROL [NR]

- (inner control; p. 61)
- Rotate to adjust the DSP noise reduction level when the Noise Reduction is ON. Set for maximum readability.
- To use this control, first push [NR] (20).

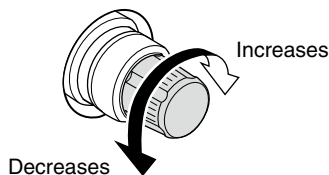

20 NOISE REDUCTION SWITCH [NR] (p. 61)

- Push to turn DSP Noise Reduction ON or OFF.
- “NR” appears when Noise Reduction is ON.

21 TX INDICATOR

Lights red while transmitting.

22 FUNCTION SWITCHES [F1]–[F5] (pp. 13, 14)

- Push to select the function which is indicated on the LCD display above each switch.
- The functions vary, depending on the selected menu and the operating mode.

23 MENU SWITCH [MENU] (pp. 13, 14)

- ➔ Push to change the set of functions assigned to switches ([F-1] to [F-5]).
 - Toggles between the function menus, M1 (Menu 1) and M2 (Menu 2).
- ➔ Hold down for 1 second to enter the Set mode. Push to return to the previous screen display.

24 MODE SWITCHES

- Push to select your desired operating mode. (p. 31)
- The built-in speech synthesizer announces the selected mode when the “SPEECH [MODE] SW” item is set to “ON” in the Set mode. (p. 87)

[SSB]

- ➔ Push to alternately select the USB or LSB modes.
 - “USB” or “LSB” appears.
- ➔ In the SSB mode, hold down for 1 second to select the SSB data mode (USB-D, LSB-D).
 - “D” appears in addition to “USB” or “LSB.”
- ➔ In the SSB data mode, push to return to the normal SSB mode.

[CW]

- Push to alternately select the CW and CW-R (CW reverse) modes.
- “CW” or “CW-R” appears.

[RTTY]

Push to alternately select the RTTY and RTTY-R (RTTY reverse) modes.

- “RTTY” or “RTTY-R” appears.

[AM/FM]

- ➔ Push to alternately select the AM or FM modes.
 - “AM” or “FM” appears.
- ➔ Hold down for 1 second to select the AM or FM data mode (AM-D/FM-D).
 - “D” appears in addition to “AM” or “FM.”
- ➔ In the data mode, push to return to the normal AM or FM mode.

25 PREAMP•ATTENUATOR SWITCH [P.AMP•ATT] PREAMP SWITCH Operation (p. 55)

Push to select one of two receive RF preamplifiers, or to bypass them.

- “P. AMP¹” is a wide dynamic range preamplifier. It is most effective for the 1.8 to 21 MHz bands.
- “P. AMP²” is a high-gain preamplifier. It is most effective for the 24 to 50 MHz bands.
- No indicator appears when the preamplifiers are not selected.

✓ What is the preamplifier?

The preamplifier amplifies signals in the front end to improve the S/N ratio and sensitivity. Select “P. AMP¹” or “P. AMP²” when receiving weak signals.

ATTENUATOR SWITCH Operation (p. 55)

- ➔ Hold down for 1 second to turn ON the attenuator.
 - “ATT” appears when the attenuator is ON.
- ➔ Push to turn OFF the attenuator.
 - “ATT” disappears.

✓ What is the attenuator?

The attenuator prevents a desired signal from being distorted when very strong signals are near it, or when very strong electromagnetic fields, such as from a broadcasting station, are near your location.

26 VOX/BK-IN SWITCH [VOX/BK-IN]

VOX SWITCH Operation (p. 62)

(Mode: SSB/AM/FM)

- ➔ Push to turn the VOX function ON or OFF.
- ➔ Hold down for 1 second to display the “VOX” screen. Push to return to the previous screen display.

✓ What is the VOX function?

The VOX function (voice operated transmission) automatically starts transmission when you speak into the microphone; then automatically returns to receive when you stop speaking.

BK-IN SWITCH Operation (p. 63)

(Mode: CW)

Push to toggle the Break-in function between semi break-in and full break-in, or to turn OFF the function.

✓ What is the Break-in function?

The Break-in function automatically switches between transmit and receive with your CW keying. Using the Full Break-in function (QSK), you can hear the receive frequency in-between keying.

27 COMPRESSOR SWITCH [COMP] (p. 64)

(Mode: SSB)

Push to turn the Speech Compressor function ON or OFF.

- “COMP” appears when this function is ON.

28 MONITOR SWITCH [MONITOR] (p. 65)

Push to turn the Monitor function ON or OFF to listen to your own transmitted audio.

- “MONI” appears when this function is ON.
- In the CW mode, the CW sidetone can be heard, regardless of the [MONITOR] switch setting.

29 SPEECH SWITCH [SPEECH] (p. 33)

- ➔ Push to audibly announce the S-meter level and the displayed frequency.
- ➔ Hold down for 1 second to audibly announce the S-meter level, the displayed frequency, and the operating mode.
 - The S-Level announcement can be turned OFF in the “SPEECH S-Level” item of the Set mode. (p. 87)
 - When RIT and/or ΔTX are ON, the RIT/ΔTX offset is not included in the frequency announcement.

30 FILTER SWITCH [FILTER] (p. 57)

- ➔ Push to select one of three IF filter settings (1/2/3).
 - The selected filter passband width and shifting value are displayed for 2 seconds on the LCD display.
- ➔ Hold down for 1 second to display the “FIL” screen (Filter) to set the filter passband width. Hold down for 1 second again to return to the previous screen display.

31 TUNING DIAL [DIAL] (p. 26)

Rotate to change the operating frequency, select the Set mode settings, etc.

32 LOCK SWITCH [LOCK] (p. 61)

Push to turn the Dial Lock function ON or OFF.

- This function electronically locks [DIAL].
- “LO” appears when this function is ON.

■ Front panel (continued)

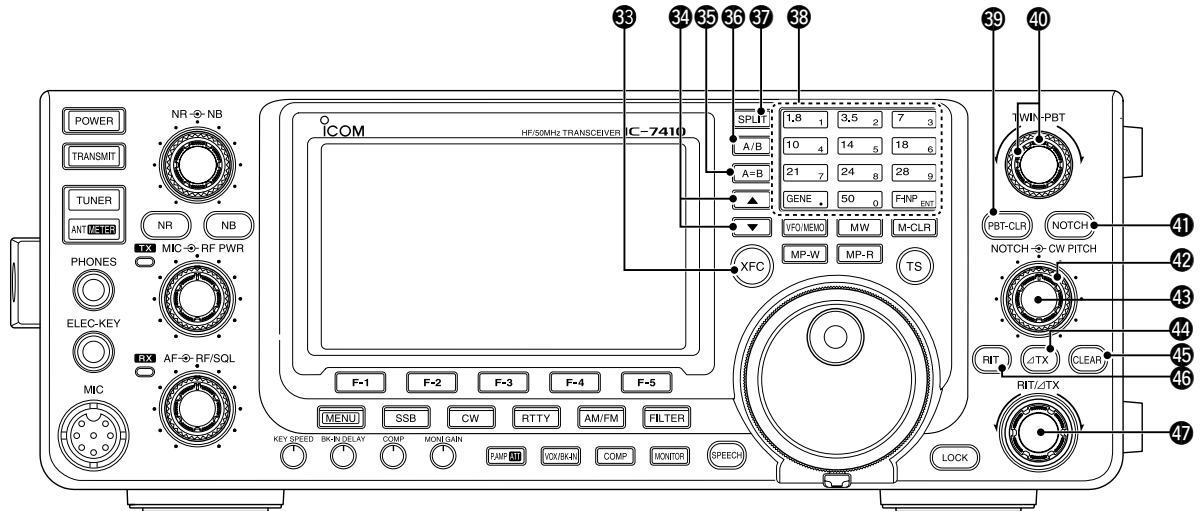

33 TRANSMIT FREQUENCY CHECK SWITCH [XFC]

- ➔ During split frequency or repeater operation, hold down to listen to the transmit frequency. (pp. 52, 56)
 - While holding down this switch, the transmit frequency can be changed with [DIAL], keypad or memo pad.
 - When the Split Lock function is turned ON, push [XFC] to cancel the Dial Lock function. (p. 67)
- ➔ When the RIT function is turned ON, hold down to listen to the displayed frequency (RIT is temporarily cancelled). (p. 53)
- ➔ When the ΔTX function is turned ON, hold down to listen to the transmit frequency (including ΔTX frequency offset). (p. 65)

34 UP/DOWN SWITCHES [▲]/[▼]

- ➔ Push to change the operating channel. (p. 69)
- ➔ Hold down to continuously change the operating channel.

35 VFO EQUALIZE SWITCH [A=B] (p. 24)

Hold down for 1 second to equalize frequencies of VFO A and B.

36 VFO SELECT SWITCH [A/B] (p. 24)

Push to select either VFO A or VFO B to display.

- “VFOA” or “VFOB” is displayed, depending on the selection.

37 SPLIT SWITCH [SPLIT]

- ➔ Push to turn the Split function ON or OFF. (p. 66)
 - “SPLIT” appears when the Split function is ON.
- ➔ Hold down for 1 second to activate the Quick Split function. (p. 67)
 - The transmit frequency shifts from the receive frequency according to the “FM SPLIT Offset HF/50” setting in the Set mode. (p. 86)
 - The Quick Split function can be turned OFF in the “Quick SPLIT” item of the Set mode. (p. 86)

38 BAND KEYS/KEYPAD

BAND KEYS Operation (p. 25)

- ➔ Push to select the operating band.
 - [GENE •] selects the general coverage band.
- ➔ Pushing the same key two or three times calls up other stacked frequencies in the frequency band.
 - Icom’s triple band stacking register memorizes three frequencies in each frequency band.

KEYPAD Operation (p. 26)

After pushing [F-INP ENT], push the keys on the keypad to enter a frequency. After entering, push [F-INP ENT] to set the frequency.

- Example; to enter 14.195 MHz:
Push [F-INP ENT] [1] [4] [•] [1] [9] [5] [F-INP ENT].

39 PBT CLEAR SWITCH [PBT-CLR] (p. 59)

(Mode: SSB/CW/RTTY/AM)

- ➔ Push to display the filter passband width and shifting value for 2 seconds on the function display.
- ➔ Hold down for 1 second to reset the PBT settings.

40 PASSBAND TUNING CONTROLS [TWIN-PBT]

(p. 59)

(Mode: SSB/CW/RTTY/AM)

Adjusts the receiver’s IF filter passband width using the DSP circuit.

- Rotate this control or push [PBT-CLR] to display the PBT settings (passband width and shifting value) for 1 second on the function display.
- Hold down [PBT-CLR] for 1 second to clear the PBT settings.
- The PBT is adjustable in 50 Hz steps in the SSB, CW and RTTY modes, and 200 Hz in the AM mode. In this time, the shift value changes in 25 Hz steps in the SSB, CW and RTTY modes, and 100 Hz in the AM mode.
- These controls function as an IF shift control.

✓ What is the PBT control?

The PBT function electronically modifies the IF passband width to reject interference. This transceiver uses the DSP circuit for the PBT function.

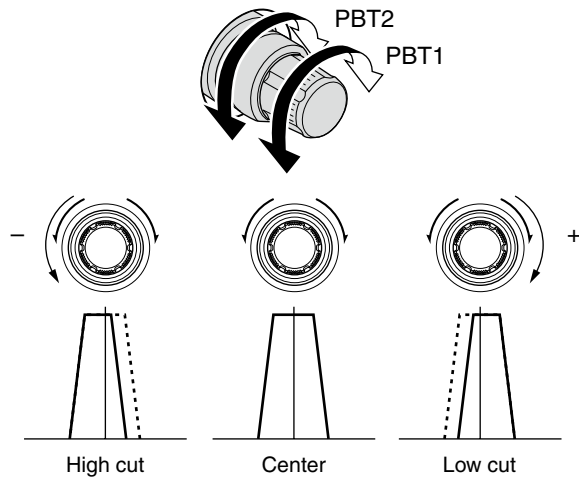

41 NOTCH SWITCH [NOTCH] (p. 61)

(Mode = Auto notch : SSB/AM/FM
Manual notch: SSB/CW/RTTY/AM)

- ➔ In the SSB and AM modes, push to toggle the notch function between auto, manual and OFF.
 - Either the Auto or Manual Notch function can be turned OFF in the “[NOTCH] SW” item of the Set mode. (p. 88)
- ➔ In the FM mode, push to turn the Auto Notch function ON or OFF.
- ➔ In the CW or RTTY mode, push to turn the Manual Notch function ON or OFF.
 - “MNF” appears when the Manual Notch function is ON.
 - “ANF” appears when the Auto Notch function is ON.
 - No icon appears when the Notch function is OFF.
- ➔ Hold down for 1 second to switch the manual filter characteristics from wide, mid and narrow when the Manual Notch function is selected.

✓ What is the notch filter?

The notch filter is a narrow filter that eliminates unwanted CW or AM carrier tones, while preserving the desired voice signal. The DSP circuit automatically adjusts the notch frequency to effectively eliminate unwanted tones.

42 MANUAL NOTCH FILTER CONTROL [NOTCH]

(inner control; p. 61)

Rotate to adjust the notch frequency to reject an interfering signal when the Manual Notch function is ON.

- Notch filter center frequency:
 - SSB/RTTY : -1040 Hz to +4040 Hz
 - CW : CW pitch freq. -2540 Hz to CW pitch freq. +2540 Hz
 - AM : -5060 Hz to +5100 Hz

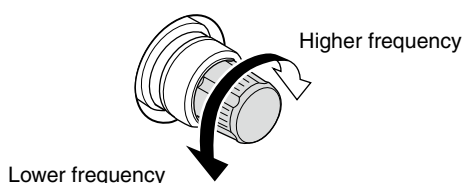

43 CW PITCH CONTROL [CW PITCH]

(outer control; p. 37)

Rotate to shift the received CW audio pitch and the CW sidetone pitch without changing the operating frequency.

- The pitch can be adjusted from 300 to 900 Hz in approximately 5 Hz steps.

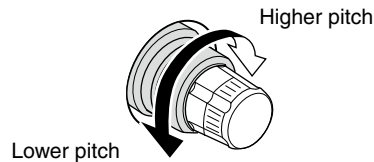

44 ΔTX SWITCH [ΔTX] (p. 65)

➔ Push to turn the ΔTX function ON or OFF.

- Use the [RIT/ΔTX] control to vary the ΔTX frequency.
- ➔ Hold down for 1 second to shift the transmit frequency up or down by the ΔTX frequency shift.

✓ What is the ΔTX function?

ΔTX shifts the transmit frequency without shifting the receive frequency. This is useful for simple split frequency operation in CW, etc.

45 CLEAR SWITCH [CLEAR] (pp. 53, 65)

Hold down for 1 second* to clear the RIT/ΔTX frequency shift.

- * When the “Quick RIT Clear” item in the Set mode is set to “ON,” push momentarily to reset the frequency shift. (p. 88)

46 RIT SWITCH [RIT] (p. 53)

➔ Push to turn the RIT function ON or OFF.

- Use [RIT/ΔTX] control to vary the RIT frequency.
- ➔ Hold down for 1 second to shift the receive frequency up or down by the RIT frequency shift.

✓ What is the RIT function?

The RIT (Receiver Incremental Tuning) shifts the receive frequency without shifting the transmit frequency.

This is useful for fine tuning stations calling you off-frequency or when you prefer to listen to slightly different-sounding voice characteristics, etc.

47 RIT/ΔTX CONTROL [RIT/ΔTX] (pp. 53, 65)

When either or both the RIT/ΔTX functions are ON, rotate to adjust the RIT/ΔTX frequency shift.

- Rotate the control clockwise to increase the frequency, or counterclockwise to decrease the frequency.
- The frequency shift range is ±9.999 kHz in 10 Hz steps. The control tunes in 1 Hz steps when the operating frequency readout is set to the 1 Hz step readout.

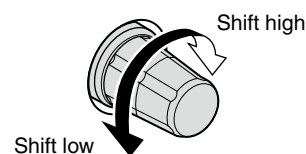

1 PANEL DESCRIPTION

■ Front panel (continued)

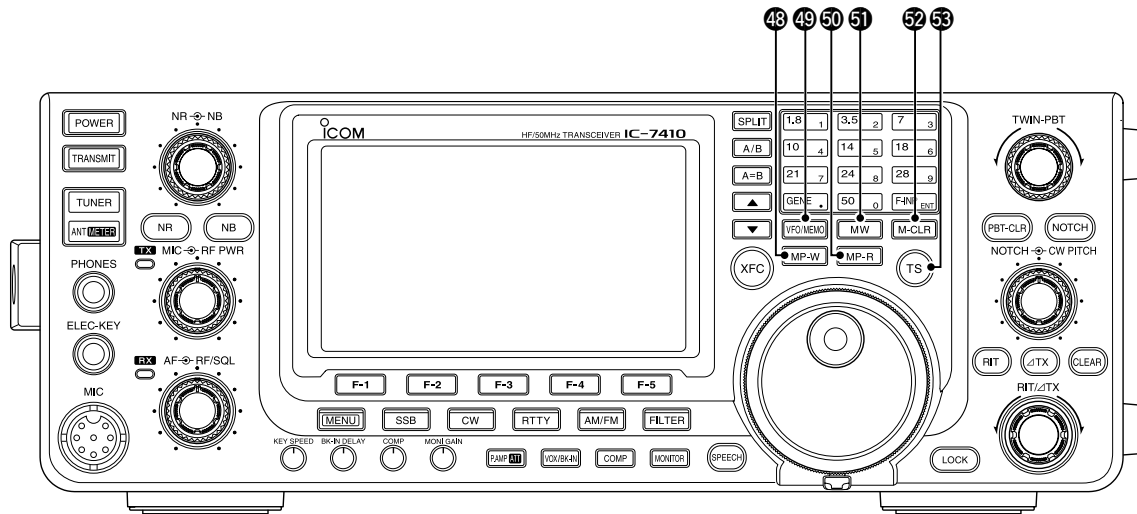

48 MEMO PAD-WRITE SWITCH [MP-W] (p. 74)

- ➔ Push to write the displayed data into a memo pad.
- The five most recent entries remain in the memo pads.
- The memo pad capacity can be extended from 5 to 10 in the “Memopad Numbers” item in the Set mode. (p. 87)

49 VFO/MEMORY SWITCH [VFO/MEMO]

- ➔ Push to switch between the VFO and Memory modes. (p. 24)
- ➔ Hold down for 1 second to transfer the memory contents to the displayed VFO. (p. 72)

50 MEMO PAD-READ SWITCH [MP-R] (p. 74)

- ➔ Push to sequentially call up the contents from the memo pads.
- The 5 (or 10) most recently programmed frequencies and operating modes can be recalled, starting from the most recent.
- The memo pad capacity can be extended from 5 to 10 in the “Memopad Numbers” item in the Set mode. (p. 87)

51 MEMORY WRITE SWITCH [MW] (p. 70)

- ➔ Hold down for 1 second to store VFO data into the selected memory channel.
- This can be done in both the VFO and memory modes.

52 MEMORY CLEAR SWITCH [M-CLR] (p. 71)

- ➔ In the Memory mode, hold down for 1 second to clear the memory channel.
- The channel becomes a blank channel.
- This switch is disabled in the VFO mode.

53 TUNING STEP SWITCH [TS] (p. 27)

- ➔ Push to turn quick tuning step ON or OFF.
- When the “▼” quick tuning icon is displayed above the kHz digit, the frequency is changed in selected quick tuning steps.
- When the quick tuning is OFF, the frequency is changed in 10 Hz steps.
- ➔ When the quick tuning is ON, hold down for 1 second to display the “TS” screen (Tuning Step) to select the quick tuning step.
- 0.1, 1, 5, 9, 10, 12.5, 20, and 25 kHz steps are independently selectable for each operating mode.
- ➔ When the quick tuning is OFF, hold down for 1 second to turn the minimum tuning step of 1 Hz ON or OFF.

■ Rear panel

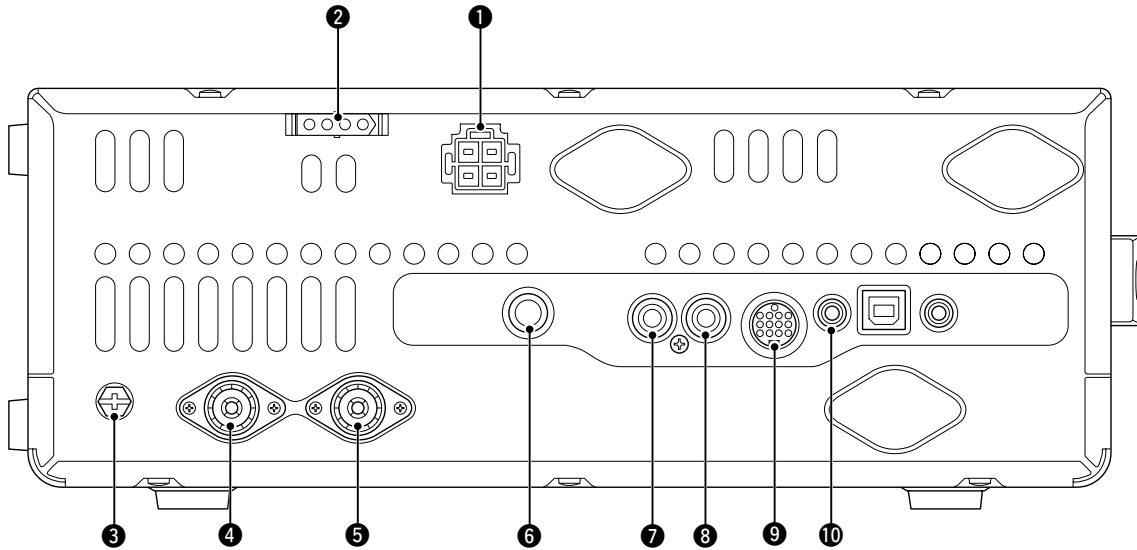

- 1 DC POWER SOCKET [DC 13.8V]** (p. 19)
Connect 13.8 V DC through the supplied DC power cable.

Rear panel view

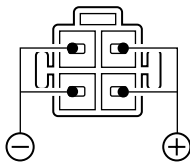

- 2 TUNER CONTROL SOCKET [TUNER]** (p. 18)
Connect the control cable from an optional AH-4 HF/ 50 MHz AUTOMATIC ANTENNA TUNER.
- 3 GROUND TERMINAL [GND]** (p. 15)
Connect this terminal to a ground to prevent electrical shocks, TVI, BCI and other problems.
- 4 ANTENNA CONNECTOR 1 [ANT1]** (p. 16)
- 5 ANTENNA CONNECTOR 2 [ANT2]** (p. 16)
Connect a 50 Ω antenna with a PL-259 plug connector.

When using an optional AH-4 HF/ 50 MHz AUTOMATIC ANTENNA TUNER, connect it to the [ANT1] connector. Connecting the AH-4 activates the internal antenna tuner for [ANT2] and deactivates it for [ANT1].

- 6 STRAIGHT KEY JACK [KEY]** (p. 16)
Connect a straight key or external electronic keyer output using a standard 1/4 inch plug.
• To use the internal electronic keyer for CW operation, connect to [ELEC-KEY] on the front panel. (p. 1)

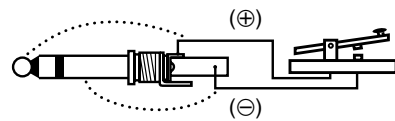

- 7 ALC INPUT JACK [ALC]** (p. 21)
When transmitting, goes to ground to control an external unit, such as a non-Icom linear amplifier.
- 8 SEND CONTROL JACK [SEND]** (p. 21)
Connect a ground when transmitting to control an external unit, such as a non-Icom linear amplifier.
- 9 ACCESSORY SOCKET [ACC]**
Connect control lines for external equipment such as a linear amplifier, an automatic antenna selector/tuner, a TNC for data communications, etc.
• See page 10 for socket information.

- 10 CI-V REMOTE CONTROL JACK [REMOTE]** (p. 17)
 - Connect a PC, using the optional CT-17 CI-V LEVEL CONVERTER, for external control of the transceiver.
 - Use for transceive operation with another Icom CI-V transceiver or receiver. When the transceive function is set to ON, changing the frequency, operating mode, etc. on the IC-7410 automatically changes those settings on other Icom transceivers or receivers, and vice versa. (p. 89)

1 PANEL DESCRIPTION

■ Rear panel (Continued)

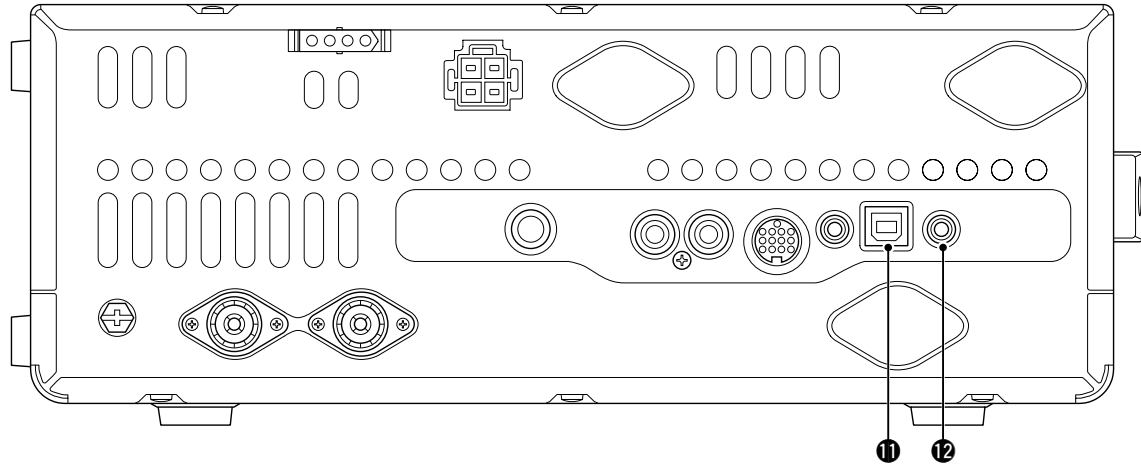

11 USB (Universal Serial Bus) CONNECTOR [USB]

Using a USB cable, connect a PC to do the following:

- Input modulation (p. 89)
- Remotely control the transceiver using CI-V commands (p. 101)
- Send the received audio to the PC
- Send the decoded characters to the PC (p. 89)

About the USB driver:

The USB driver and the installation guide can be downloaded from our website.

➔ <http://www.icom.co.jp/world/index.html>

The following items are required:

PC

- Microsoft® Windows® XP, Microsoft® Windows Vista® or Microsoft® Windows® 7 OS
- A USB 1.1 or 2.0 port

Other items

- USB cable (purchase separately)
- PC software (such as optional RS-BA1)

NOTE: BE SURE to install the USB driver **BEFORE** connecting the USB cable between the radio and the PC. This is because the USB driver does not support the automatic recognition system.

About the modulation input:

Select "USB" in the Set mode item "DATA OFF MOD" or "DATA MOD." The modulation input level from the USB jack can be set in the Set mode item "USB MOD Level." (p. 89)

12 EXTERNAL SPEAKER JACK [EXT-SP] (p. 17)

Connect an external speaker (4 to 8 Ω).

◇ ACC socket information

• ACC socket

ACC	PIN No.	NAME	DESCRIPTION	SPECIFICATIONS	
 <p>Rear panel view</p> <p>① brown ⑧ gray ② red ⑨ white ③ orange ⑩ black ④ yellow ⑪ pink ⑤ green ⑫ light blue ⑥ blue ⑬ light green ⑦ purple</p> <p>Color refers to the cable strands of the supplied cable.</p>	1	8 V	Regulated 8 V output.	Output voltage : 8 V ± 0.3 V Output current : Less than 10 mA	
	2	GND	Connects to ground.	—	
	3	SEND*	Input/output pin.	An external unit controls the transceiver. When this pin goes low, the transceiver transmits. The transceiver outputs a low signal to control an external unit.	Input voltage (High) : 2.0 V to 20.0 V Input voltage (Low) : -0.5 V to +0.8 V Current flow : Max. 20 mA Output voltage (Low) : Less than 0.1 V Current flow : Max. 200 mA
	4	NC	—	—	
	5	BAND	Band voltage output.	Output voltage : 0 V to 8 V	
	6	ALC	ALC voltage input.	Control voltage : -3 V to 0 V Input impedance : More than 3.3 kΩ	
	7	NC	—	—	
	8	13.8 V	13.8 V output when power is ON.	Output current : Less than 1 A	
	9	NC	—	—	
	10	FSKK	Controls RTTY keying	“High” level : More than 2.4 V “Low” level : Less than 0.6 V Output current : Less than 2 mA	
	11	MOD	Modulator input.	Input impedance : 10 kΩ Input level : Approx. 100 mV rms	
	12	AF	AF detector output. Fixed level, regardless of the [AF] control position.	Output impedance : 4.7 kΩ Output level : 100 to 300 mV rms	
	13	SQL S	Squelch output. Grounded when squelch opens.	SQL open : Less than 0.3 V/5 mA SQL closed : More than 6.0 V/100 μA	

* When the SEND terminal controls an inductive load (such as a relay), a counter-electromotive force can cause the transceiver’s malfunction or damage. To prevent this, we recommend adding a switching diode, such as an “1SS133,” on the load side of the circuit to the counter-electromotive force absorption. When the diode is added, a switching delay of the relay may occur. Be sure to check its switching action before operation.

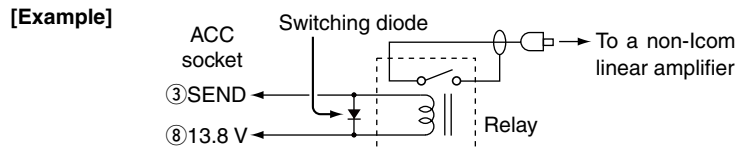

• When connecting the ACC conversion cable (OPC-599)

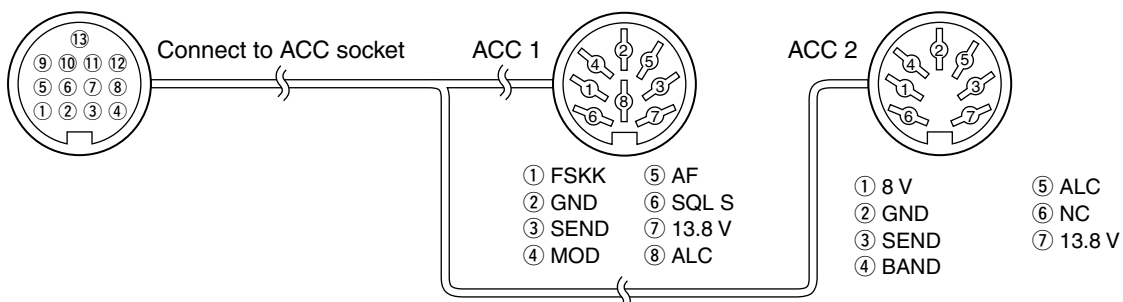

■ LCD display

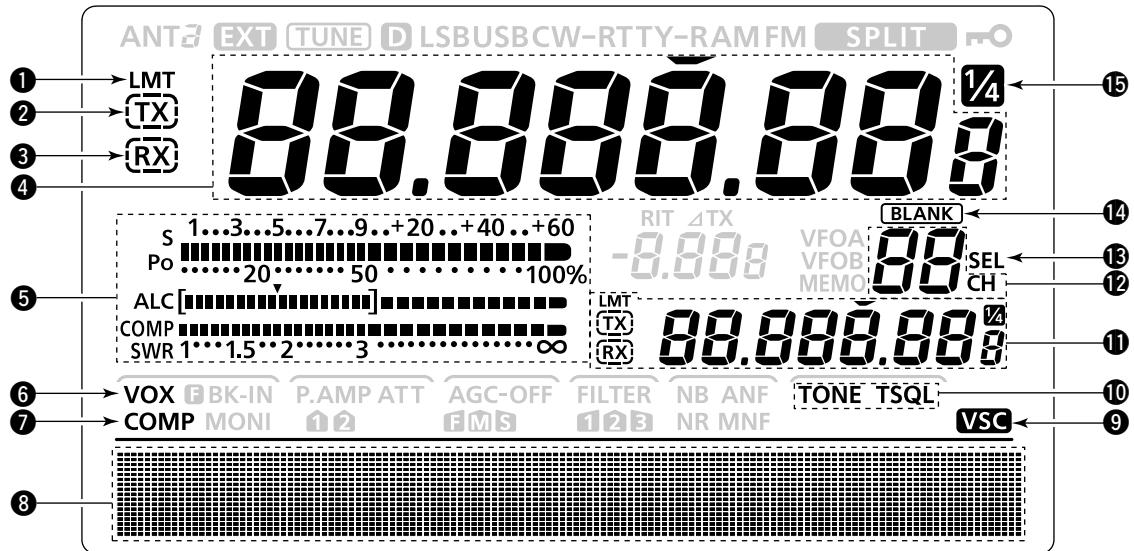

1 POWER DOWN TRANSMISSION ICON (p. 98)

Appears when the output power is decreased by the Reduced Power Transmission function.

2 TX ICON

Indicates the transmit frequency is displayed.

- “TX” appears while the operating frequency is in an amateur band.
- “TX” appears while the operating frequency is not in an amateur band. However, when the “Band Edge Beep” item is set to “OFF” in the Set mode (p. 85), “TX” does not appear.

3 RX ICON

Indicates the receive frequency is displayed.

4 FREQUENCY READOUT

- Displays the operating frequency.
 - When the quick tuning icon “▼” is displayed, the frequency changes in kHz quick tuning steps. (p. 27)
 - When the quick tuning icon “▼” is not displayed, the frequency changes in 10 Hz or 1 Hz steps.
- When the Split function is ON, displays the receive frequency (VFO A or VFO B). (p. 66)

5 MULTI-FUNCTION METER INDICATION

- Displays the signal strength while receiving.
- Displays the relative output power, ALC and SWR or compression levels while transmitting. (p. 33)
- When the Meter Peak Hold function is ON, the peak level of a received signal strength or the output power is displayed for approximately 0.5 seconds. (p. 60)

6 VOX ICON (p. 62)

Appears when the VOX function is ON.

7 SPEECH COMPRESSOR ICON (p. 64)

Appears when the Speech Compressor function is ON.

8 FUNCTION DISPLAY (pp. 13, 14)

Shows the function of the function switches ([F-1] to [F-5]), Set mode items and IF passband width.

9 VOICE SQUELCH CONTROL ICON (p. 76)

Appears when the VSC (Voice Squelch Control) function is ON.

10 TONE SQUELCH ICONS
(Mode: FM)

- “TONE” appears when the Repeater Tone function is ON. (p. 52)
- “TSQ” appears when the Tone Squelch function is ON. (p. 50)

11 SPLIT READOUT (pp. 66, 67)

When the Split function is ON, displays the transmit frequency (VFO A or VFO B).

12 MEMORY CHANNEL READOUT (p. 69)

Displays the selected memory channel.

13 SELECT MEMORY CHANNEL ICON (p. 80)

Appears when the selected memory channel is set as a select memory channel.

14 BLANK MEMORY ICON (pp. 69, 71)

Appears when the selected memory channel is blank.

15 1/4 TUNING DIAL SPEED ICON (p. 27)
(Mode: SSB-D/CW/RTTY)

Appears when the tuning dial speed is set so that one rotation is equal to 1/4 of the normal rotation.

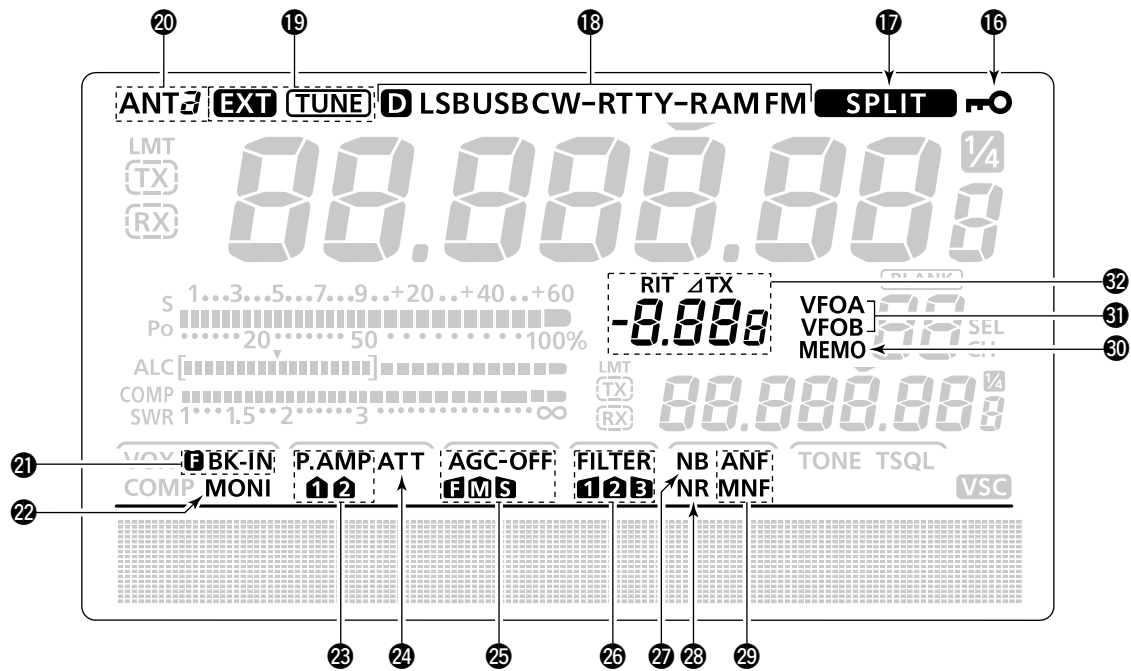

- 16 DIAL LOCK ICON** (p. 61)
Appears when the Dial Lock function is ON.
- 17 SPLIT ICON** (p. 66)
Appears when the Split function is ON.
- 18 MODE ICONS** (p. 31)
Displays the selected operating mode.
 - “D” appears when the SSB data, AM data or FM data mode is selected.
- 19 ANTENNA TUNER ICONS** (p. 83)
 - ➔ “TUNE” appears when the antenna tuner is ON; “TUNE” blinks during tuning.
 - ➔ “EXT” appears when the optional AH-4 external antenna tuner is connected to the [ANT1] connector, and [ANT1] is selected.
- 20 ANTENNA ICONS** (p. 82)
Displays which antenna connector is selected for HF/50 MHz.
 - “ANT1” appears when the [ANT1] connector is selected.
 - “ANT2” appears when the [ANT2] connector is selected.
- 21 BREAK-IN ICONS** (p. 63)
 - ➔ “F BK-IN” appears when the Full Break-in function is ON.
 - ➔ “BK-IN” appears when the Semi Break-in function is ON.
- 22 MONITOR ICON** (p. 65)
Appears when the Monitor function is ON.
- 23 PREAMP ICONS** (p. 55)
Appears when a preamplifier is ON.
 - “P. AMP 1” for preamp 1; “P. AMP 2” for preamp 2.
- 24 ATTENUATOR ICON** (p. 55)
Appears when the Attenuator is ON.
- 25 AGC ICONS** (p. 56)
Displays the selected AGC time constant.
 - “F” for fast AGC; “M” for mid AGC; “S” for slow AGC; “-OFF” for AGC OFF.
- 26 DSP FILTER ICONS** (p. 57)
Displays the selected IF filter.
- 27 NOISE BLANKER ICON** (p. 60)
Appears when the Noise Blanker is ON.
- 28 NOISE REDUCTION ICON** (p. 61)
Appears when the Noise Reduction is ON.
- 29 NOTCH ICONS** (p. 61)
 - (Mode: SSB/CW/RTTY/AM)
 - ➔ “MNF” appears when the Manual Notch function is ON.
 - (Mode: SSB/AM/FM)
 - ➔ “ANF” appears when the Automatic Notch function is ON.
- 30 MEMORY ICON** (p. 24)
Appears when the memory mode is selected.
- 31 VFO ICONS** (p. 24)
Appears when VFO A or VFO B is selected.
- 32 RIT/ΔTX ICONS** (pp. 53, 65)
 - ➔ “RIT” appears when the RIT function is ON.
 - ➔ “ΔTX” appears when the ΔTX function is ON.
 - ➔ Shows the frequency shift of the RIT or ΔTX function.

■ Function display

Push [MENU] to toggle between M1 (Menu 1) and M2 (Menu 2).

- The set of functions assigned to the function switches changes, according to the selected menu and operating mode.

◇ M1 (Menu 1)

(Mode: SSB)

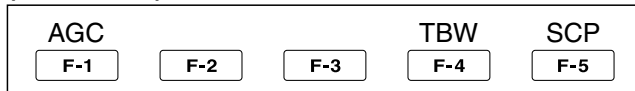

(Mode: SSB-D)

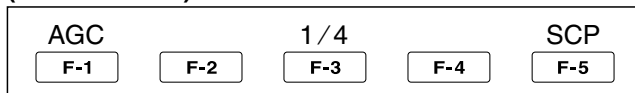

(Mode: CW)

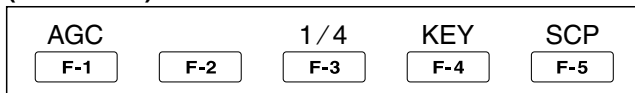

(Mode: RTTY)

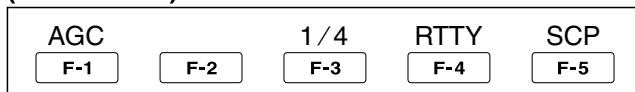

(Mode: AM)

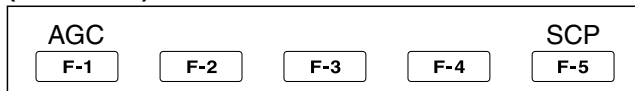

(Mode: FM)

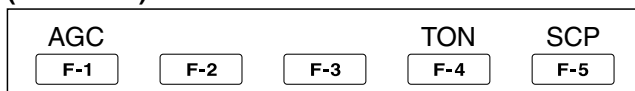

Push to select the functions displayed above switches ([F-1] to [F-5]).

- Functions vary, depending on the operating mode.

◇ Function keys on M1 (Menu 1)

AGC KEY [AGC](F-1) (p. 56)

(Mode: SSB/CW/RTTY/AM/FM)

- ➔ Push to select the time constant of the AGC circuit.
- ➔ Hold down for 1 second to display the “AGC” screen.

1/4 TUNING FUNCTION KEY [1/4](F-3) (p. 27)

(Mode: SSB-D/CW/RTTY)

Push to turn the 1/4 Tuning function ON or OFF.

- “” is displayed when the 1/4 Tuning function is ON.

TRANSMISSION BANDWIDTH KEY [TBW](F-4)

(p. 64)

(Mode: SSB)

- ➔ Push to display the selected transmission bandwidth.
- ➔ Hold down for 1 second to select the transmission bandwidth.
 - Wide (WIDE), mid (MID) and narrow (NAR) bandwidths are selectable.

MEMORY KEYS MENU KEY [KEY](F-4) (p. 38)

(Mode: CW)

Push to display the “KEY” screen (Memory Keyer) or the “SEND” screen (Keyer Send), depending on the “KEYER 1st Menu” setting in the Set mode (p. 88).

RTTY MENU KEY [RTTY](F-4) (p. 45)

(Mode: RTTY)

Push to display the “RTTY” screen.

STONE SQUELCH KEY [TON](F-4) (p. 50)

(Mode: FM)

- ➔ Push to select a tone function between subaudible (repeater) tone and tone squelch.
- ➔ Hold down for 1 second to display the “TON” screen (Tone) of the selected tone function.

BAND SCOPE FUNCTION KEY [SCP](F-5) (p. 54)

(Mode: SSB/CW/RTTY/AM/FM)

Push to display the “SCP” screen (Band Scope).

◇ M2 (Menu 2)

SCAN F-1	MEM F-2	SWR F-3	TCON F-4	VSC F-5
-------------	------------	------------	-------------	------------

◇ Function keys on M2 (Menu 2)**SCAN KEY [SCAN](F-1)** (p. 75)**(Mode: SSB/CW/RTTY/AM/FM)**

Push to display the "SCAN" screen.

MEMORY NAME KEY [MEM](F-2) (p. 73)**(Mode: SSB/CW/RTTY/AM/FM)**

Push to display the "MEM" screen (Memory Name Edit).

SWR GRAPH FUNCTION KEY [SWR](F-3) (p. 68)**(Mode: SSB/CW/RTTY/AM/FM)**

Push to display the "SWR" screen.

TONE CONTROL SET MODE KEY [TCON](F-4)

(p. 90)

(Mode: SSB/CW/RTTY/AM/FM)

Push to enter the Tone Control Set mode.

VSC FUNCTION KEY [VSC](F-5) (p. 76)**(Mode: SSB/AM/FM)**

Push to turn the VSC function (Voice Squelch Control) ON or OFF.

- "**VSC**" appears when the VSC function is ON.

■ Selecting a location

Select a location for the transceiver that allows adequate air circulation, free from extreme heat, cold, or vibrations, and away from TV sets, TV antenna elements, radios and other electromagnetic sources.

The base of the transceiver has adjustable feet for desktop use. Set the feet to one of two angles, to meet your operating preference.

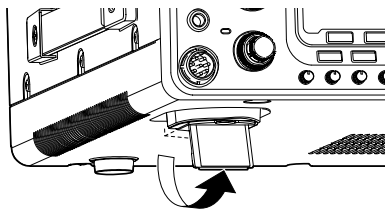

■ Grounding

To prevent electrical shock, television interference (TVI), broadcast interference (BCI) and other problems, ground the transceiver using the GROUND terminal on the rear panel.

For best results, connect the heaviest possible gauge wire or strap to a long ground rod. Make the distance between the [GND] terminal and ground as short as possible.

WARNING! NEVER connect the [GND] terminal to a gas or electric pipe, since the connection could cause an explosion or electric shock.

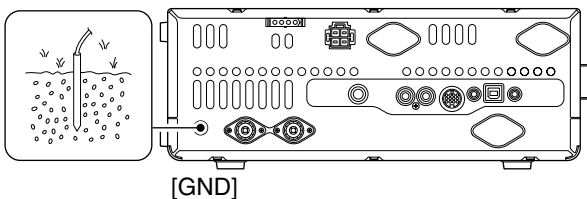

■ Antenna connection

For radio communications, the antenna is of critical importance, along with output power and receiver sensitivity. Select a well-matched 50 Ω antenna and coaxial cable feedline. We recommend 1.5:1 or better of Voltage Standing Wave Ratio (VSWR) on your operating bands. The transmission line should be a coaxial cable.

When using a single antenna, use the [ANT1] connector.

CAUTION: Protect your transceiver from lightning by using a lightning arrester.

Antenna SWR

Each antenna is tuned for a specified frequency range and the SWR usually increases outside the range. When the SWR is higher than approx. 2.0:1, the transceiver automatically reduces the TX power to protect the final transistors. In that case, an antenna tuner is useful to match the transceiver and antenna. Low SWR allows full power for transmitting. The IC-7410 has an SWR meter to continuously monitor the antenna SWR.

PL-259 CONNECTOR INSTALLATION EXAMPLE

- ① Slide the coupling ring down. Strip the cable jacket and tin the shield.
- ② Strip the cable as shown at left. Tin the center conductor.
- ③ Slide the connector body on and solder it.
- ④ Screw the coupling ring onto the connector body.

30 mm (1.18 in) 10 mm (0.39 in) 1–2 mm (0.04–0.08 in)

Required connections

Front panel

ELEC-KEY

A straight key can be connected. However, "Straight key" must be selected in the "Keyer Type" item of the Keyer Set mode. (p. 43)

MICROPHONES (p. 22)

HM-36

SM-50
(option)

SM-30
(option)

Rear panel

DC POWER SUPPLY (p. 19)

PS-126

HF/50MHz ANTENNA 1, 2 (p. 15)

Connection example:
[ANT 1] for 1.8–18 MHz bands antenna
[ANT 2] for 21–28 MHz bands antenna

GROUND (p. 15)

Use the heaviest possible gauge wire or strap and make the connection as short as possible.

Grounding prevents electrical shocks, TVI and other problems.

STRAIGHT KEY

Advanced connections

Front panel

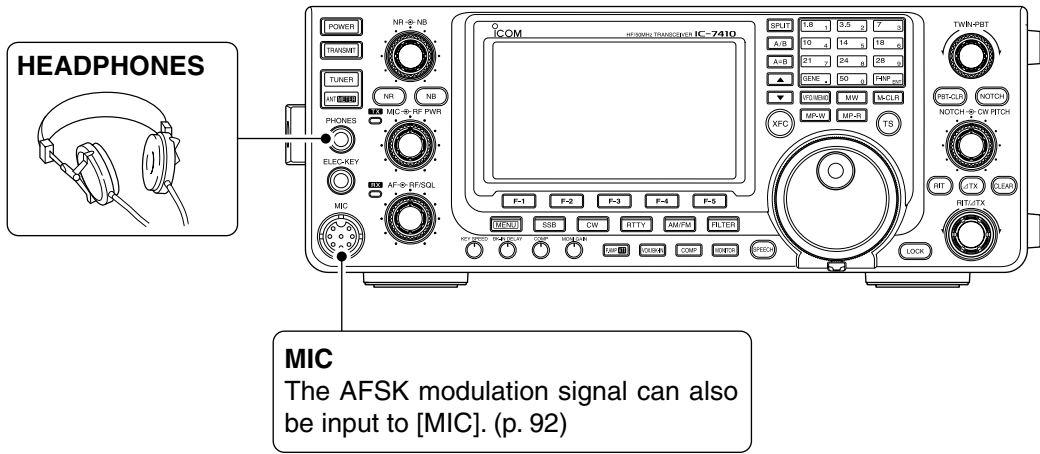

Rear panel

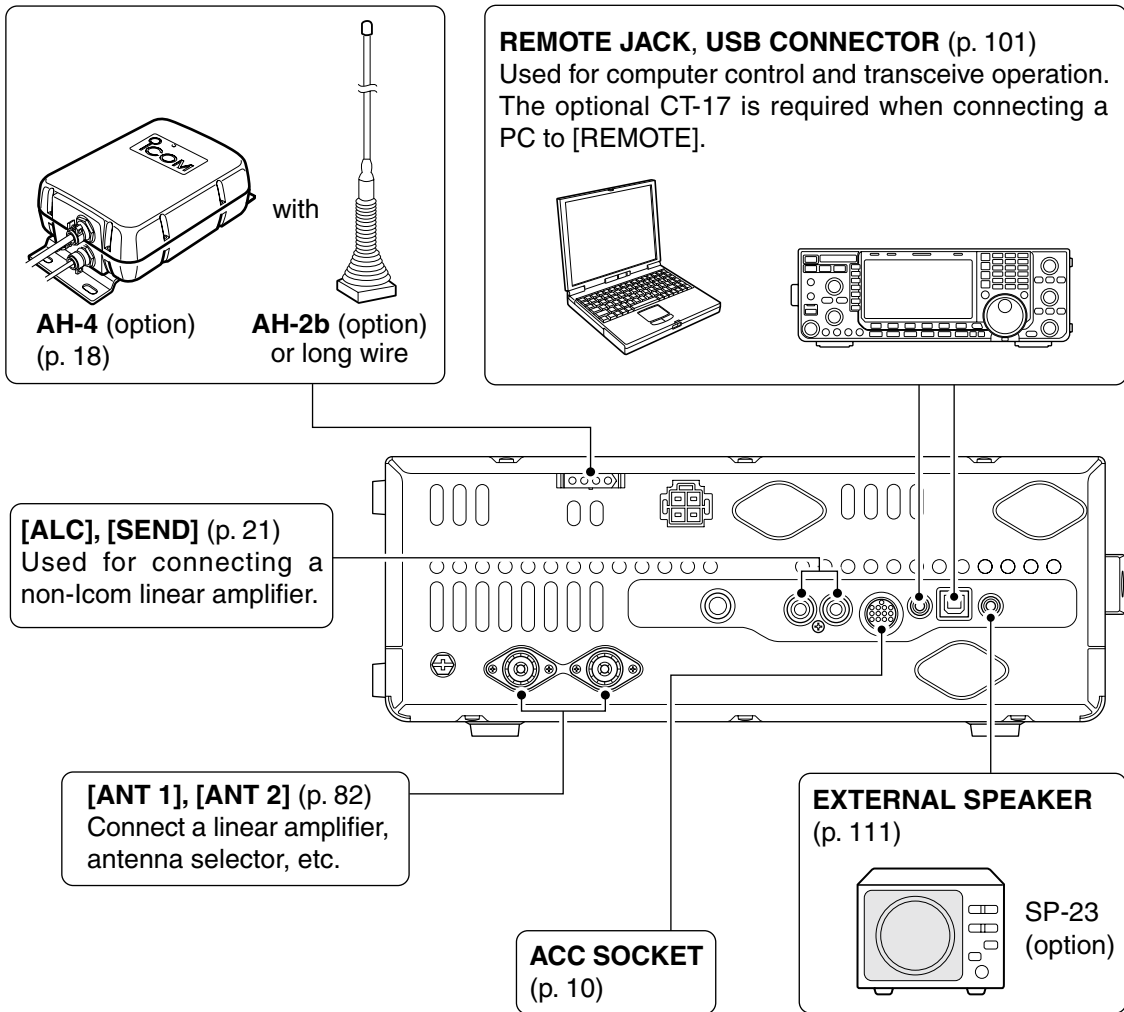

External keypad connections

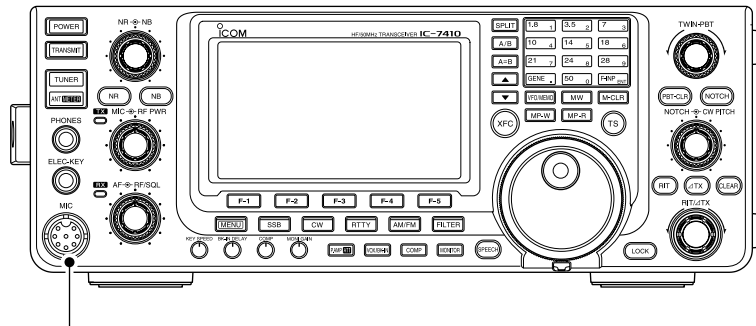

EXTERNAL KEYPAD

Connect an external keypad for keyer memory control.

When using a external keypad, set the "External Keypad" item to "KEYER SEND" in the Set mode. (p. 88)

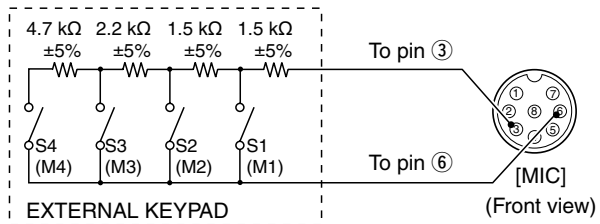

2

External antenna tuner connection

◇ Connecting the AH-4

/// The AH-4 must be connected to [ANT1].

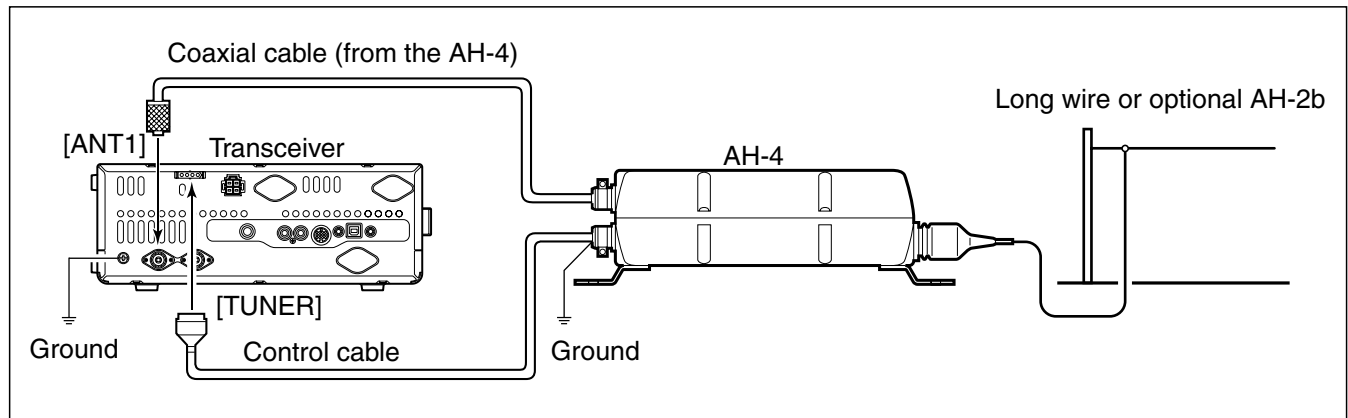

■ Power supply connections

When operating the transceiver with AC power, use a power supply with 13.8 V DC output and a capacity of at least 23 Amps.

Refer to the diagrams below.

CAUTION: Before connecting the DC power cable, check the following important items.

Make sure:

- The [POWER] switch is OFF.
- Output voltage of the power source is 12–15 V when you use a non-Icom power supply.
- DC power cable polarity is correct.
 Red : Positive ⊕ terminal
 Black : Negative ⊖ terminal

■ Connecting to a DC power supply

◇ Connecting to the PS-126 DC POWER SUPPLY

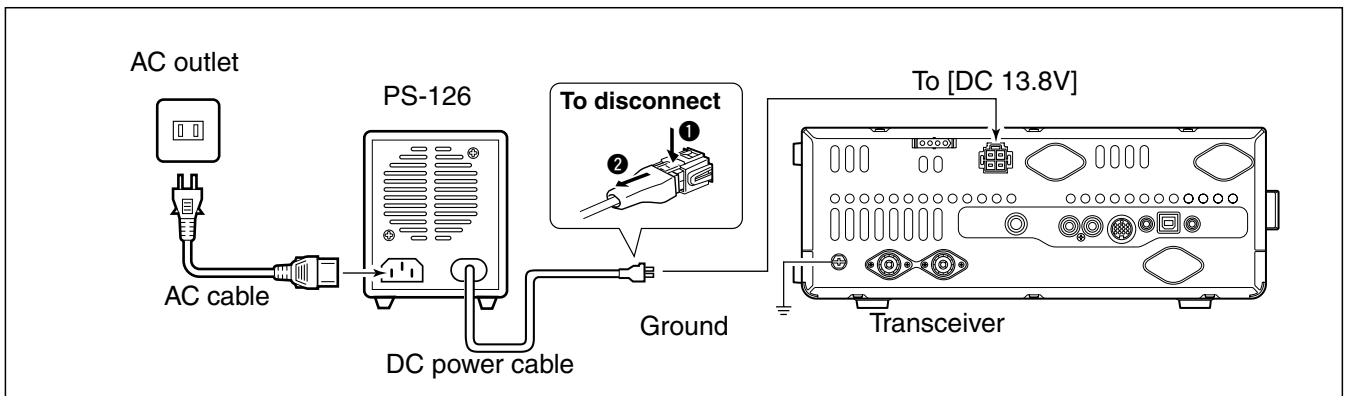

◇ Connecting to a non-Icom DC POWER SUPPLY

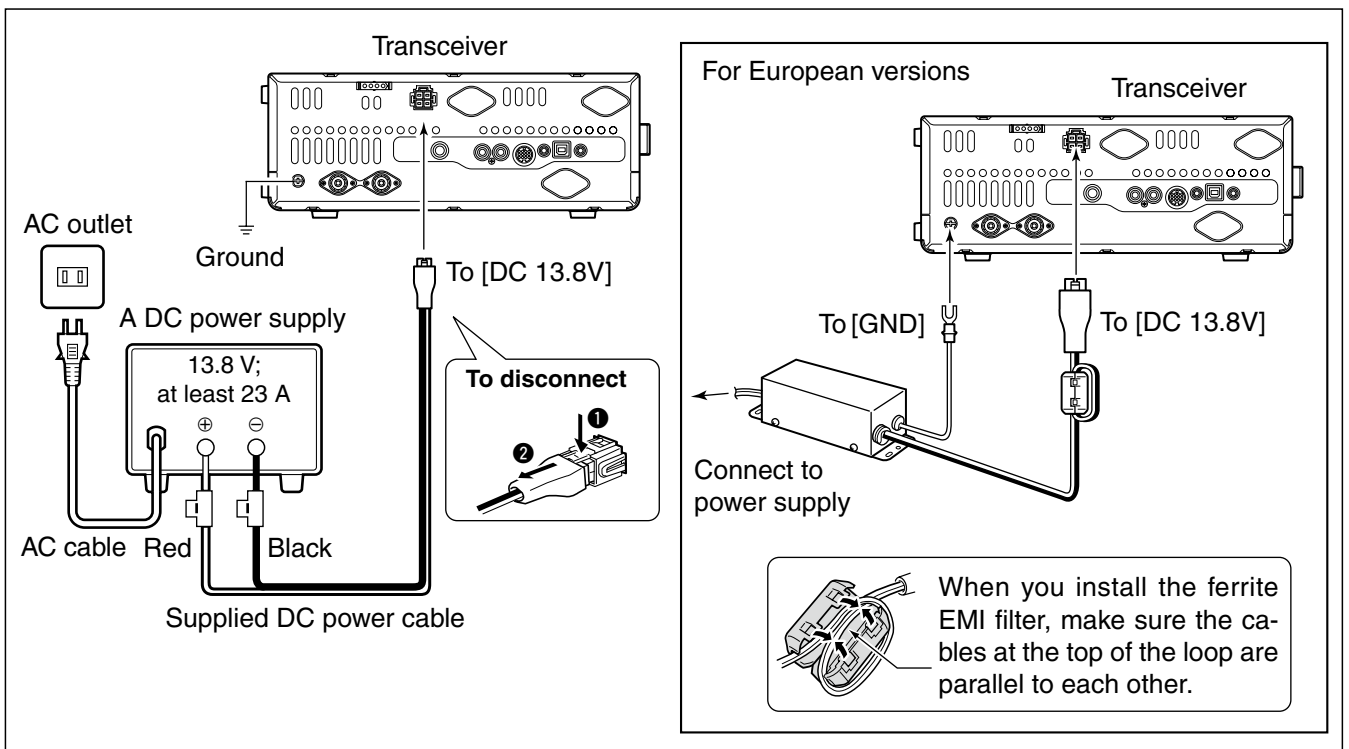

■ Linear amplifier connections

◇ Connecting the IC-PW1/PW1EURO

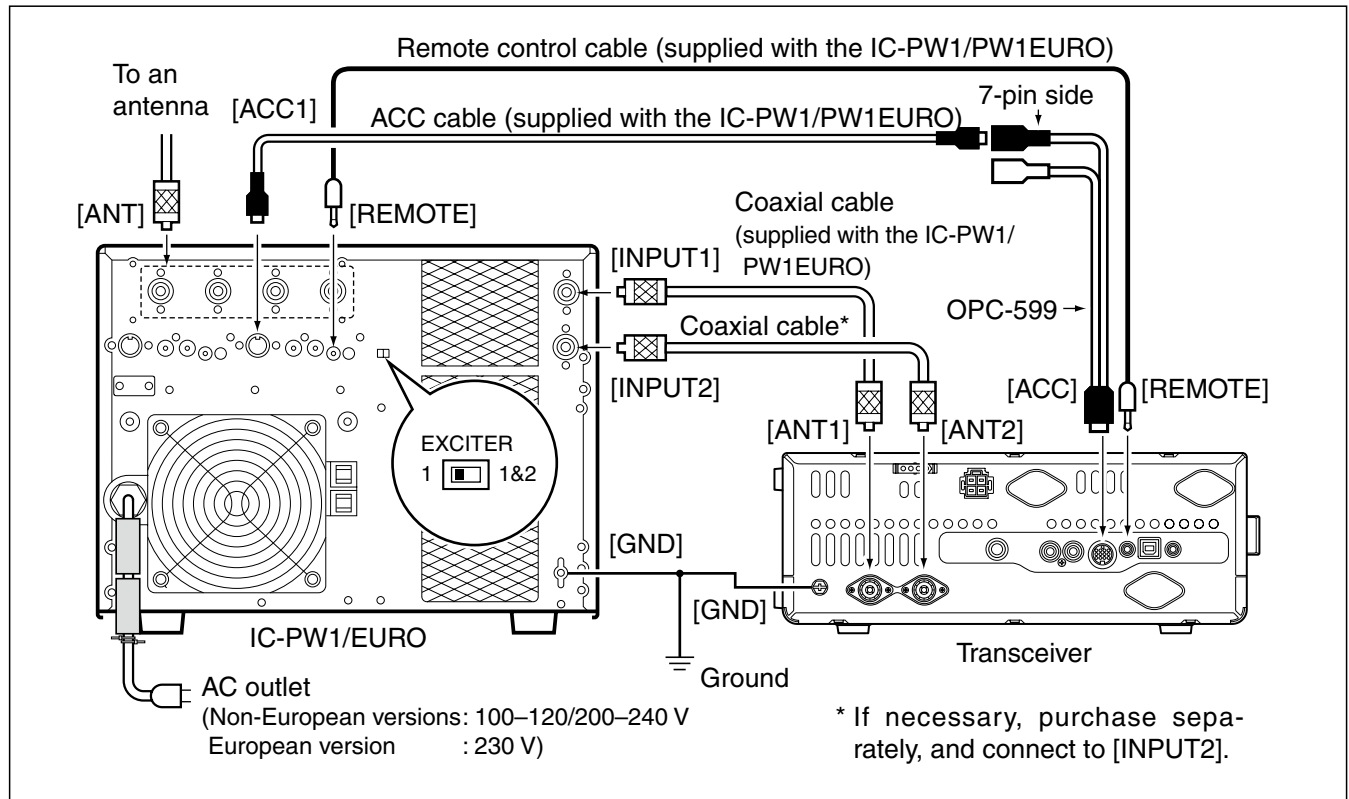

2

■ Linear amplifier connections (Continued)

◇ Connecting a non-Icom linear amplifier

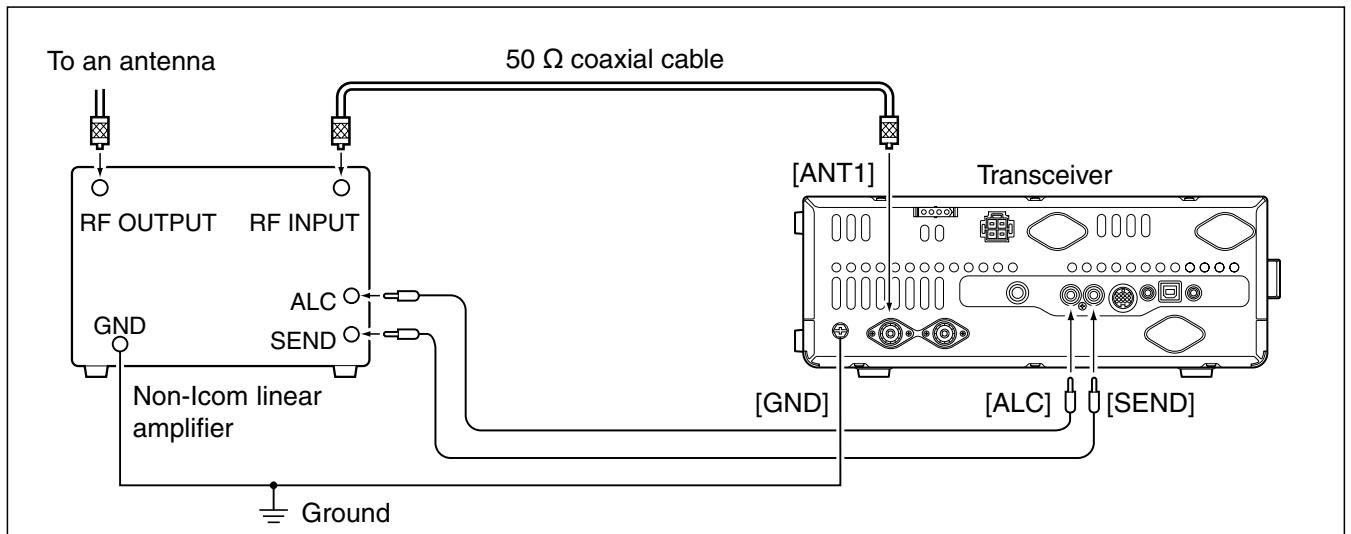

⚠ **WARNING!**

- Set the transceiver output power and linear amplifier ALC output level after referring to the linear amplifier instruction manual.
- The ALC input level must be in the range 0 V to -3 V. The transceiver does not accept a positive voltage. Non-matched ALC and RF power settings could overheat or damage the linear amplifier.
- The IC-7410 SEND terminal (ACC connector pin 3) is rated at 16 V/0.5 A DC. If this value is exceeded, a larger external relay must be used.

Microphone connector information

(Front panel view)

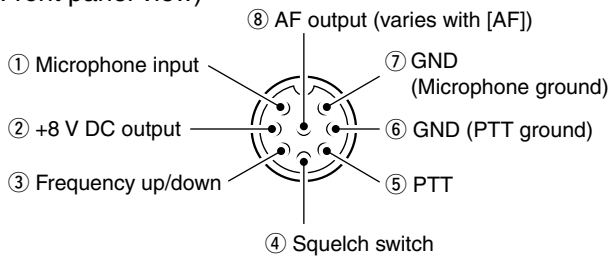

[MIC] Pin No.	FUNCTION	DESCRIPTION
②	+8 V DC output	Max. 10 mA
③	Frequency up	Ground
	Frequency down	Ground through 470 Ω
④	Squelch open	“Low” level
	Squelch closed	“High” level

CAUTION: DO NOT short pin 2 to ground as this can damage the internal 8 V regulator. A DC voltage is applied to pin 1 for microphone operation. Use caution when using a non-Icom microphone.

Microphones

◇ HM-36

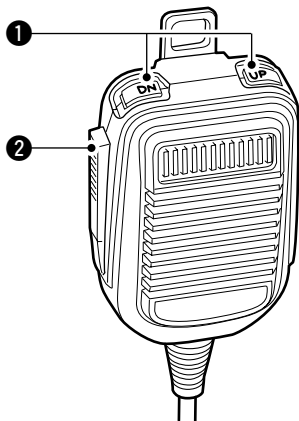

① UP/DOWN SWITCHES [UP]/[DN]

- Push to change the frequency or memory channel.
- While holding down, the frequency or memory channel number continuously increases or decreases.
 - While in the split frequency mode, and holding down [XFC], push to change the transmit frequency.
 - The [UP]/[DN] switch can be used as a key paddle if the “MIC Up/Down Keyer” item is set to “ON” in the Keyer Set mode. In such case, the frequency and memory channel cannot be changed using the [UP]/[DN] switches. (p. 43)
 - You can set the dot-dash polarity of the [UP]/[DN] switch in the “Paddle Polarity” item in the Keyer Set mode. When “Normal” is selected, [UP] sends a dash, and [DN] sends a dot.

◇ SM-50 (option)

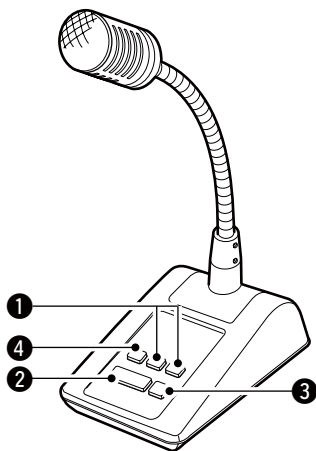

② PTT SWITCH

Hold down to transmit; release to receive.

③ PTT LOCK SWITCH (available on only the SM-50)

Push to toggle between transmit and receive.

④ LOW CUT SWITCH (available on only the SM-50)

Push to cut out the low frequency components of input voice signals.

■ Before first applying power

Before turning ON your transceiver for the first time, make sure all connections required for your system are complete by reviewing them in Section 2 of this manual.

After all connections have been made, set controls and switches as shown in the illustration below.

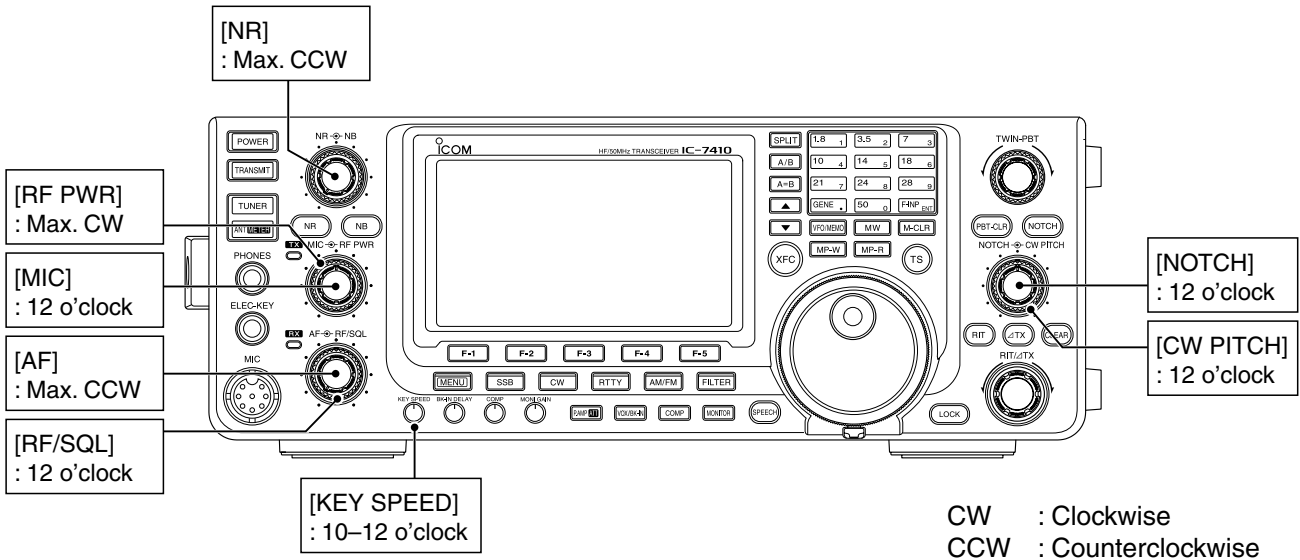

■ Turning ON (CPU resetting)

First time to Power ON:

Reset the transceiver using the following procedure.

Resetting **CLEARs** all the programmed contents in the memory channels, and returns all the programmed items in the Set mode to their default settings.

- ① Make sure the transceiver's power is OFF.
- ② While holding down both [F-INP ENT] and [M-CLR], push [POWER] to turn ON the transceiver.
 - The CPU is reset.
 - The transceiver displays "ALL CLEAR," then displays its initial VFO frequency when resetting is complete.
- ③ Change the Set mode settings to suit your operating needs. (p. 85)

Normal Power ON:

Push [POWER] to turn ON the transceiver.

Power OFF:

Hold down [POWER] for 1 second to turn OFF the transceiver.

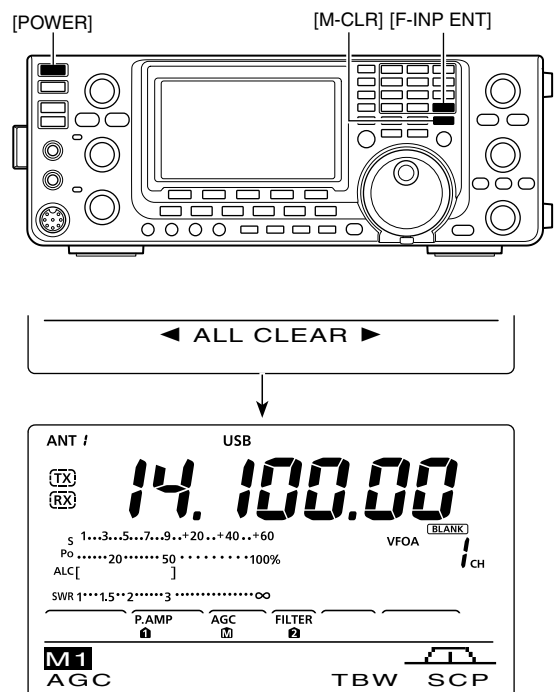

■ VFO description

The IC-7410 has two VFOs; “A” and “B,” that are convenient for quickly selecting two frequencies, or split frequency operation. You can use either VFO to call up a frequency and operating mode.

VFO is an abbreviation of Variable Frequency Oscillator.

◇ Selecting the VFO A/B

➔ Push [A/B] to switch between the VFO A and VFO B.

- “VFOA” or “VFOB” appears when the VFO is selected.

◇ VFO equalization

➔ Hold down [A=B] for 1 second to equalize the data in both VFOs.

- Three beeps sound when the equalization is complete.

CONVENIENT!

Use two VFOs as quick memories:

When you find a new station, but wish to continue searching, the dual VFO system can be used for quick memory storage.

- ① Hold down [A=B] for 1 second to store the displayed data into the undisplayed VFO.
- ② Continue searching for stations.
- ③ Push [A/B] to show the stored data on the undisplayed VFO.
- ④ To continue searching for stations, push [A/B] again to show the displayed VFO.

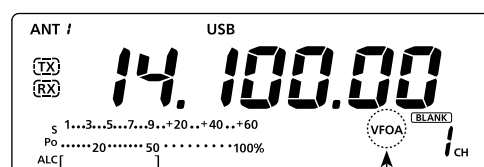
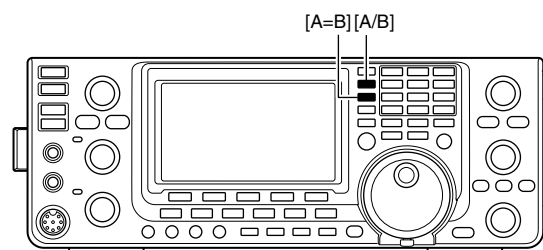

The selected VFO icon

Displayed VFO

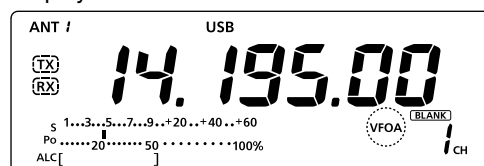

Undisplayed VFO

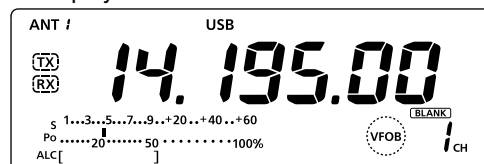

- ① Hold down [A=B]
- ③ Push [A/B]

■ Selecting VFO/Memory mode

➔ Push [VFO/MEMO] to toggle between the VFO and Memory modes.

- “VFOA” or “VFOB” appears when in the VFO mode.
- “MEMO” appears when in the Memory mode.
- Holding down [VFO/MEMO] for 1 second copies the contents of the selected Memory channel into the displayed VFO. (p. 72)

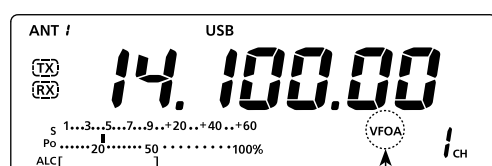
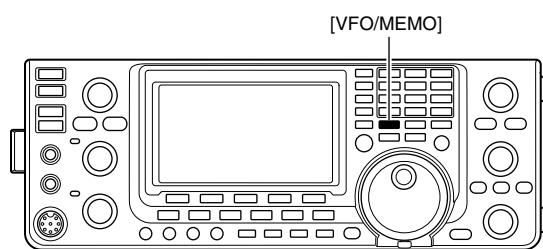

The selected VFO icon

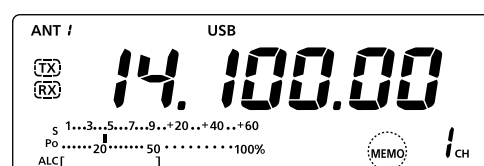

The memory icon

■ Selecting a frequency band

The triple band stacking register provides three memories for each band key to store frequencies and operating modes.

This function is convenient when you operate three operating modes on one frequency band. For example, one register can be used for a CW frequency, another for an SSB frequency and the other one for an RTTY frequency.

See the table below for a list of the bands available and the default settings for each band.

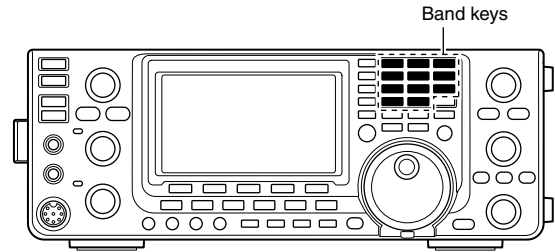

BAND	REGISTER 1	REGISTER 2	REGISTER 3
1.8 MHz*1	1.900000 MHz CW	1.910000 MHz CW	1.915000 MHz CW
3.5 MHz*1	3.550000 MHz LSB	3.560000 MHz LSB	3.580000 MHz LSB
7 MHz	7.050000 MHz LSB	7.060000 MHz LSB	7.020000 MHz CW
10 MHz*1	10.120000 MHz CW	10.130000 MHz CW	10.140000 MHz CW
14 MHz	14.100000 MHz USB	14.200000 MHz USB	14.050000 MHz CW
18 MHz	18.100000 MHz USB	18.130000 MHz USB	18.150000 MHz USB
21 MHz	21.200000 MHz USB	21.300000 MHz USB	21.050000 MHz CW
24 MHz	24.950000 MHz USB	24.980000 MHz USB	24.900000 MHz CW
28 MHz	28.500000 MHz USB	29.500000 MHz USB	28.100000 MHz CW
50 MHz*1	50.100000 MHz USB	50.200000 MHz USB	51.000000 MHz FM
General*2	15.000000 MHz USB	15.100000 MHz USB	15.200000 MHz USB

*1 The default frequency and mode settings are differ depending on the version. Above list shows the USA version's.

*2 [GENE •] selects the general coverage band.

◇ Using the band stacking registers.

- ① Push a band key ([1.8 1] to [50 0] or [GENE •]).
 - The previously selected frequency and operating mode are called up as the first band stacking register of that frequency band.
- ② Select a frequency and an operating mode, and then push the band key.
 - The selected frequency and mode are memorized as that frequency band's first band stacking register.
- ③ Select another frequency and operating mode, and then push the band key.
 - The selected frequency and mode are memorized as that frequency band's second band stacking register.
- ④ Select another frequency and operating mode, and then push the band key.
 - The selected frequency and mode are memorized as that frequency band's third band stacking register.
- ⑤ The first band stacking register set in step ②, is called up.
 - When the frequency band key is pushed, the memorized triple band stacking registers are sequentially called up.

[Example]: 14 MHz frequency band



■ Frequency setting

You can select the transceiver's frequency by using [DIAL], or you can enter it using the keypad.

◇ Tuning with [DIAL]

- ① Select the desired frequency band.
 - Push a band key 1–3 times. Three different frequencies on each frequency band can be selected with the band key. (See the previous page “Using the band stacking registers.”)
 - The default tuning step differs, depending on the operating mode.
 - SSB/CW/RTTY: 10 Hz
 - AM : 1 kHz (“▼” is displayed)
 - FM : 10 kHz (“▼” is displayed)
- ② Rotate [DIAL] to set the desired frequency.

/// If the Dial Lock function is ON, “” is displayed, and [DIAL] does not function.
 /// In this case, push [LOCK] to turn OFF the Dial Lock function. (p. 61)

◇ Direct frequency entry with the keypad

The transceiver has a keypad for direct frequency entry, as described below.

- ① Push [F-INP ENT] to enter frequencies with the keypad.
 - All frequency digits disappear.
- ② Push the numeric keys to input the desired frequency.
 - Push [GENE •] to input a “.” (decimal point) between the MHz digits and kHz digits.
- ③ Push [F-INP ENT] to set the input frequency.
 - To cancel the input, push any key such as [MW] or [M-CLR], before pushing [F-INP ENT].

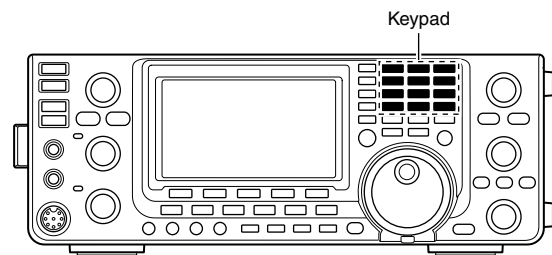
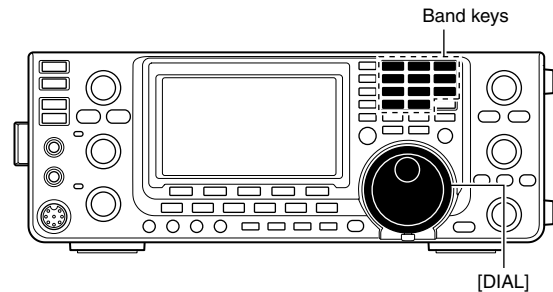

[EXAMPLE]

14.025 MHz

[F-INP ENT] 1.8 1 10 4 [GENE •] 50 0 3.5 2 14 5 [F-INP ENT]

18.0725 MHz

[F-INP ENT] 1.8 1 24 8 [GENE •] 50 0 21 7 3.5 2 14 5 [F-INP ENT]

706 kHz

[F-INP ENT] 50 0 [GENE •] 21 7 50 0 18 6 [F-INP ENT]

5.100 MHz

[F-INP ENT] 14 5 [GENE •] 1.8 1 [F-INP ENT]

7.000 MHz

[F-INP ENT] 21 7 [F-INP ENT]

21.280 MHz ⇄ 21.245 MHz

[F-INP ENT] [GENE •] 3.5 2 10 4 14 5 [F-INP ENT]

3 BASIC OPERATION

■ Frequency setting (continued)

◇ Quick Tuning function

The operating frequency can be changed in “kHz” steps for quick tuning. You can set a tuning step in each operating mode.

- ① Push [TS] to turn ON the Quick Tuning function.
 - “▼” appears above the 1 kHz digit.
- ② Hold down [TS] for 1 second to display the “TS” screen (Tuning Step).
- ③ Select a desired operating mode.
- ④ Rotate [DIAL] to select a tuning step.
 - 0.1, 1, 5, 9, 10, 12.5, 20, and 25 kHz are selectable.
 - Hold down [F-3] for 1 second to reset to the default setting, if desired.
- ⑤ Repeat steps ③ and ④ to select quick tuning steps for other modes.
- ⑥ Push [TS] to exit the “TS” screen.

NOTE:

- To turn OFF the Quick Tuning function, push [TS] again.
- When the Quick Tuning function is OFF, the frequency will be changed in 10 Hz steps.
- To display the “TS” screen, the Quick Tuning function must be turned ON first.

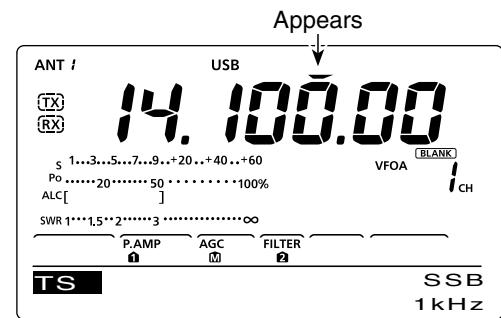
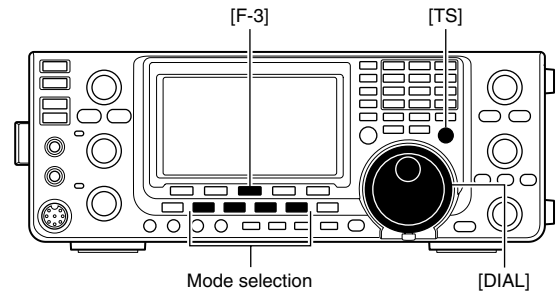

◇ Selecting 1 Hz step

You can change the frequency in 1 Hz steps for fine tuning.

- ① If the Quick Tuning function is ON, push [TS] to turn OFF.
- ② Hold down [TS] for 1 second to turn the 1 Hz tuning step ON or OFF.

NOTE:

- When RIT and/or ΔTX are used, they also tune in 1 Hz tuning steps.
- The frequency changes in 50 Hz steps when the [UP]/[DN] switches of the microphone are used for frequency tuning (if the Quick Tuning function is OFF.)

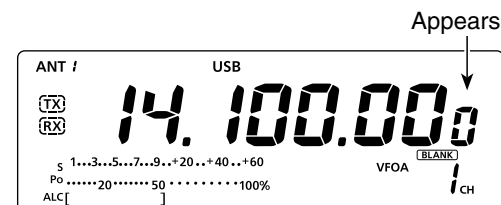
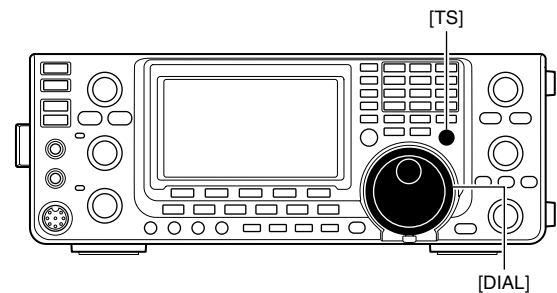

◇ 1/4 Tuning Step function

(Mode: SSB-D/CW/RTTY)

The dial speed is reduced to 1/4 of the normal speed when the 1/4 Tuning Step function is ON, for finer tuning control.

- ① Push [MENU] to display the “M1” screen (Menu 1).
- ② Push [1/4](F-3) to turn the 1/4 Tuning Step function ON or OFF.
 - “1/4” appears when the 1/4 Tuning Step function is ON.

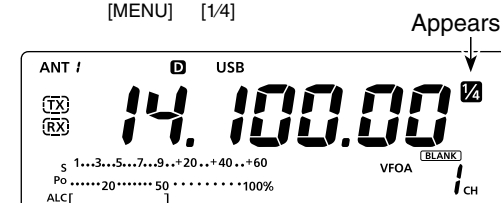
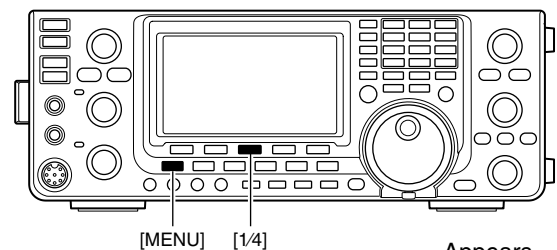

◇ Auto Tuning Step function

When you rotate [DIAL] rapidly, the tuning speed can automatically accelerate, depending on the “MAIN DIAL Auto TS” setting in the Set mode.

- ① Hold down [MENU] for 1 second to enter the Set mode.
- ② Push [▲](F-1) or [▼](F-2) to select “MAIN DIAL Auto TS.”
- ③ Rotate [DIAL] to select the HIGH or LOW tuning speed acceleration, or to turn OFF the function.
 - HIGH: When the tuning step is set to 1 kHz or smaller steps, the tuning speed is approximately five times faster.
When the tuning step is set to 5 kHz or larger steps, the tuning speed is approximately two times faster. (default)
 - LOW : Approximately two times faster.
 - OFF : Turns the function OFF.
 - Hold down [F-3] for 1 second to reset to the default setting, if desired.
- ④ Push [MENU] to save, and exit the Set mode.

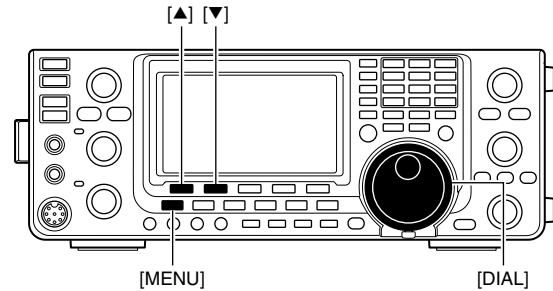

HIGH (default)

◇ About the 5 MHz frequency band operation (only USA version)

Operation on the 5 MHz band is allowed on 5 discrete frequencies and must adhere to the following:

- The USB mode
- Maximum of 50 watts ERP (Effective Radiated Power)
- 2.8 kHz bandwidth

It's your responsibility to set all controls so that transmission in this band meets the stringent conditions under which amateur operations may use these frequencies.

NOTE: We recommend that you store these frequencies, mode and filter settings into memory channels for easy recall.

*The FCC specifies center frequencies on the 5 MHz band. However, the transceiver displays carrier frequency. Therefore, tune the transceiver to 1.5 kHz below the specified FCC channel center frequency.

Transceiver Displayed Frequency*	FCC Channel Center Frequency*
5.33050 MHz	5.33200 MHz
5.34650 MHz	5.34800 MHz
5.36650 MHz	5.36800 MHz
5.37150 MHz	5.37300 MHz
5.40350 MHz	5.40500 MHz

To assist you in operating the 5 MHz band within the rules specified by the FCC, transmission is illegal on any 5 MHz band frequency other than the five frequencies shown in the table above.

■ Frequency setting (continued)

◇ **Band edge warning beep**

You can hear a beep tone when you tune in or out of an amateur band's frequency range. A regular beep sounds when you tune into a range, and an lower tone error beep sounds when you tune out of a range.

Also, the TX icon appears if the selected frequency is in or out of an amateur band, when an option other than "OFF" is selected.

- "TX" is displayed, instead of the regular TX icon "TX," while the operating frequency is out of an amateur band.

- ① Hold down [MENU] for 1 second to enter the Set mode.
- ② Push [▲](F-1) or [▼](F-2) to select "Band Edge Beep."
- ③ Rotate [DIAL] to select the desired band edge warning beep setting.
 - OFF : Band edge beep is OFF.
 - ON (Default) : When you tune into or out of the default amateur band's frequency range, a beep sounds. (default)
 - ON (User) : When you tune into or out of a user programmed amateur band's frequency range, a beep sounds.
 - ON (User) & TX: When you tune into or out of a user programmed amateur band's frequency range, a beep sounds. Also transmission is inhibited outside the programmed range.
- ④ Push [MENU] to save, and exit the Set mode.

/// The beep output level can be set in the "Beep Level" item of the Set mode. (p. 85)

About the user band edge frequencies

When "ON (User)" or "ON (User) & TX" is selected in the "Band Edge Beep" item, a total of 30 band edge frequencies can be programmed in the "User Band Edge" item. See the next page for details.

If "OFF" or "ON (Default)" is selected, the "User Band Edge" item does not appear in the Set mode.

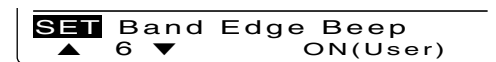
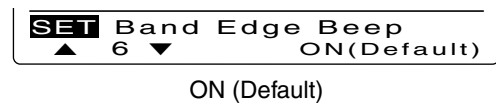
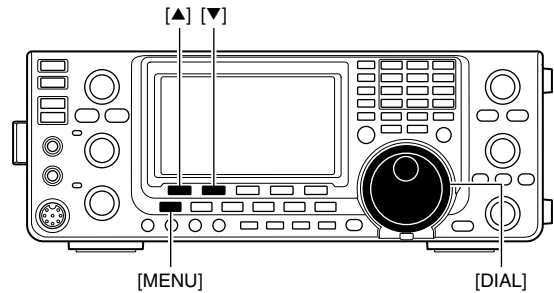

ON (User) selection

F-2



[User Band Edge] item

◇ Programming the user band edge

When “ON (User)” or “ON (User) & TX” is selected in the “Band Edge Beep” item, the “User Band Edge” item appears in the Set mode.

A total of 30 band edge frequencies can be programmed in the “User Band Edge” item.

NOTE:

- All frequency ranges are set to default, so you should delete or change them to add the desired band edge frequency.
- Program each channel from left to right and each frequency must be higher than the preceding frequency.
- The frequency that is duplicated, or out of an amateur band, cannot be programmed.

- ① Hold down [MENU] for 1 second to enter the Set mode.
- ② Push [▲](F-1) or [▼](F-2) to select “Band Edge Beep.”
- ③ Rotate [DIAL] to select either “ON (User)” or “ON (User) & TX.”
- ④ Push [▼](F-2) to select “User Band Edge.”
- ⑤ Push [EDT](F-4) to display the “EDG” screen (Band Edge Program).
- ⑥ Push [▲](F-1) or [▼](F-2) to select the desired band edge.
 - Holding down [▲](F-1) or [▼](F-2) continuously selects the band edges.
 - Push [◀▶](F-3) to select the upper or lower band edge frequency entry status.
 - Hold down [DEL](F-5) for 1 second to delete the selected band edge.
 - Push [INS](F-4) to insert a new blank band edge.
- ⑦ Input the desired frequency with the keypad, then push [F-INP ENT].
 - Push [GENE •] to input decimal point (“.”) between the MHz and kHz digits.
- ⑧ Push [MENU] to save.
- ⑨ Push [MENU] again to exit the Set mode.

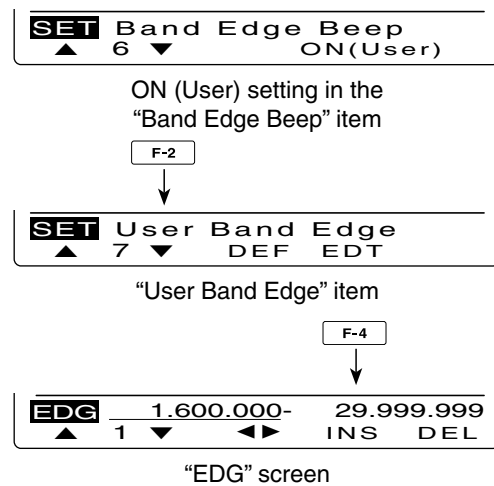
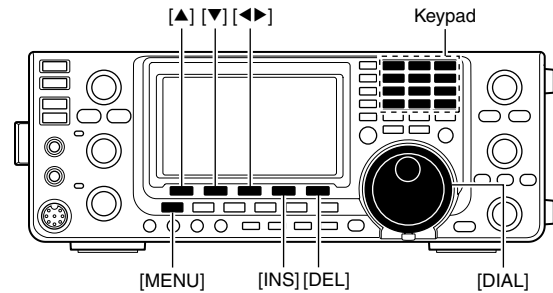

To reset the band edge frequencies

If you want to reset the band edge frequencies to their default (initial) settings, select the “User Band Edge” item, then hold down [DEF](F-3) for 1 second.

The band edge initialize screen appears, then hold down [YES](F-4) for 1 second to reset all band edge frequency settings to their default settings.

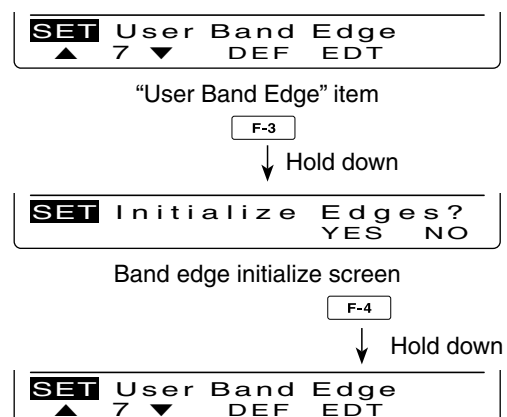

■ Operating mode selection

The usable operating modes in the IC-7410 are listed to the right.

You can select the desired operating mode by pushing the appropriate mode switch.

See the diagram to the right for the order of selection.

When the data mode is selected, you can mute the microphone signals, depending on the "DATA MOD" setting in the Set mode (p. 89).

• Usable operating modes

Mode switch	Operating mode	
[SSB]	USB	USB Data
	LSB	LSB Data
[CW]	CW	CW Reverse
[RTTY]	RTTY	RTTY Reverse
[AM/FM]	AM	AM Data
	FM	FM Data

• Selecting the SSB mode

➔ Push [SSB] to alternately select the USB or LSB mode.

- When operating above 10 MHz, USB is selected first; when operating below 10 MHz, LSB is selected first.
- After USB or LSB is selected, hold down [SSB] for 1 second to select the data mode.
- In the data mode, push [SSB] to return to the normal SSB mode.

• Selecting the CW mode

➔ Push [CW] to alternately select the CW or CW-R (CW reverse) mode.

• Selecting the RTTY mode

➔ Push [RTTY] to alternately select the RTTY or RTTY-R (RTTY reverse) mode.

• Selecting the AM/FM mode

➔ Push [AM/FM] to alternately select the AM or FM mode.

- After AM or FM is selected, hold down [AM/FM] for 1 second to select the data mode.
- In the data mode, push [AM/FM] to return to the normal AM or FM mode.

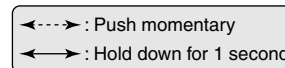
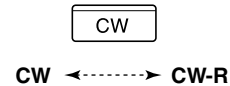
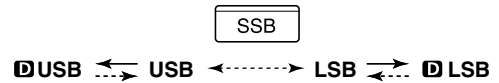
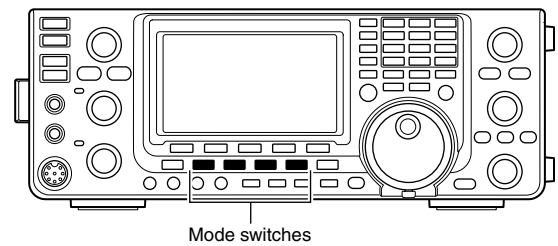

■ Volume setting

➔ Rotate the [AF] control clockwise to increase the audio output level, counterclockwise to decrease it.

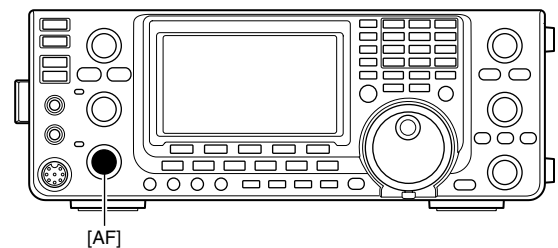
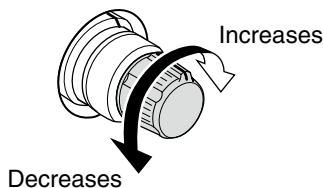

■ Squelch and receive (RF) sensitivity

Adjusts the RF gain and squelch threshold level. The squelch removes noise output to the speaker when no signal is received (closed position).

- The squelch is particularly effective for AM and FM, but can also be used in other modes.
- The 12 to 1 o'clock position is recommended for the most effective use of the [RF/SQL] control.
- [RF/SQL] can operate as only an RF gain control (Squelch is fixed open) or only a squelch control (RF gain is fixed at maximum sensitivity), depending on the "RF/SQL Control" setting in the Set mode. (p. 86)

SET MODE SETTING	OPERATING MODE	[RF/SQL] OPERATION
RF+SQL (default)	FM	Operates as an RF gain control, and a noise squelch or S-meter squelch.
	SSB/CW/RTTY/AM	Operates as an RF gain control, and an S-meter squelch.
SQL	ALL	Operates as only a squelch control. • RF gain is fixed at maximum sensitivity.
AUTO	SSB/CW/RTTY	Operates as only an RF gain control. • Squelch is fixed open.
	AM/FM	Operates as only a squelch control. • RF gain is fixed at maximum sensitivity.

○ Adjusting RF gain (Receive sensitivity)

Normally, [RF/SQL] is set to the 12 o'clock position. Rotate [RF/SQL] to the 11 o'clock position for maximum sensitivity.

- Rotating counterclockwise from the maximum position reduces sensitivity.
- The S-meter indicates receive sensitivity.

While rotating the RF gain control, noise may be heard. This comes from the DSP unit and does not indicate an equipment malfunction.

○ Adjusting squelch (Removing non-signal noise)

Rotate [RF/SQL] clockwise when no signal is received, until the noise just disappears.

- The RX indicator light goes out.
- Rotating [RF/SQL] past the threshold point activates the S-meter squelch— this allows you to set a minimum signal level needed to open the squelch.

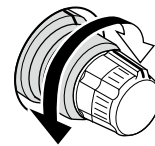
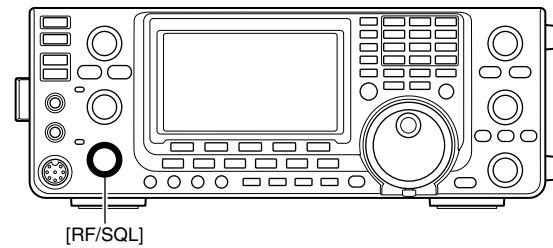

• When functioning as an RF gain/squelch control

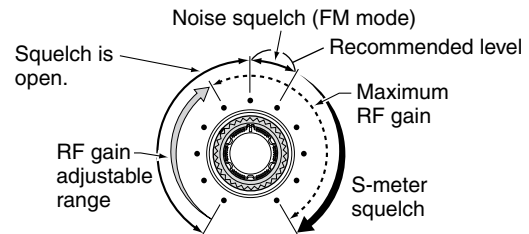

• When functioning as a squelch control (RF gain is fixed at maximum.)

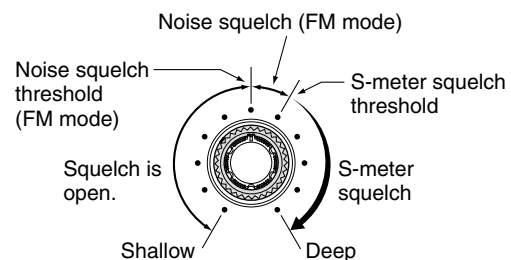

• When functioning as an RF gain control (Squelch is fixed open; SSB, CW, RTTY only)

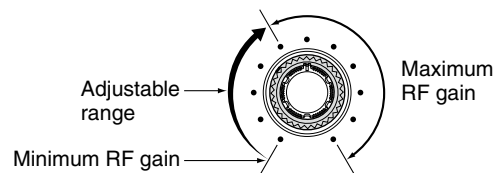

■ Voice synthesizer operation

The IC-7410 has a built-in voice synthesizer to announce the operating frequency, mode and S-meter level in clear, electronically-generated voice, in English (or Japanese).

First, select the desired parameters to be announced in the Set mode. (p. 87)

Initial values for the voice synthesizer parameters

- SPEECH Level : 50%
- SPEECH Language : English
- SPEECH Speed : HIGH
- SPEECH S-Level : ON
- SPEECH [MODE] SW : OFF

- Push [SPEECH] to announce the S-meter level* and currently selected frequency.
 - If you hold down [SPEECH] for 1 second, the transceiver announces the operating mode after the frequency.
 - * The S-meter level announcement can be turned OFF. (p. 87)
- Push a mode switch to announce the appropriate mode, when the “SPEECH [MODE] SW” item is set to “ON” in the Set mode. (p. 87)

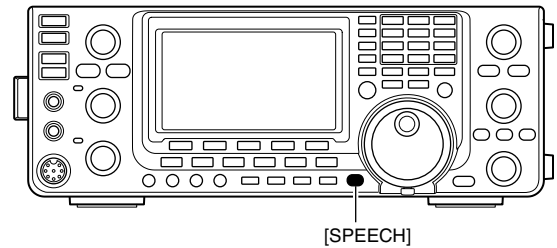

■ Meter Display selection

The transceiver has four transmit meter functions for your convenience. In addition to Po and ALC, you can display the SWR or COMP meter by holding down [ANT•METER] for 1 second.

- Po : Displays the RF output power in % (percent).
- ALC : Displays the ALC level. When the meter movement shows the input signal level exceeds the allowable level, the ALC limits the RF power. In such cases, rotate the [MIC] control counter-clockwise to decrease the microphone gain.
- SWR : Displays the SWR of the antenna at the frequency.
- COMP : Displays the compression level when the speech compressor is in use.

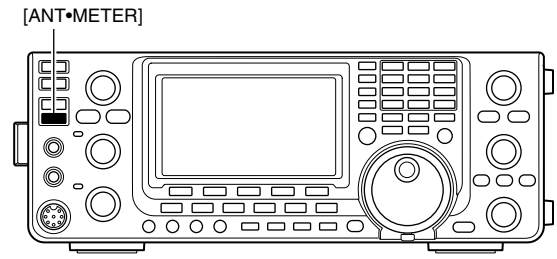

- When the SWR meter is selected.

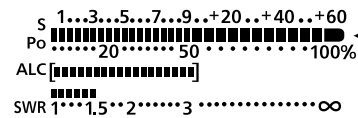

The RF output power meter becomes the S-meter in receive.

Basic transmit operation

Before transmitting, monitor the operating frequency to make sure transmitting won't cause interference to other stations on the same frequency. It's good amateur practice to listen first, and then, even if nothing is heard, ask "Is the frequency in use?" once or twice, before you begin operating on that frequency.

Transmitting

CAUTION: Transmitting without an antenna will damage the transceiver.

- ① Push [PTT] on the microphone to transmit (or [TRANSMIT] on the transceiver).
 - The TX indicator lights red.
- ② Release [PTT] to receive (or push [TRANSMIT] again).

Adjusting the transmit output power

- ➔ Rotate [RF PWR].
 - Adjustable range : 2 W to 100 W
(2 W to 27 W in the AM mode)

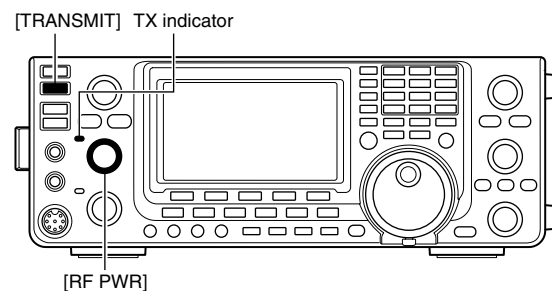
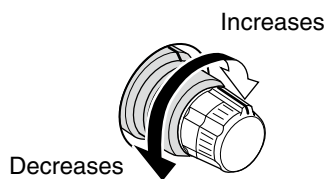

3

Microphone gain adjustment

(Mode: SSB/AM/FM)

- ① Push [PTT] on the microphone to transmit.
 - Speak into the microphone at your normal voice level.
- ② **In the SSB mode:**
While speaking into the microphone, rotate the [MIC] control so that the ALC meter reading stays within the ALC zone.

In the AM and FM modes:

While speaking into the microphone, rotate the [MIC] control with another station listening to your voice for clarity.

Recommended level for an Icom microphone

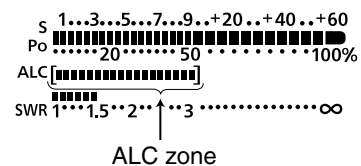
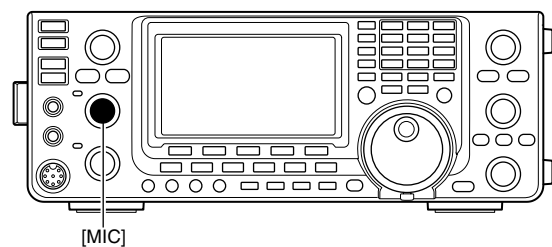
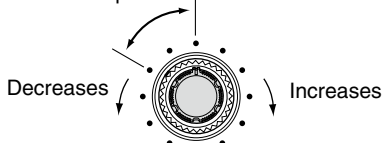

- ③ Release [PTT] to receive.

■ Operating SSB

- ① Select the desired band. (p. 25)
- ② Push [SSB] to select the LSB or USB mode.
 - When operating above 10 MHz, USB is selected first; when operating below 10 MHz, LSB is selected first.
 - If desired, after USB or LSB is selected, hold down [SSB] for 1 second to select the data mode.
- ③ Rotate [DIAL] to tune a desired signal.
 - The S-meter indicates the received signal strength.
 - The tuning step can be changed in the tuning step program mode. (p. 27)
- ④ Rotate the [AF] control to adjust the audio to a comfortable listening level.
- ⑤ Push [PTT] on the microphone to transmit (or [TRANSMIT] on the transceiver).
 - The TX indicator lights red.
- ⑥ Speak into the microphone at your normal voice level.
 - Rotate the [MIC] control to adjust the microphone gain at this step, if necessary.
- ⑦ Release [PTT] to receive (or push [TRANSMIT] again).

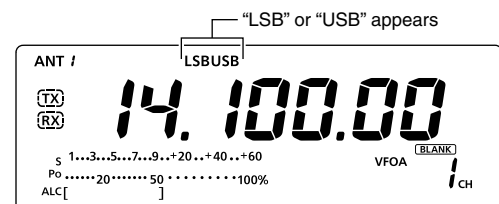
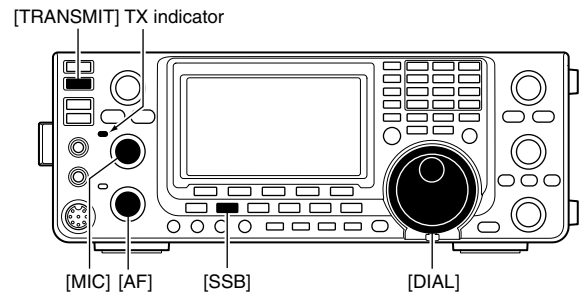

Convenient Receive functions

- Preamp and attenuator (p. 55)
- Twin PBT (Passband Tuning) (p. 59)
- AGC (Auto Gain Control) (p. 56)
- Noise Blanker (p. 60)
- Noise Reduction (p. 61)
- Notch filter (p. 61)
- VSC (Voice Squelch Control) (p. 76)

Convenient Transmit functions

- Speech Compressor (p. 64)
- VOX (Voice Operated Transmit) (p. 62)
- Transmit quality monitor (p. 65)
- Transmit filter width selection (p. 64)
- Audio tone control (pp. 90, 91)

■ Operating CW

- ① Select the desired band. (p. 25)
- ② Push [CW] to select the CW mode.
 - Pushing [CW] alternately selects CW or CW reverse mode.
- ③ Rotate [DIAL] to tune a desired signal.
 - The S-meter indicates the received signal strength.
 - The tuning step can be changed in the tuning step program mode. (p. 27)
- ④ Rotate the [AF] control to adjust the audio to a comfortable listening level.
- ⑤ Push [TRANSMIT] to transmit.
 - The TX indicator lights red.
- ⑥ Use the electric keyer or paddle to key your CW signals.
 - The Po meter indicates transmitted CW output power.
- ⑦ Push [TRANSMIT] again to receive.

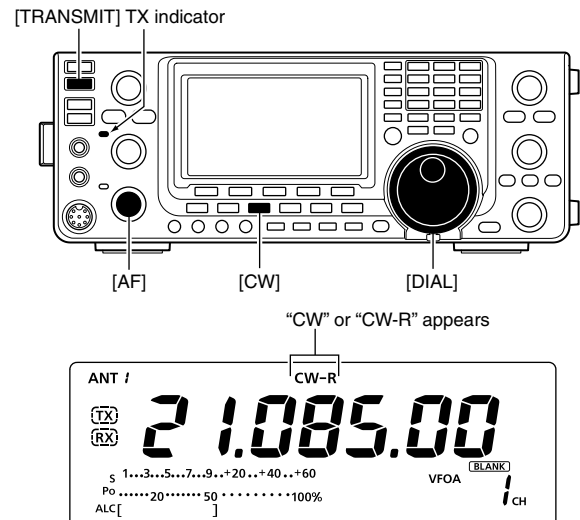

Convenient Receive functions

- Preamp and attenuator (p. 55)
- Twin PBT (passband tuning) (p. 59)
- AGC (Auto Gain Control) (p. 56)
- Noise Blanker (p. 60)
- Noise Reduction (p. 61)
- Manual Notch filter (p. 61)
- CW pitch control (p. 37)
- $\frac{1}{4}$ function (p. 27)

Convenient Transmit functions

- Break-in function (p. 63)
- Keying speed setting (p. 37)
- Memory keyer (p. 38)

■ Operating CW (continued)

◇ About the CW reverse mode

The CW reverse mode receives signals with a reverse side CW carrier point similar to voice of the LSB and USB modes.

Use when interfering signals are near a desired signal, and you want to reduce the interfering tone.

- Push [CW] to alternately select the CW or CW reverse mode.
 - Check that the interfering tone can be reduced.

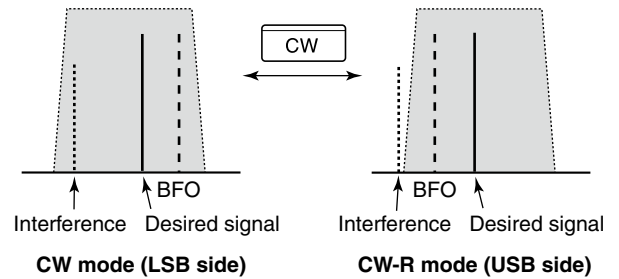

◇ About CW pitch control

The received CW audio pitch and CW sidetone can be adjusted to suit your preference, without changing the operating frequency.

- Rotate the [CW PITCH] control to suit your preference.
 - Adjustable from 300 to 900 Hz (in 5 Hz steps)

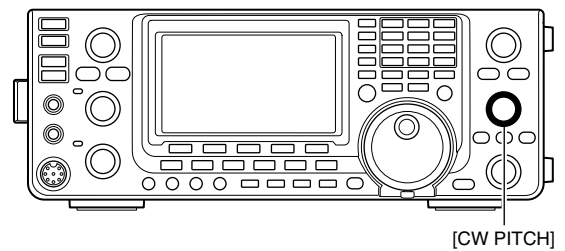

◇ About keying speed

The transceiver's internal electronic keyer speed can be adjusted between 6 and 48 wpm (wards per minute).

- Rotate the [KEY SPEED] control clockwise to increase keying speed; counterclockwise to decrease keying speed.

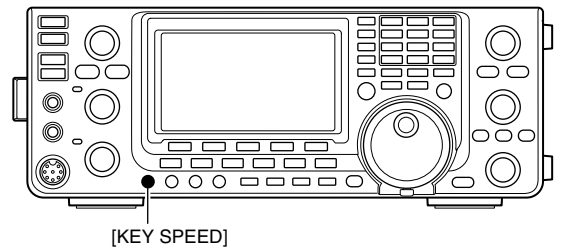

◇ CW sidetone function

When the transceiver is in the receive mode (and the Break-in function is OFF— p. 63), you can listen to the CW sidetone without actually transmitting.

You can also use the CW sidetone to practice CW sending, but be sure to turn OFF the Break-in function.

The CW sidetone level can be adjusted in the “Side Tone Level” item of the Keyer Set mode (p. 42).

■ Electronic keyer functions

You can access a number of convenient functions of the built-in electronic keyer in the memory keyer menu.

- ① In the CW mode, push [MENU] to display the “M1” screen (Menu 1).
- ② Push [KEY](F-4) to display the “KEY” screen (Memory Keyer).
- ③ Push [SEND](F-2), [EDT](F-3), [001](F-4) or [SET] (F-5) to select the desired menu.
See the diagram below.
 - Push [MENU] to save, and return to the previous display.

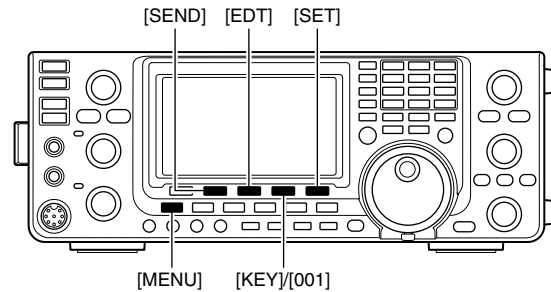

◇ Memory keyer menu construction

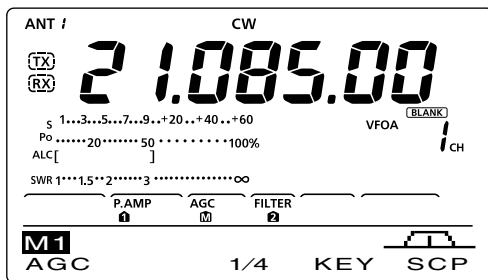

The screen you want to appear first can be selected in the “KEYER 1st Menu” item of the Set mode. (p. 88)

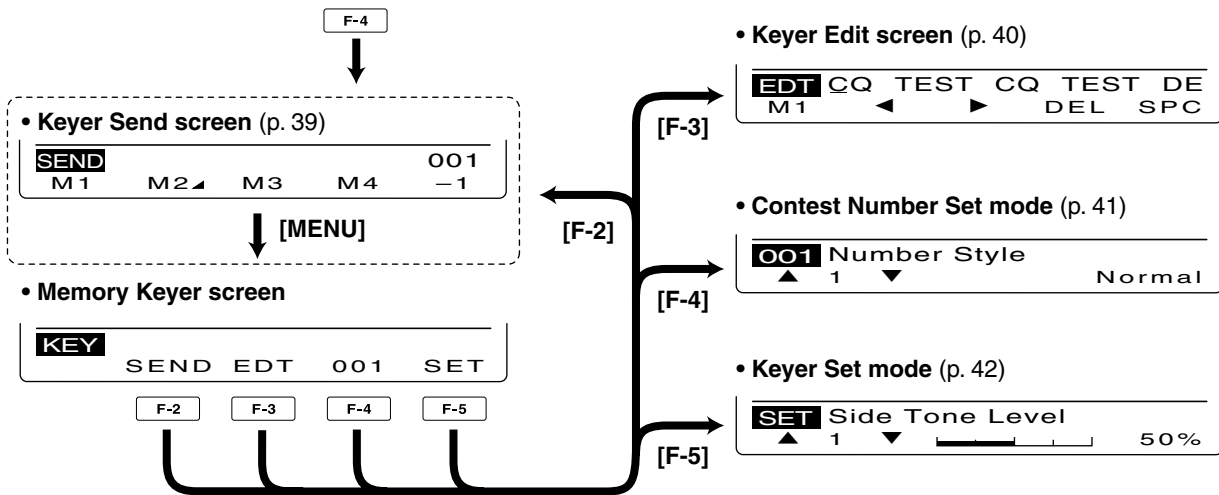

■ Electronic keyer functions (continued)

◇ Memory keyer send menu

Pre-set characters can be sent using the Keyer Send menu. Contents of the memory keyer are set in the Edit menu.

• Transmitting

- ① In the CW mode, push [MENU] to display the “M1” screen (Menu 1).
- ② Push [KEY](F-4) to display the “KEY” screen (Memory Keyer).
- ③ Push [SEND](F-2) to display the “SEND” screen (Keyer Send).
- ④ Push [TRANSMIT] to switch the transceiver to transmit, or turn ON the Break-in function. (p. 63)
- ⑤ Push one of the function keys, [M1](F-1) to [M4](F-4), to send the memory keyer contents.
 - Holding down a function key for 1 second repeatedly sends the contents; push any function key to cancel the transmission.
 - The contest serial number counter advances each time the contents are sent.
 - Push [-1](F-5) to reduce the contest serial number advances by 1 before sending the memory keyer contents to a station a second time.
 - Set the memory keyer repeat interval to between 1 and 60 seconds (1 second steps) in the “Keyer Repeat Time” item of the Keyer Set mode. (p. 42)
- ⑥ Push [MENU], and return to the “KEY” screen.
- ⑦ Push [MENU] again to return to the “M1” screen.

▨ For your information

When an external keypad is connected to pin 3 and pin 7 of the [MIC] connector, the contents of M1 to M4 can be transmitted without selecting the keyer send menu.
See page 92 for details.

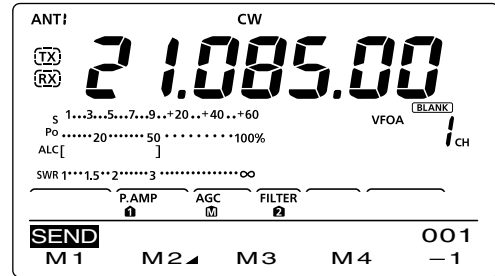

• M1 sending display



• M2 sending display

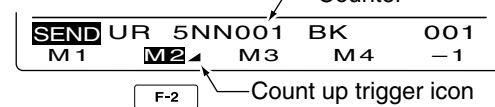

• M3 sending display

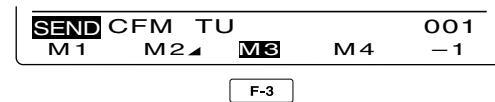

• M4 sending display

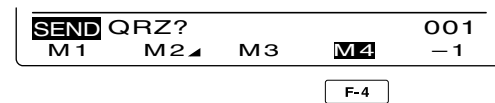

• While transmitting repeatedly

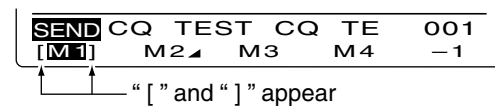

◇ Editing a memory keyer

The contents of the memory keyer memories can be set using the memory keyer edit menu. The memory keyer can memorize and re-transmit 4 CW key codes for often-used CW sentences, contest serial numbers or a count up trigger. The total capacity of the memory keyer is 70 characters per memory channel.

• Programming contents

- ① In the CW mode, push [MENU] to display the “M1” screen (Menu 1).
- ② Push [KEY](F-4) to display the “KEY” screen (Memory Keyer).
- ③ Push [EDT](F-3) to display the “EDT” screen (Keyer Edit).
 - The memory keyer content of Channel 1 (M1) is displayed.
- ④ Push [F-1] one or more times to select the memory keyer channel to be edited.
- ⑤ Rotate [DIAL] to select a character, or push the keypad to input a number.
 - Push [DEL](F-4) to delete the selected character or number.
 - Push [SPC](F-5) to input a space.
 - An error beep sounds when you try to input more than 70 characters. To delete a character or number, push [◀](F-2) or [▶](F-3) to select it, then push [DEL](F-4) to delete.

Selectable characters
A to Z/? ^ . , @ *

- ⑥ Push [◀](F-2) to move the cursor backward, or push [▶](F-3) to move the cursor forward.
- ⑦ Repeat steps ⑤ and ⑥ to program up to 70 characters memory keyer contents.
- ⑧ Push [MENU] to save, and return to the “KEY” screen.
- ⑨ Push [MENU] again to return to the “M1” screen.

NOTE:

“^” is used to transmit a string of characters with no inter-character space. Put “^” before a text string such as ^AR, and the string “AR” is sent with no space.
 “*” is used to insert the CW contest serial number. The serial number automatically advances by 1. This function is available for only one memory keyer channel at a time. “*” is used in memory keyer channel M2 by default.

Pre-programmed memory keyer contents

Memory keyer channel	Contents
M1	CQ TEST CQ TEST DE JA1 JA1 TEST
M2	UR 5NN* BK
M3	CFM TU
M4	QRZ?

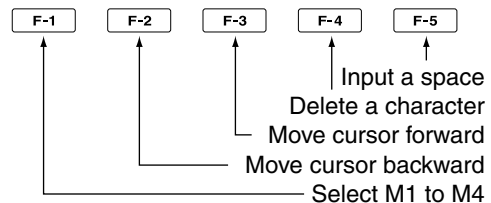
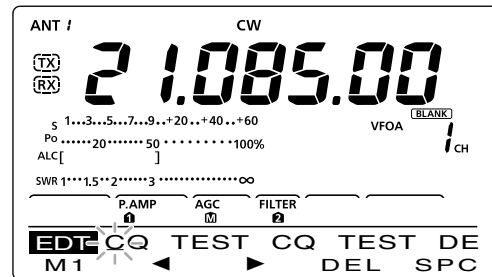

• M2 default indication

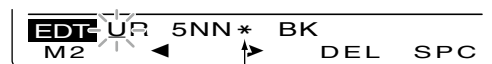

When inputting an asterisk, the counter is incremented by 1.

• M3 default indication



• M4 default indication



Example display— Inputting “QSL TU DE JA3YUA TEST” into the memory keyer channel 3 (M3).



■ Electronic keyer functions (continued)

◇ Contest number Set mode

This mode is used to set the contest number and count up trigger, etc.

• Setting contents

- ① In the CW mode, push [MENU] to display the “M1” screen (Menu 1).
- ② Push [KEY](F-4) to display the “KEY” screen (Memory Keyer).
- ③ Push [001](F-4) to enter the Contest Number Set mode.
- ④ Push [▲](F-1) or [▼](F-2) to select the desired item.
- ⑤ Rotate [DIAL] to select the desired option.
 - Hold down [F-3] for 1 second to reset to the default setting, if desired.
- ⑥ Push [MENU] to save, and return to the “KEY” screen.
- ⑦ Push [MENU] again to return to the “M1” screen.

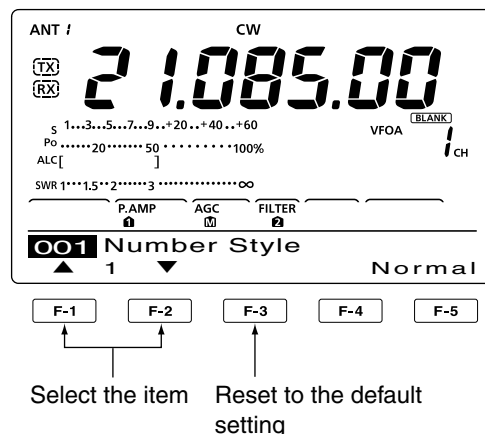

1. Number Style (Default: Normal)

This item sets the numbering system used for contest numbers— normal or short morse numbers.

Short morse numbers are also referred to as “cut” numbers.

- Normal : Does not use short morse numbers
- 190→ANO : Sets 1 as A, 9 as N and 0 as O.
- 190→ANT : Sets 1 as A, 9 as N and 0 as T.
- 90→ NO : Sets 9 as N and 0 as O.
- 90→ NT : Sets 9 as N and 0 as T.

2. Count Up Trigger (Default: M2)

Set the count-up trigger to one of four memory slots for the contest number exchange. The count-up trigger allows the contest number to automatically advance after each complete serial number exchange is sent.

- M1, M2, M3 or M4 can be set.

3. Present Number (Default: 001)

This item shows the current number for the count-up trigger channel set above.

- Rotate [DIAL] to change the number, or hold down [F-3](CLR) for 1 second to reset the current number to 001.

◇ Keyer Set mode

This Set mode is used to set the CW sidetone, memory keyer repeat time, dash weight, paddle specifications, keyer type, etc.

• Setting contents

- ① In the CW mode, push [MENU] to display the “M1” screen (Menu 1).
- ② Push [KEY](F-4) to display the “KEY” screen (Memory Keyer).
- ③ Push [SET](F-5) to enter the Keyer Set mode.
- ④ Push [▲](F-1) or [▼](F-2) to select the desired item.
- ⑤ Rotate [DIAL] to select the desired option.
 - Hold down [F-3] for 1 second to reset to the default setting, if desired.
- ⑥ Push [MENU] to save, and return to the “KEY” screen.
- ⑦ Push [MENU] again to return to the “M1” screen.

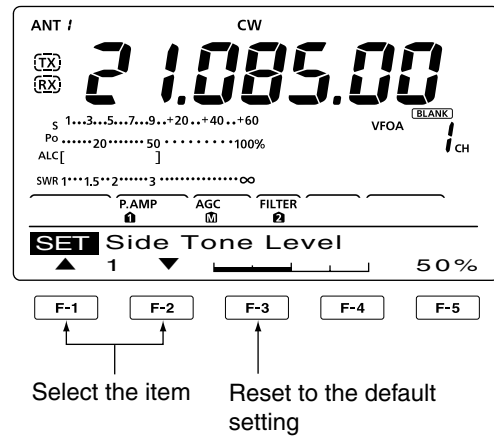

1. Side Tone Level (Default: 50%)

Select the CW sidetone output level.

- 0 to 100% in 1% steps can be selected.

2. Side Tone L-Limit (Default: ON)

Set the CW sidetone level limit. When the [AF] control is rotated above a specified level, the CW sidetone does not increase.

- ON : CW sidetone level is limited.
- OFF : CW sidetone level is not limited.

3. Keyer Repeat Time (Default: 2s)

When sending CW using the repeat timer, this item sets the time between transmission.

- 1 to 60 seconds in 1 second steps can be selected.

4. Message Display (Default: Normal)

When you are in the “SEND” screen (Keyer Send), channel numbers are displayed above the function keys. However, you can display the first three characters of the keyer memory instead of the channel number.

Select whether to display the channel number or the first three characters of the keyer.

- Normal : Displays the channel number.
- Message : Displays the first three characters of the keyer memory.

5. Dot/Dash Ratio (Default: 1:1:3.0)

Set the dot/dash ratio.

- 1:1:2.8 to 1:1:4.5 (in 0.1 steps) can be selected.

Keying weight example: Morse code “K”

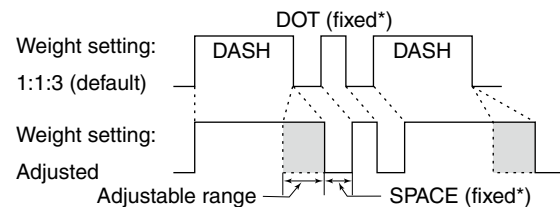

*SPACE and DOT length can be adjusted with only [KEY SPEED].

6. Rise Time (Default: 4ms)

This item sets the rise time of the transmitted CW envelope.

- 2, 4, 6 or 8 milliseconds can be selected.

About rise time

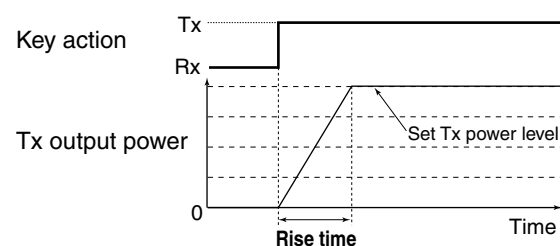

▨ If the rise time of a CW waveform is too short, key clicks on nearby frequencies can be generated.

☞ Continued on the next page.

◇ Keyer set mode (continued)

7. Paddle Polarity (Default: NORMAL)

Set the paddle polarity.

- Normal or reverse polarity can be selected.

8. Keyer Type (Default: ELEC-KEY)

Select the keyer type for the [ELEC-KEY] connector on the front panel.

- Straight key, BUG-KEY or ELEC-KEY can be selected.

9. MIC Up/Down Keyer (Default: OFF)

Set the microphone [UP]/[DN] switches to be used as a key. (The microphone [UP]/[DN] switches do not work as a 'squeeze key'.)

- ON : The [UP]/[DN] switches can be used as a key for CW.
- OFF : The [UP]/[DN] switches cannot be used as a key for CW.

/// **NOTE:** When "ON" is selected, the frequency and memory channels cannot be changed using the [UP]/[DN] switches.

■ Operating RTTY (FSK)

When using your RTTY terminal or TNC, consult the manual that comes with the equipment.

- ① Select the desired band. (p. 25)
- ② Push [RTTY] to select the RTTY mode.
 - Pushing [RTTY] alternately selects the RTTY or RTTY reverse mode.
- ③ Rotate [DIAL] to tune a desired signal.
 - The S-meter indicates received signal strength.
 - If the received signal cannot be demodulated, try to select the RTTY reverse mode in step ②.
 - The tuning step can be changed in the tuning step program mode. (p. 27)
- ④ Push [TRANSMIT] to set the transceiver to the transmit mode, or transmit a SEND signal from your TNC.
 - The TX indicator lights red.
 - The Po meter displays the transmitted RTTY signal strength.
- ⑤ Use your PC or TNC (TU) to transmit RTTY (FSK) signals.
- ⑥ Push [TRANSMIT] to return to receive.

Convenient Receive functions

- Preamp and attenuator (p. 55)
- Twin PBT (Passband Tuning) (p. 59)
- AGC (Auto Gain Control) (p. 56)
- Noise Blanker (p. 60)
- Noise Reduction (p. 61)
- Notch filter (p. 61)
- ¼ function (p. 27)
- Twin Peak Filter (p. 47)

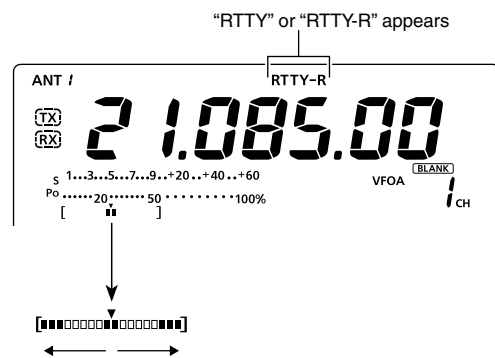
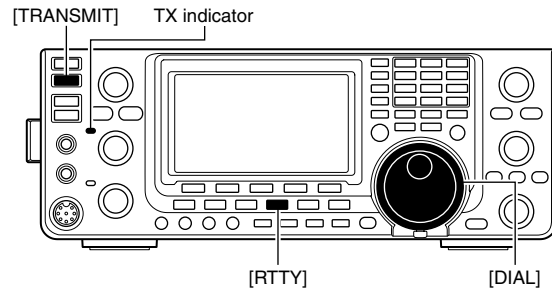

While receiving, the meter functions as the RTTY tuning meter to make correct tuning easier.

Rotate [DIAL] to the point where both sides of the dots appear equally.

* While transmitting, the meter functions as the transmit meter, selected by pushing [ANT•METER].

RTTY functions

The RTTY menu has a number of convenient functions for RTTY operation.

- ① Push [RTTY] to select the RTTY mode.
 - Pushing [RTTY] alternately selects the RTTY or RTTY reverse mode.
- ② Push [MENU] to display the “M1” screen (Menu 1).
- ③ Push [RTTY](F-4) to display the “RTTY” screen.
- ④ Push [DEC](F-2), [TPF](F-4) or [SET](F-5) to select the desired menu. See the diagram below.
 - Push [MENU] to return to the previous display.

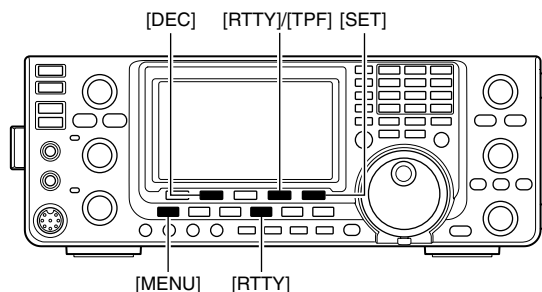

RTTY menu construction

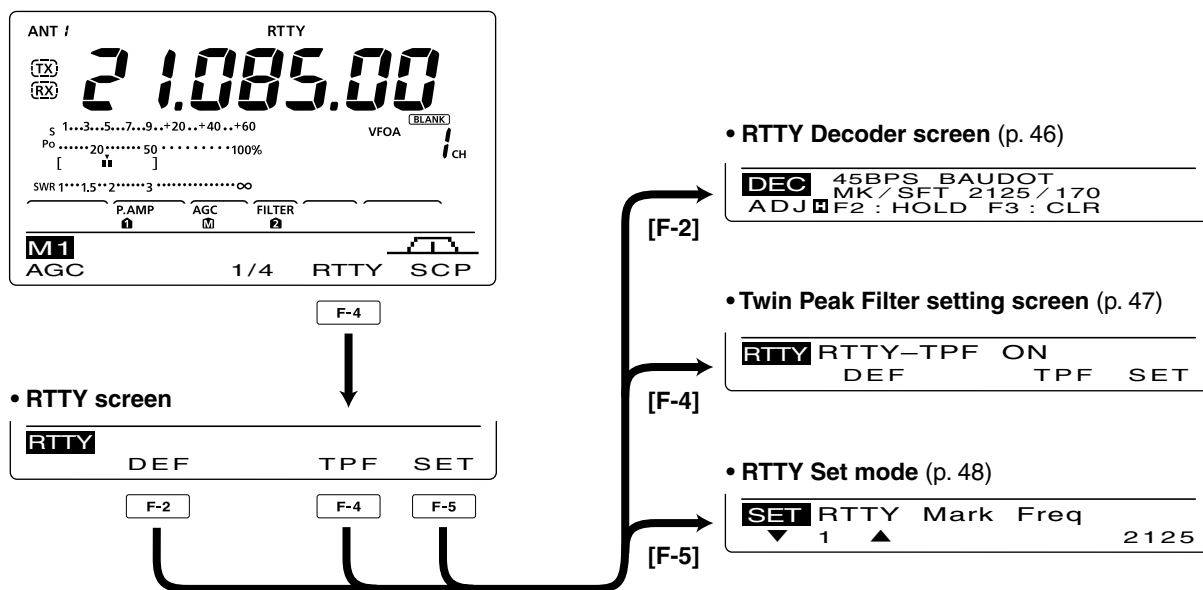

◆ **About the RTTY reverse mode**

Received characters are occasionally garbled when the Mark and Space signals are reversed. This reversal can be caused by incorrect TNC connections, setting or commands.

To receive reversed RTTY signals correctly, select the RTTY reverse mode.

- ➔ Push [RTTY] to alternately select the RTTY mode or RTTY reverse mode.

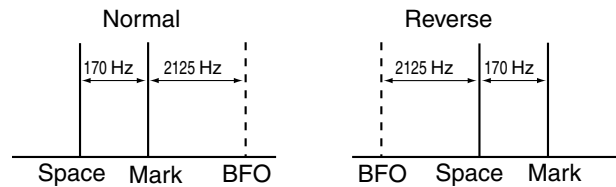

◆ **RTTY decoder**

The transceiver has an RTTY decoder for Baudot (mark freq.: 2125 Hz, shift freq.: 170 Hz, 45 bps).

An external terminal unit (TU) or terminal node connector (TNC) is not necessary for receiving a Baudot signal.

- ① In the RTTY mode, push [MENU] to display the “M1” screen (Menu 1).
- ② Push [RTTY](F-4) to display the “RTTY” screen.
- ③ Push [F-2](DEC) to turn ON the RTTY decoder.
 - RTTY decoder screen appears.
- ④ Push [F-2] to turn ON the Hold function to hold the current screen.
 - “H” appears when this function is turned ON.
 - Push [F-2] again to turn OFF the Hold function.
- ⑤ Hold down [F-3] for 1 second to clear the displayed characters, if desired.
 - “H” disappears at the same time as the displayed characters are cleared. (The hold function is cancelled.)
- ⑥ Push [MENU] to return to the previous display.

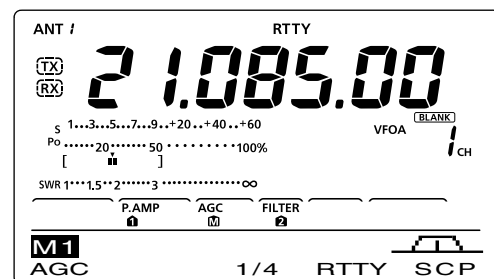

F-4

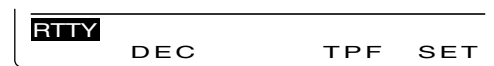

F-2



Appears when the Hold function is turned ON.

• **Setting the decoder threshold level**

If some characters are displayed when no signal is received, adjust the RTTY decoder threshold level.

- ① Select the RTTY decoder screen as described above.
- ② Push [F-1](ADJ) to select the threshold level adjustment mode.
- ③ Rotate [DIAL] to adjust the RTTY decoder threshold level.
 - Hold down [F-3] for 1 second to reset to the default setting, if desired.
- ④ Push [MENU] to save, and return to the previous display.



F-1



Threshold level display

▨ The number of the decoder display lines, the Un-Shift On Space (USOS) function and new line code can be set in the RTTY Set mode. (p. 48)

■ RTTY functions (continued)

◇ Twin Peak Filter

The Twin Peak Filter changes the receive frequency response by boosting 2125 and 2295 Hz for better copying of RTTY signals.

- ① In the RTTY mode, push [MENU] to display the “M1” screen (Menu 1).
- ② Push [RTTY](F-4) to display the “RTTY” screen.
- ③ Push [TPF](F-4) to turn the Twin Peak Filter ON or OFF.
- ④ Push [MENU] to save, and return to the previous display.

/// **NOTE:** When the Twin Peak Filter is in use, the received audio output may increase. This is normal; not a malfunction.

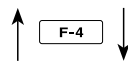
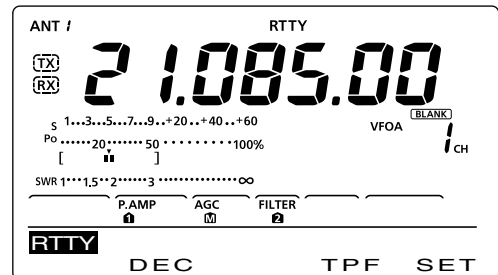

Appears when the Twin Peak Filter is ON.

◇ RTTY Set mode

The RTTY Set mode is used to set the mark and shift frequencies, keying type, decode USOS function, RTTY decoder new line code and the number of decode screen display lines.

• Setting contents

- ① In the RTTY mode, push [MENU] to display the “M1” screen (Menu 1).
- ② Push [RTTY](F-4) to display the “RTTY” screen.
- ③ Push [SET](F-5) to enter the RTTY Set mode.
- ④ Push [▲](F-1) or [▼](F-2) to select the desired item.
- ⑤ Rotate [DIAL] to select the desired option.
 - Hold down [F-3] for 1 second to reset to the default setting, if desired.
- ⑥ Push [MENU] to save, and return to the “RTTY” screen.
- ⑦ Push [MENU] again to return to the “M1” screen.

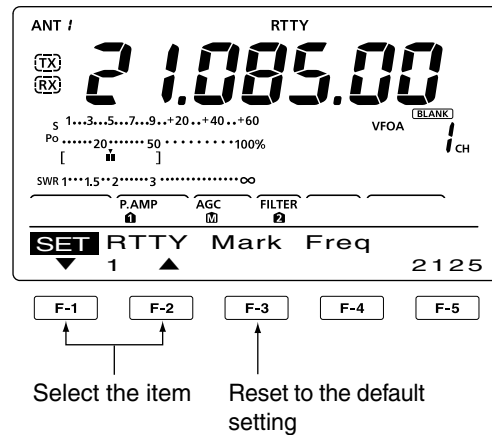

1. RTTY Mark Freq (Default: 2125)

Select the RTTY mark frequency.

- 1275, 1615 and 2125 Hz are selectable.

2. RTTY Shift Width (Default: 170)

Select the RTTY frequency shift.

- 170, 200 and 425 Hz are selectable.

3. RTTY Keying Pol (Default: NORMAL)

Select normal or reverse keying polarity.

- NORMAL : Key open/close = Mark/Space
- REVERSE : Key open/close = Space/Mark

4. Decode USOS (Default: ON)

Turn the USOS (UnShift On Space) function ON or OFF. This function decodes a letter code after receiving a “space.”

- OFF : Decodes as a character code
- ON : Decodes as a letter code

5. Decode New Line (Default: CR,LF,CR+LF)

Select the internal RTTY decoder new line code.
CR: Carriage Return, LF: Line Feed

- CR,LF,CR+LF : Makes a new line with any code.
- CR+LF : Makes a new line with only the CR+LF code.

6. Decode Screen (Default: 3 line)

Set the decoder screen display mode to 2 or 3 lines.

■ Operating AM/FM

- ① Select the desired band. (p. 25)
- ② Push [AM/FM] to select the AM or FM mode.
 - If desired, after AM or FM is selected, hold down [AM/FM] for 1 second to select the data mode.
- ③ Rotate [DIAL] to tune a desired signal.
 - The S-meter displays the received signal strength.
 - The tuning step can be changed in the tuning step program mode. (p. 27)
- ④ Rotate the [AF] control to adjust the audio to a comfortable listening level.
- ⑤ Push [PTT] on the microphone to transmit (or [TRANSMIT] on the transceiver).
 - The TX indicator lights red.
- ⑥ Speak into the microphone at your normal voice level.
 - Rotate the [MIC] control to adjust the microphone gain in this step, if necessary.
- ⑦ Release [PTT] to receive (or push [TRANSMIT] again).

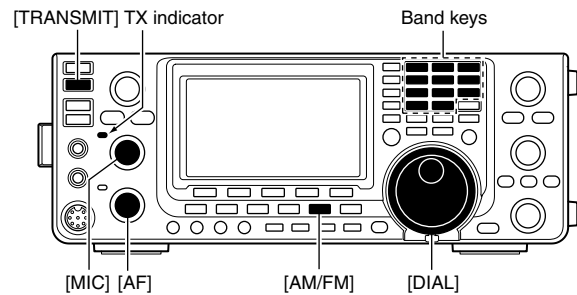

• AM mode

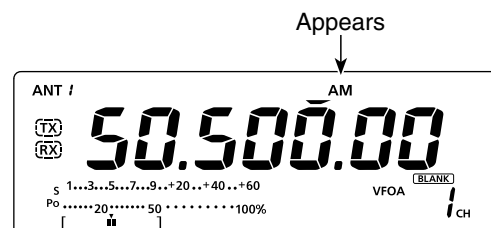

• FM mode

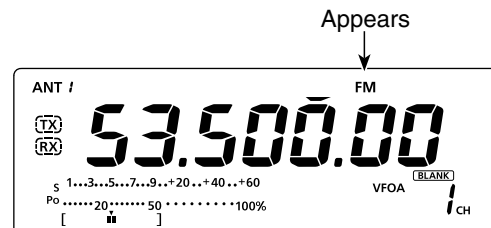

Convenient Receive functions

- Preamp and attenuator (p. 55)
- Twin PBT (Passband Tuning)* (p. 59)
- AGC (Auto Gain Control) (p. 56)
- Noise Blanker (p. 60)
- Noise Reduction (p. 61)
- Notch filter (p. 61)
- VSC (Voice Squelch Control) (p. 76)

*AM only

Convenient functions for transmit

- Speech Compressor (p. 64)
- VOX (Voice Operated Transmit) (p. 62)
- Transmit quality monitor (p. 65)
- Audio tone control (p. 90)

■ Tone squelch operation

The tone squelch opens only when you receive a signal containing a matching subaudible tone. You can silently wait for calls from others using the same tone.

- ① Push [AM/FM] once or twice to select the FM mode.
- ② Push [MENU] to display the “M1” screen (Menu 1).
- ③ Push [TON](F-4) one or more times to turn ON the Tone Squelch function.
 - “TSQL” appears
- ④ Hold down [TON](F-4) for 1 second to display the “TON” screen (Tone).
 - “TSQL Tone” appears on the function display.
- ⑤ Rotate [DIAL] to select the desired tone squelch frequency. (See the table shown below.)
 - Hold down [F-3] for 1 second to reset to the default setting, if desired.
- ⑥ Push [MENU] to save, and exit the “TON” screen.
- ⑦ Communicate in the usual manner.

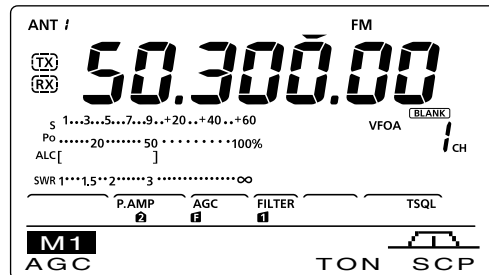
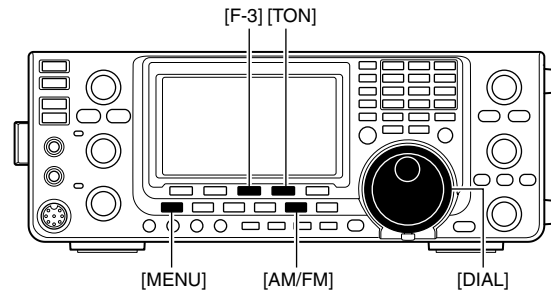

F-4

↓ Hold down



• Available tone squelch frequencies (Unit: Hz)

67.0	85.4	107.2	136.5	165.5	186.2	210.7	254.1
69.3	88.5	110.9	141.3	167.9	189.9	218.1	
71.9	91.5	114.8	146.2	171.3	192.8	225.7	
74.4	94.8	118.8	151.4	173.8	196.6	229.1	
77.0	97.4	123.0	156.7	177.3	199.5	233.6	
79.7	100.0	127.3	159.8	179.9	203.5	241.8	
82.5	103.5	131.8	162.2	183.5	206.5	250.3	

Tone scan operation

To search for a repeater's sub-audible tone, a tone scan is available.

By monitoring a repeater signal with a tone squelch, you can determine the tone frequency necessary to open the repeater or the squelch.

- ① In the FM mode, push [MENU] to display the "M1" screen (Menu 1).
- ② Hold down [TON](F-4) for 1 second to enter the "TON" screen (Tone).
- ③ Push [TON](F-1) one or more times to select the tone type to be scanned.
 - "Rptr Tone" for a repeater tone and "TSQL Tone" for tone squelch can be selected.
- ④ Push [SCAN](F-2) to start the Tone scan.
 - "Rptr Tone SCAN" or "TSQL Tone SCAN" blinks, depending on the type you selected.
- ⑤ When a matched tone is found, the scan pauses and the sub-audible tone frequency is automatically programmed.
 - Hold down [F-3] for 1 second to reset to the default setting, if desired.
- ⑥ Push [SCAN](F-2) to cancel the Tone scan.

When the tone scan is used in the Memory channel mode, the detected tone frequency can be used temporarily.

To save the detected tone frequency setting, you must over-write the Memory channel data. (p. 70)

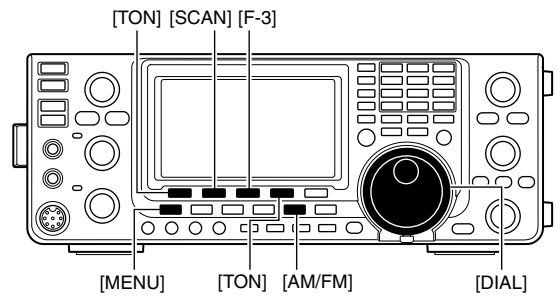

F-4
Hold down



F-1
Push to select the tone type.



F-2
Push to start or cancel the scan.

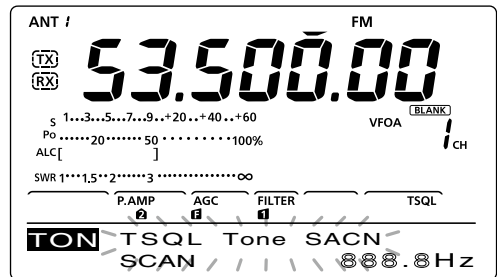

Repeater operation

A repeater receives transmitted signals and re-transmits them on a different frequency. When using a repeater, the transmit frequency is shifted from the receive frequency by a frequency offset.

A repeater can be accessed using the split frequency operation to set the frequency shift to the same value as the repeater's frequency offset.

- ① First, set the frequency offset for the HF and 50 MHz bands in the "FM SPLIT Offset HF" and "FM SPLIT Offset 50M" items, and set the "Quick SPLIT" item to "ON" in the Set mode. (p. 86)
- ② Push [VFO/MEMO] to select the VFO mode.
- ③ Select the desired band. (p. 25)
- ④ Push [AM/FM] to select the FM mode.
- ⑤ Rotate [DIAL] to set the receive frequency (repeater output frequency).
- ⑥ Hold down [SPLIT] to turn ON the Quick Split function.
 - "SPLIT" and "TONE" appear.
 - The tone frequency can be set in the "TON" screen (Tone). 88.5 Hz is set by default. (p. 52)
- ⑦ Communicate in the normal way.

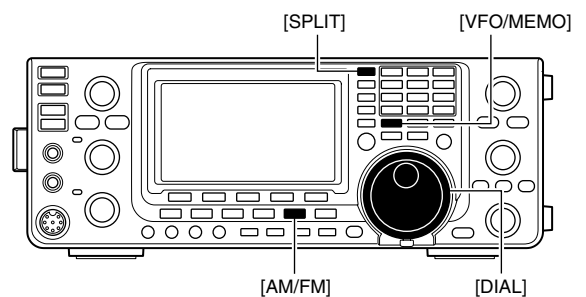

Appears

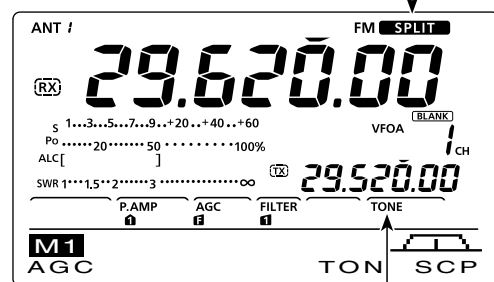

Appears

◇ Repeater access tone frequency setting

Some repeaters require a subaudible tone to be accessed. Subaudible tones are superimposed on your normal signal and must be set first. You can select 50 tones from 67.0 Hz to 254.1 Hz.

- ① In the FM mode, push [MENU] to display the “M1” screen (Menu 1).
- ② Push [TON](F-4) one or more times to turn ON the Tone Encoder function.
 - “TONE” appears.
- ③ Hold down [TON](F-4) for 1 second to display the “TON” screen (Tone).
 - “Rptr Tone” appears on the function display.
- ④ Rotate [DIAL] to select the desired repeater tone frequency. (See the table below.)
- ⑤ Push [MENU] to save, and exit the “TON” screen.

• Available tone frequencies (unit: Hz)

67.0	85.4	107.2	136.5	165.5	186.2	210.7	254.1
69.3	88.5	110.9	141.3	167.9	189.9	218.1	
71.9	91.5	114.8	146.2	171.3	192.8	225.7	
74.4	94.8	118.8	151.4	173.8	196.6	229.1	
77.0	97.4	123.0	156.7	177.3	199.5	233.6	
79.7	100.0	127.3	159.8	179.9	203.5	241.8	
82.5	103.5	131.8	162.2	183.5	206.5	250.3	

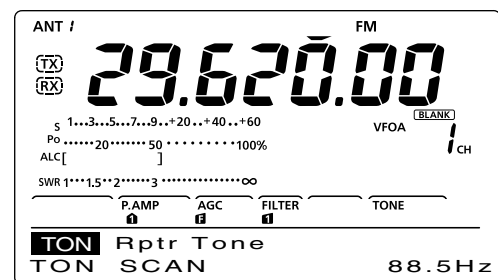
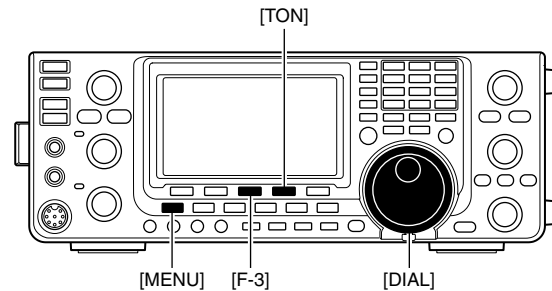

◇ Transmit frequency monitor check

You may be able to directly receive the other party's transmitted signal without having to go through a repeater. This function helps you to check whether or not the direct communication can be done.

- ➔ While receiving, hold down [XFC] to see if you can directly receive the other party's transmitted signal.
 - While holding down [XFC], the offset direction and frequency offset are displayed on the function display.

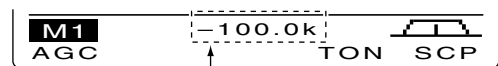
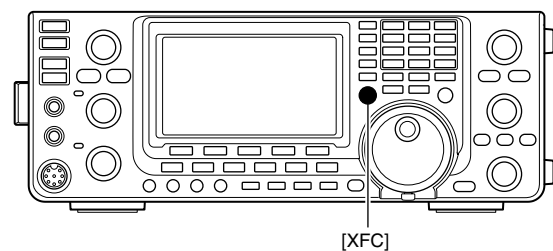

Offset direction and frequency

■ RIT function

The RIT (Receive Increment Tuning) function compensates for off-frequency operation of the received station.

The function shifts the receive frequency up to ± 9.99 kHz in 10 Hz steps*, without changing the transmit frequency.

*The [RIT/ Δ TX] control tunes in 1 Hz steps when the operating frequency readout is set to the 1 Hz step readout.

- ① Push [RIT] to turn ON the RIT function.
 - “RIT” and the frequency shift appear when this function is ON.
- ② Rotate the [RIT/ Δ TX] control.
 - Hold down [CLEAR] for 1 second to reset the RIT frequency.
 - Push [CLEAR] momentarily to reset the RIT frequency when the “Quick RIT Clear” item is set to “ON” in the Set mode. (p. 88)
 - Hold down [RIT] for 1 second to add the frequency shift to the operating frequency, if desired.
- ③ To cancel the RIT function, push [RIT] again.
 - “RIT” and the frequency shift disappear.

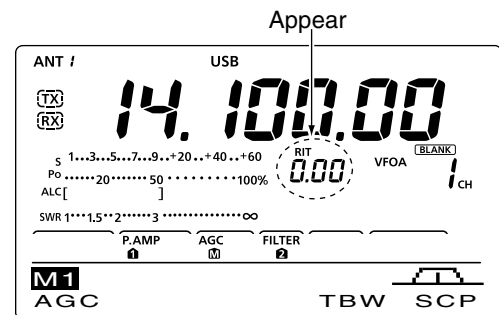
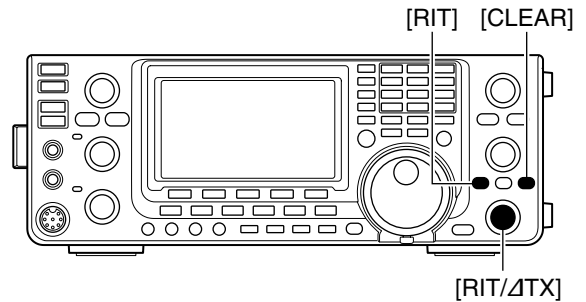

◇ RIT Monitor function

When the RIT function is ON, holding down [XFC] allows you to listen to the displayed frequency (RIT is temporarily cancelled).

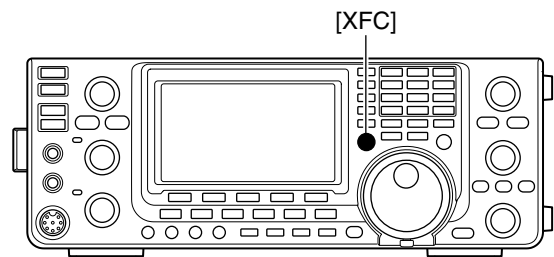

Simple band scope

The Band Scope function allows you to visually check the location and strength of signals around a specified frequency.

The IC-7410's Band Scope function can be used in any operating mode and any frequency band.

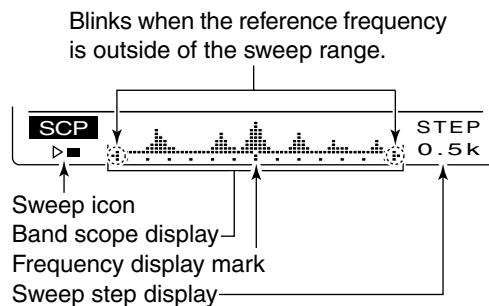

INDICATOR	DESCRIPTION
Sweep icon	While the band scope is sweeping, "▶ □" is displayed; while stopped, "▶ ■" is displayed. Received audio is not heard from the speaker while the band scope is sweeping.
Band scope display	Displays the signal location and strength in relation to the center (displayed) frequency. Signal strength is relative to the S-meter level, S1 to S9, with each vertical dot in the band scope indicator equal to one segment of the S-meter. Signal activity is measured ±30 steps from the center frequency, with each step equal to the selected sweep step.
Frequency display mark	After a sweep, displays the relative position of the reference frequency. When the reference frequency is outside of the sweep range, "■" or "■" blinks. After changing the frequency, hold down [F-3] for 1 second to automatically return to the center frequency.
Sweep step display	Displays the selected sweep step. 0.5, 1, 2, 5, 10, 20 and 25 kHz are selectable. Each dot of the band scope display is approximately equal to the selected sweep step.

The band scope measures receive signal location and strength over a specified range on either side of a selected frequency, in either the VFO or memory modes.

- ① Rotate [DIAL] to select a frequency.
- ② Push [MENU] to display the "M1" screen (Menu 1), then push [SCP](F-5) to display the "SCP" screen (Band Scope).
 - Automatically starts sweeping with the previously selected sweeping step.
 - During a sweep, received signals cannot be heard.
- ③ Push [F-5] one or more times to select the desired sweep step.
 - 0.5, 1, 2, 5, 10, 20 and 25 kHz are selectable.
- ④ Push [F-1] to start sweeping, then automatically stop after sweeping.
 - Hold down [F-1] for 1 second to start continuous sweeping. In this case, push [F-1] again to stop the sweeping.
 - During a sweep, "▶ □" is displayed and received signals cannot be heard.
 - If there is a lot of signal noise, turn OFF the Preamplifier to reduce the signal input level, and turn ON the Attenuator to improve the readability of the band scope.
- ⑤ Rotate [DIAL] to find a signal that you wish to communicate with. If you find the signal, communicate in the normal way.
 - If you want to return to the frequency you were using before rotating [DIAL], hold down [F-3] for 1 second.
 - If the selected frequency is set outside of the swept range, "■" or "■" blinks.
- ⑥ If you want to update the band conditions while receiving, repeat steps ③ and ④.

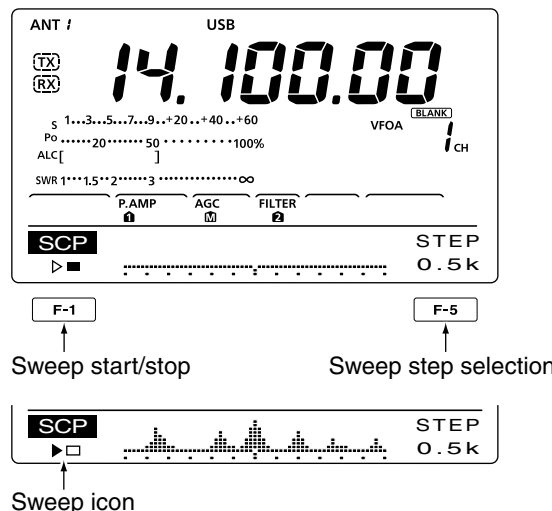

NOTE:
If you select a large sweep step, a wide frequency range can be displayed on the band scope, but some signals may be skipped and not displayed.

■ Preamplifier

The preamplifier amplifies weak signals in the receiver front end, to improve the S/N ratio and sensitivity. Turn this function ON when receiving weak signals.

- Push [P.AMP•ATT] one or more times to set the preamp OFF, preamp 1 ON or preamp 2 ON.
 - Either “P. AMP1” or “P. AMP2” is displayed when the preamp 1 or preamp 2 is ON.
 - No indicator is displayed when the preamp is OFF.

P. AMP1	Wide dynamic range preamplifier. It is most effective for 1.8 to 21 MHz bands.
P. AMP2	High-gain preamplifier. It is most effective for 24 to 50 MHz bands.

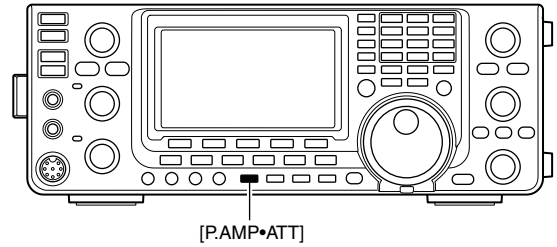

✓ About the “P.AMP2” preamplifier

The preamp 2 is a high gain receive amplifier. When it is used in the presence of strong electromagnetic fields, distortion sometimes results. In such cases, use either the “P.AMP 1” or “P.AMP OFF” setting.

Preamp 2 is most effective when:

- Used on bands above 24 MHz and when signals are weak.
- Receive sensitivity is insufficient when using low-gain antennas, or while using a narrow band antenna.

■ Attenuator

The attenuator prevents a desired signal from being distorted when very strong signals are near the signal’s frequency, or when very strong electromagnetic fields, such as from broadcast stations are near your location.

These can both be independently set for each band.

- Hold down [P.AMP•ATT] for 1 second to turn ON the Attenuator.
 - “ATT” appears when the Attenuator is ON.
- Push [P.AMP•ATT] momentarily to turn OFF it.

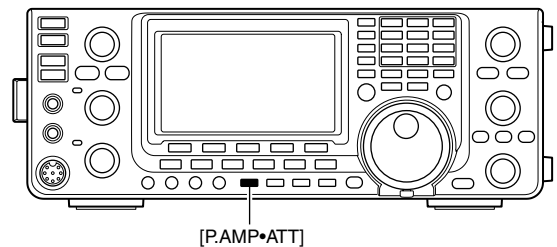

About the Preamplifier and Attenuator switching procedure

The Preamplifier and Attenuator are switched with [P.AMP/ATT], as shown below.

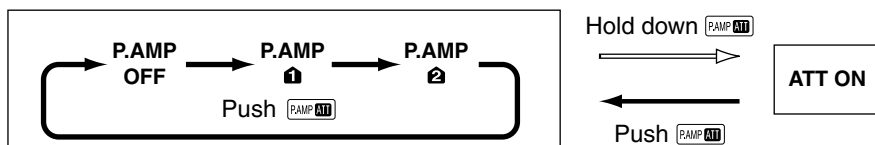

■ AGC function

The AGC (Auto Gain Control) controls receiver gain to produce a constant audio output level, even when the received signal strength varies greatly. The transceiver has three pre-set AGC time constants; fast, mid, and slow for SSB, CW, RTTY and AM modes.

/// In the FM mode, the AGC time constant is fixed to "FAST" (0.1 second).

◇ AGC speed selection

- ① Select either the SSB, CW, RTTY or AM mode. (p. 31)
- ② Push [MENU] to display the "M1" screen (Menu 1), then push [AGC](F-1) one or more times to select AGC fast (F), AGC mid (M) or AGC slow (S).

/// "AGC OFF" appears when the selected AGC speed's time constant is set to OFF.

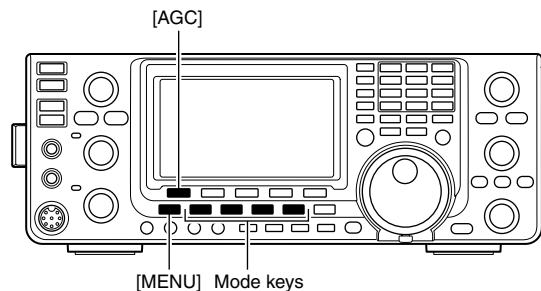

◇ Setting the AGC time constant

- ① Select either the SSB, CW, RTTY or AM mode. (p. 31)
- ② Push [MENU] to display the "M1" screen (Menu 1), then hold down [AGC](F-1) for 1 second to display the "AGC" screen.
- ③ Push either [FAST](F-2), [MID](F-3) or [SLOW](F-4) to select the desired AGC speed to be set.
 - An underline appears below the time constant display.
- ④ Rotate [DIAL] to set the desired time constant.
 - AGC time constant can be set to between 0.1 to 8.0 seconds (depending on the mode) or turned OFF.
 - Hold down [FAST](F-2), [MID](F-3) or [SLOW](F-4) for 1 second to reset to the default setting for the selected time constant.
- ⑤ Select another mode (except for FM), then repeat steps ③ and ④, if desired.
- ⑥ Push [MENU] to save, and exit the "AGC" screen.

• Selectable AGC time constant (unit: seconds)

Mode	Default	Selectable AGC time constant
SSB	0.3 (FAST)	OFF, 0.1, 0.2, 0.3, 0.5, 0.8, 1.2, 1.6, 2.0, 2.5, 3.0, 4.0, 5.0, 6.0
	2.0 (MID)	
	6.0 (SLOW)	
CW/RTTY	0.1 (FAST)	OFF, 0.1, 0.2, 0.3, 0.5, 0.8, 1.2, 1.6, 2.0, 2.5, 3.0, 4.0, 5.0, 6.0
	0.5 (MID)	
	1.2 (SLOW)	
AM	3.0 (FAST)	OFF, 0.3, 0.5, 0.8, 1.2, 1.6, 2.0, 2.5, 3.0, 4.0, 5.0, 6.0, 7.0, 8.0
	5.0 (MID)	
	7.0 (SLOW)	
FM	0.1 (FAST)	Fixed

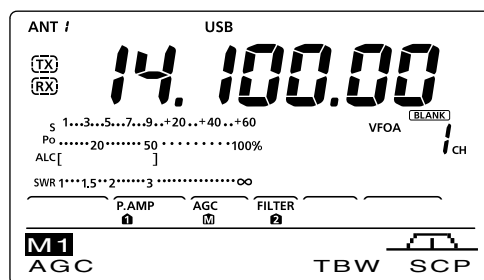

Appears under the selected AGC speed's time constant display. Selected mode

• When AGC fast is selected

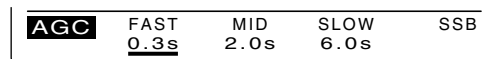

• When AGC slow is selected

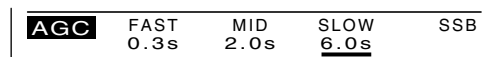

/// For your information

When you are receiving a weak signal, and a strong signal is momentarily received, the AGC function quickly reduces the receiver gain. When that signal disappears, the transceiver may not receive the weak signal because of the AGC action. In that case, hold down [AGC](F-1) for 1 second, and rotate [DIAL] to set the time constant to OFF.

IF filter selection

The transceiver has 3 passband width IF filters for each mode.

- ▨ The filter selection is automatically memorized in each mode.
- ▨ The PBT shift frequencies are automatically memorized in each filter.

IF filter selection

- ① Select the desired mode.
- ② Push [FILTER] one or more times to select IF filter 1, 2 or 3.
 - The selected passband width and filter number is displayed on the LCD.

Filter passband width setting (Mode: SSB/CW/RTTY/AM)

- ① Hold down [FILTER] for 1 second to display the “FIL” screen (Filter) to set the filter passband width.
- ② Select either the SSB, CW, RTTY or AM mode.
 - Passband widths for the FM mode is fixed and cannot be set.
- ③ Push [FILTER] one or more times to select IF filter 1, 2 or 3.
- ④ Push [BW](F-1), then rotate [DIAL] to adjust the desired passband width. Then push [BW](F-1) to set it.
 - While holding down [BW](F-1), rotating [DIAL] also adjusts the passband width. After adjustment, release [BW](F-1) to set it.
 - Hold down [F-3] for 1 second to reset to the default setting, if desired.
- ⑤ Repeat steps ② to ④ if desired.
- ⑥ Push [MENU] to save, and exit the “FIL” screen.

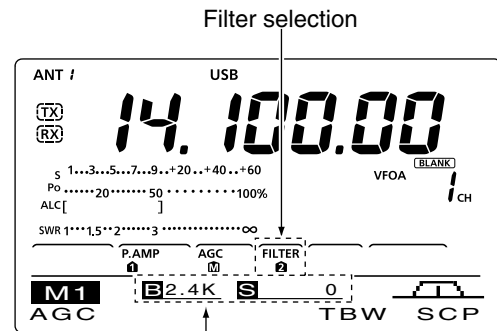
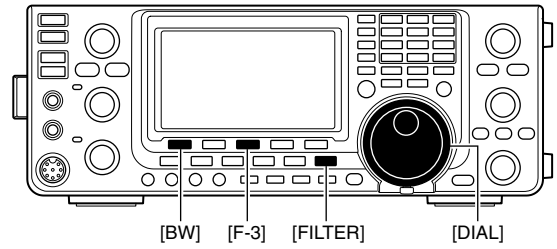

The selected filter width is displayed when [FILTER] is pushed.

“FIL” screen display



Shows the selected filter and passband width.

While adjusting the passband width

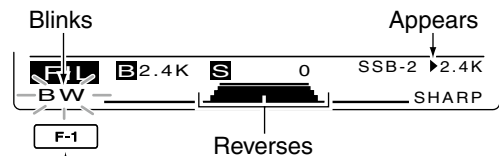

Push [BW](F-1), then rotate [DIAL] to adjust the passband width. Then push [BW](F-1),

Mode	IF filter	Adjustable range (steps)
SSB	FILTER1 (3.0 kHz)	50 to 500 Hz (50 Hz) 600 to 3600 Hz (100 Hz)
	FILTER2 (2.4 kHz)	
	FILTER3 (1.8 kHz)	
SSB-D CW	FILTER1 (1.2 kHz)	50 to 500 Hz (50 Hz) 600 to 3600 Hz (100 Hz)
	FILTER2 (500 Hz)	
	FILTER3 (250 Hz)	
RTTY	FILTER1 (2.4 kHz)	50 to 500 Hz (50 Hz) 600 to 2700 Hz (100 Hz)
	FILTER2 (500 Hz)	
	FILTER3 (250 Hz)	
AM AM-D	FILTER1 (9.0 kHz)	200 Hz to 10 kHz (200 Hz)
	FILTER2 (6.0 kHz)	
	FILTER3 (3.0 kHz)	
FM FM-D	FILTER1 (15 kHz)	Fixed
	FILTER2 (10 kHz)*	
	FILTER3 (7.0 kHz)*	

* When FILTER2 or FILTER3 is selected in the FM mode, the TX modulation changes to the narrow mode (2.5 kHz).

- ▨ The PBT shift frequencies are cleared when the passband width is changed.

- ▨ This “FIL” screen (Filter) graphically displays the PBT shift frequencies and passband width.

◇ 1st IF filter selection

(Mode: SSB/CW/RTTY/AM)

The IC-7410 has a 15 kHz filter passband width at the 1st IF frequency. The 1st IF filters reduce interference from strong nearby signals.

If the optional FL-430 1ST IF FILTER (6 kHz) is installed, a 6 kHz filter width can be used. Or, if the FL-431 1ST IF FILTER (3 kHz) is installed, a 3 kHz filter width can be used.

- ① Hold down [FILTER] for 1 second to display the "FIL" screen (Filter).
- ② Select SSB, CW, RTTY or AM mode.
 - The passband width for the FM mode is fixed.
- ③ Hold down [F-5] for 1 second to select the desired filter width from 15 kHz, 6 kHz and 3 kHz.
 - Hold down [F-3] for 1 second to reset to the default filter setting, if desired. (The filter passband width setting is also reset to the default setting.)
- ④ Push [MENU] to save, and exit the "FIL" screen.

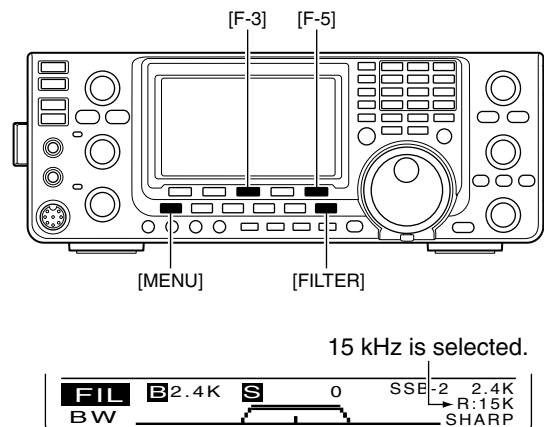

◇ IF (DSP) filter shape

(Mode: SSB/CW)

A soft or sharp type of DSP filter shape for both SSB and CW can be independently selected.

- ① Hold down [FILTER] for 1 second to display the "FIL" screen (Filter).
- ② Select the SSB or CW mode.
- ③ Push [F-5] once or twice to select either the soft or sharp filter shape.
- ④ Push [MENU] to save, and exit the "FIL" screen.

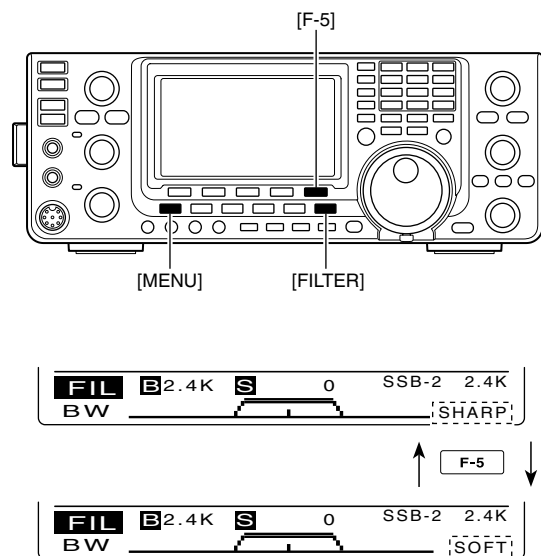

■ Twin PBT operation

(Mode: SSB/CW/RTTY/AM)

To reject interference, PBT (Passband Tuning) electronically narrows the IF passband width by shifting the IF frequency slightly outside of the IF filter passband. The IC-7410 uses DSP for the PBT function. Moving both [TWIN-PBT] controls shift the IF passband center frequency both above and below the received frequency.

- The LCD graphically shows the passband width and frequency shift.
- Hold down [FILTER] for 1 second to display the “FIL” screen (Filter). Current passband width and frequency shift are displayed in the “FIL” screen.
- Hold down [PBT-CLR] for 1 second to set the IF frequency to the center position.
 - The “dot” disappears.

The PBT is adjustable in 50 Hz steps in the SSB, CW and RTTY modes, and 200 Hz in the AM mode. In this time, the shift value changes in 25 Hz steps in the SSB, CW and RTTY modes, and 100 Hz in the AM mode.

- The [TWIN-PBT] controls should normally be set to the center positions when there is no interference. The PBT setting should be cleared.
- When the PBT is used, the audio tone may change.
- The controls do not function in the FM mode.
- While rotating the [TWIN-PBT] controls, noise may occur. This comes from the DSP unit and does not indicate an equipment malfunction.
- Pushing [PBT-CLR] displays the filter passband width and shift value for 2 seconds on the function display.

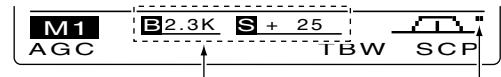
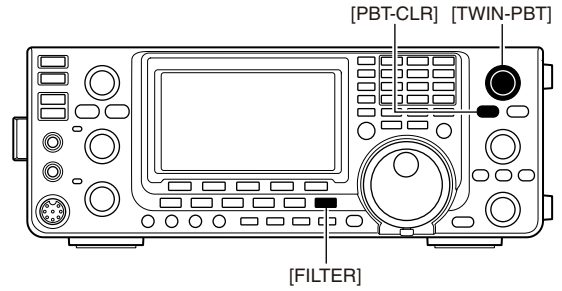

Passband width and shift value are displayed while band is shifted. Appears when pass-band is shifted. [TWIN PBT] is used.

• “FIL” screen (Filter) display

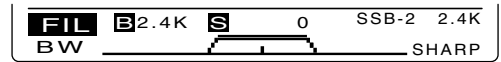

Shows the selected filter and passband width.

• While adjusting the PBT setting

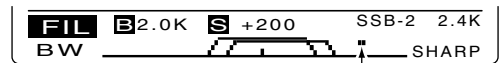

Appears when the passband is shifted.

• About Passband width and Shift value on the screen

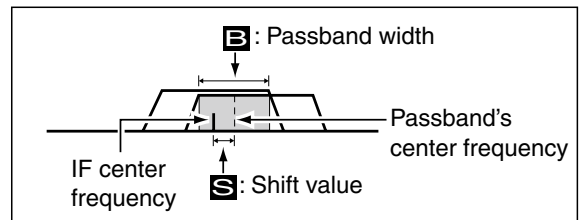

PBT OPERATION EXAMPLE

Both controls in the center positions (or hold down [PBT-CLR] for 1 second.)

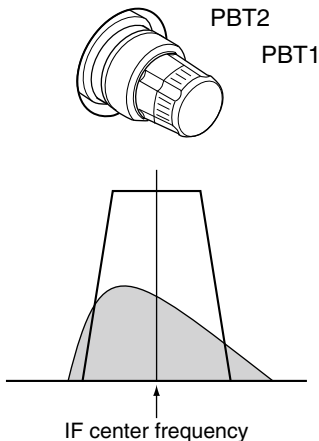

Cutting the lower passband edge

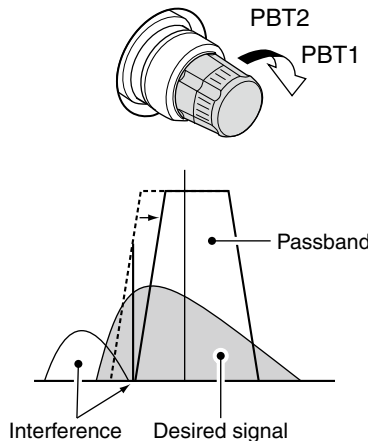

Cutting both lower and higher passband edges

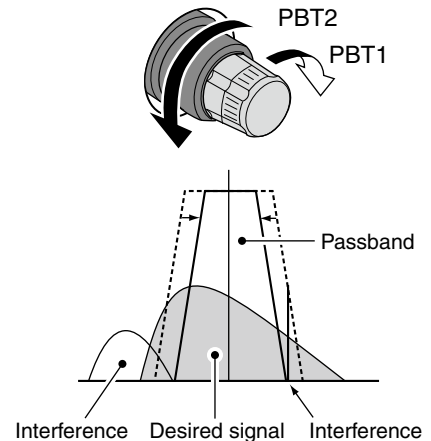

■ Noise Blanker

(Mode: SSB/CW/RTTY/AM)

The Noise Blanker eliminates pulse-type noise such as noise from car ignitions.

- ① Push [NB] to turn ON the Noise Blanker function.
 - “NB” appears.
- ② Rotate the [NB] control to adjust the Noise Blanker threshold level.
- ③ Push [NB] again to turn OFF the function.
 - “NB” disappears.

When using the Noise Blanker function, received signals may be distorted if they are excessively strong or when used for noise other than pulses. In this case, set the Noise Blanker threshold level to a shallow position, or turn OFF the function.

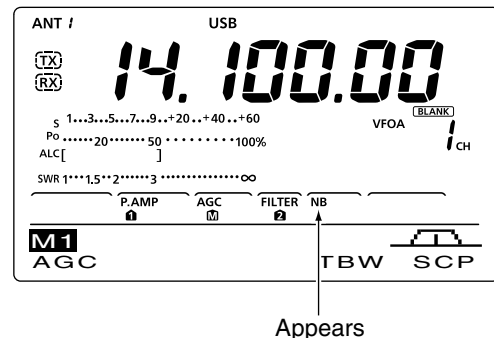
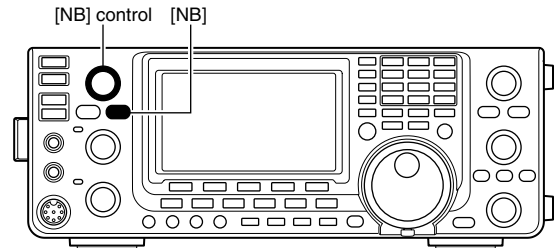

◇ NB Set mode

To deal with various types of noise, the attenuation level and noise blanking duration can be set in the NB Set mode.

- ① Hold down [NB] for 1 second to display the “NB” screen (Noise Blanker).
- ② Push [▲](F-1) or [▼](F-2) to select the desired item.
- ③ Rotate [DIAL] to select the desired option.
 - Hold down [F-3] for 1 second to reset to the default setting, if desired.
- ④ Push [NB] to save and return to the previous screen.

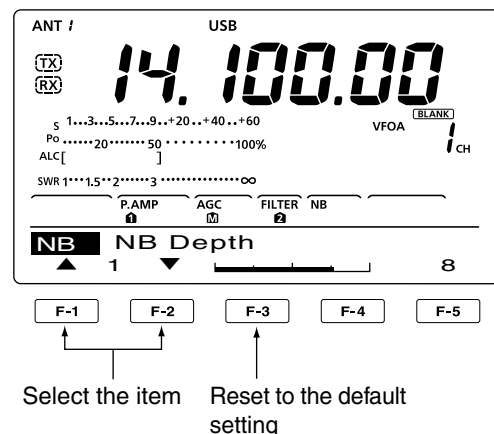

1. NB Depth (Default: 8)

Set the noise attenuation level to between 1 and 10.

2. NB Width (Default: 50)

Set the blanking duration to between 1 and 100.

■ Meter Peak Hold function

When the “Meter Peak Hold” item is set to ON in the Set mode, the peak level of a received signal strength or the output power is displayed for approximately 0.5 seconds. (p. 86).

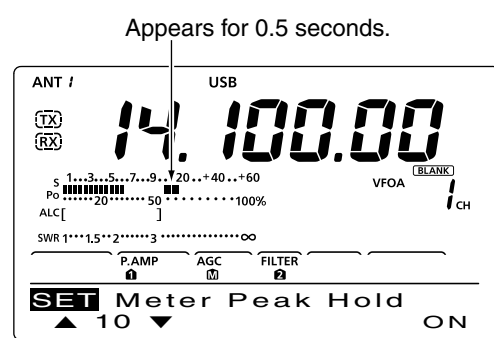

■ Noise Reduction

The Noise Reduction function reduces random noise components and enhances audio signals which are buried in noise. The received signals are converted to digital signals and then the audio signals are separated from the noise.

- ① Push [NR] to turn ON the Noise Reduction function.
 - “NR” appears.
- ② Rotate the [NR] control to adjust the noise reduction level.
- ③ Push [NR] again to turn OFF the function.
 - “NR” disappears.

/// A large rotation of the [NR] control results in audio signal masking or distortion. Set the [NR] control for maximum readability.

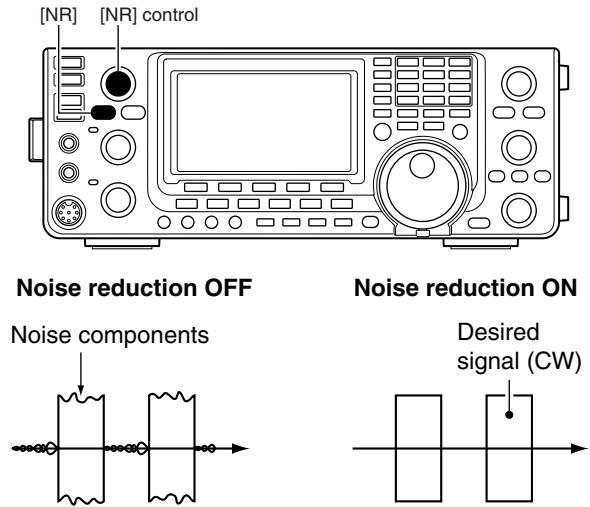

■ Dial Lock function

The Dial Lock function prevents frequency changes by accidental movement of [DIAL] by electronically locking it.

- ➔ Push [LOCK] to turn the Dial Lock function ON or OFF.
 - “” appears when the Dial Lock function is ON.

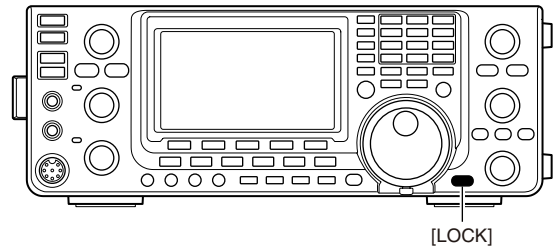

■ Notch function

(Mode = Auto notch : SSB/AM/FM
Manual notch : SSB/CW/RTTY/AM)

This transceiver has Auto and Manual Notch functions. The Auto Notch function uses DSP to automatically attenuate beat tones, tuning signals, etc., even if their frequencies are changing. The Manual Notch function allows you to manually attenuate a frequency via the [NOTCH] control.

- ➔ In the SSB or AM mode, push [NOTCH] to toggle the Notch function between auto, manual and OFF.
 - Either the Auto or Manual Notch function can be disabled in the Set mode. (p. 88)
- ➔ In the CW or RTTY mode, push [NOTCH] to turn the Manual Notch function ON or OFF.
- ➔ In the FM mode, push [NOTCH] to turn the Auto Notch function ON or OFF.
 - “MNF” appears when the Manual Notch function is ON.
 - “ANF” appears when the Auto Notch function is ON.
 - No indicator appears when the notch filter is OFF.
 - When the Manual Notch function is ON, hold down [NOTCH] for 1 second to select the wide, mid, or narrow manual notch filter width.

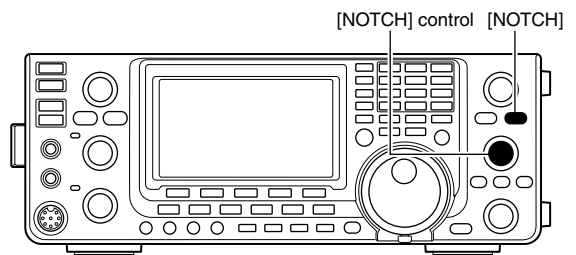

/// While tuning the manual notch filter, noise may be heard. This comes from the DSP unit and does not indicate an equipment malfunction.

■ VOX function

(Mode: SSB/AM/FM)

The VOX (Voice-Operated Transmission) function switches the transceiver between transmit and receive with your voice. This function provides hands-free operation.

◇ Using the VOX function

- ① Select a phone mode (SSB, AM, FM). (p. 31)
- ② Push [VOX/BK-IN] to turn the VOX function ON or OFF.
 - “VOX” appears when the VOX function is ON.

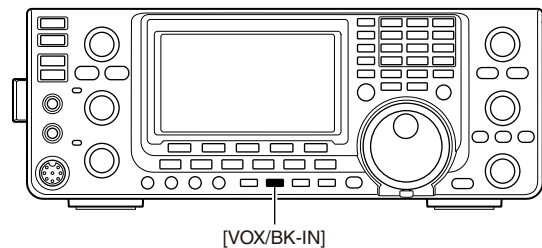

Appears

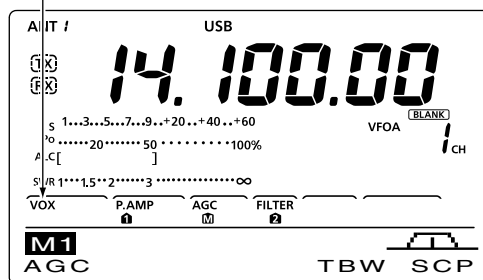

◇ Adjusting the VOX function

- ① Select a phone mode (SSB, AM, FM). (p. 31)
- ② Hold down [VOX/BK-IN] for 1 second to display the “VOX” screen.
- ③ Push [▲](F-1) or [▼](F-2) to select the VOX Gain item.
- ④ While speaking into the microphone, rotate [DIAL] to the point where the transceiver is continuously transmitting.
- ⑤ If the received audio from the speaker causes the VOX circuit to switch to transmit, push [▲] (F-1) or [▼] (F-2) to select the Anti-VOX item. Then adjust the anti-VOX setting to the point where received audio does not activate the VOX.
- ⑥ Adjust the VOX delay for a convenient interval before returning to receive after you stop speaking.
- ⑦ Set the VOX voice delay, if desired.
- ⑧ Push [MENU] to return to the previous menu.

1. VOX Gain (Default: 50%)

Adjust the VOX gain to between 0% and 100%, in 1% steps. Higher values make the VOX function more sensitive to your voice.

2. Anti-VOX (Default: 50%)

Adjust the ANTI-VOX gain to between 0% and 100%, in 1% steps. Higher values make the VOX function less sensitive to the received audio from a speaker or headphones.

3. VOX Delay (Default: 0.2s)

Set the VOX delay to between 0.0 and 2.0 seconds, for normal pauses in speech before returning to receive.

4. VOX Voice Delay (Default: OFF)

Set the VOX voice delay to prevent clipping of the first few syllables of a transmission when switching to transmit.

OFF, Short, Mid and Long settings can be set.

When using the VOX voice delay, turn OFF the TX Monitor function to prevent transmitted audio from being echoed.

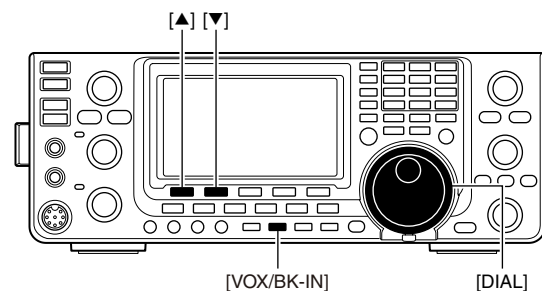

■ Break-in function

(Mode: CW)

The Break-in function is used in the CW mode to automatically toggle the transceiver between transmit and receive when keying. The IC-7410 is capable of Full Break-in or Semi Break-in.

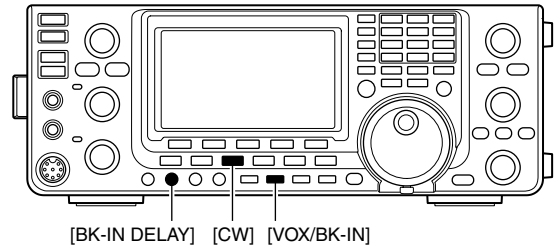

◇ Semi Break-in operation

During Semi Break-in operation, the transceiver immediately transmits when you key down, then returns to receive after a pre-set delay time has passed after you stop keying.

- ① Push [CW] to select the CW or CW-R mode.
- ② Push [VOX/BK-IN] one or more times to turn ON the Semi Break-in function.
 - “BK-IN” appears.
- ③ Rotate the [BK-IN DELAY] control to adjust the break-in delay time (the delay from transmit to receive).

When using a paddle, rotate the [KEY SPEED] control to adjust the keying speed.

Appears

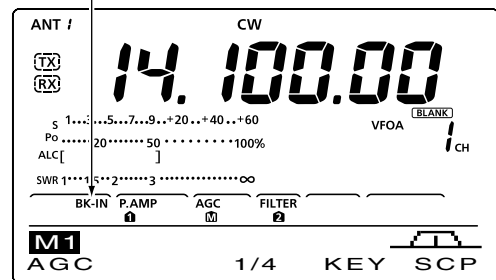

◇ Full Break-in operation

During Full Break-in operation, the transceiver transmits when you key down, then immediately returns to receive when you release.

- ① Push [CW] to select the CW or CW-R mode.
- ② Push [VOX/BK-IN] one or more times to turn ON the Full Break-in function.
 - “FBK-IN” appears.

When using a paddle, rotate the [KEY SPEED] control to adjust the keying speed.

Appears

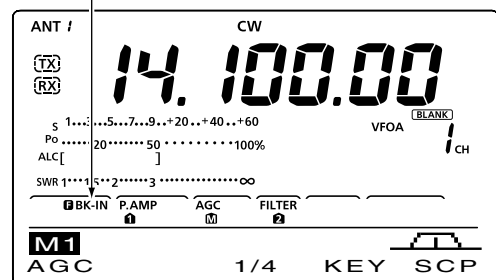

Speech Compressor

(Mode: SSB)

The Speech Compressor function increases average RF output power, improving signal strength and readability.

- ① Push [SSB] to select the USB or LSB mode.
 - ② Rotate the [MIC] control to adjust the microphone gain so the ALC meter reads within the ALC zone, whether or not you speak softly or loudly.
 - ③ Push [COMP] to turn ON the Speech Compressor function.
 - “COMP” appears.
 - ④ While speaking into the microphone at your normal voice level, rotate the [COMP] control to adjust the compressor level so the COMP meter reads within the COMP zone.
 - Hold down [F-3] for 1 second to reset to the default setting, if desired.
- When the COMP meter peaks above the COMP level zone, your transmitted voice may be distorted.

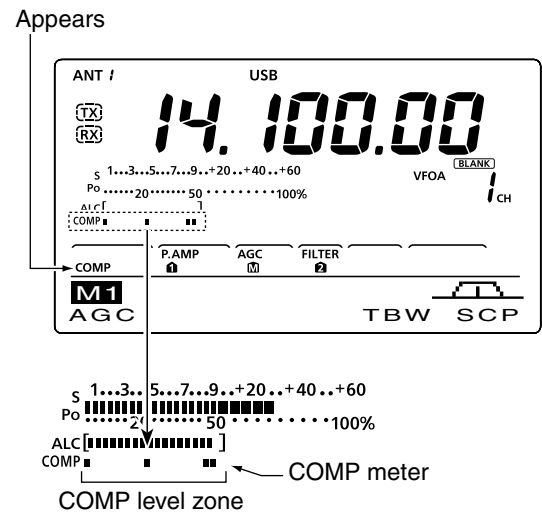
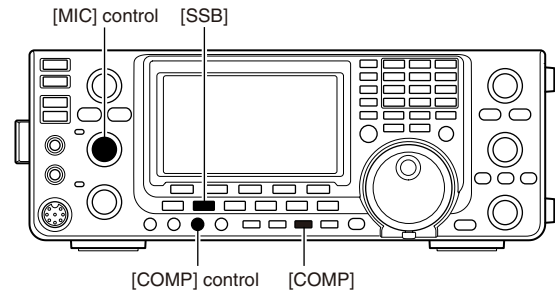

6

Transmit filter width selection

(Mode: SSB)

The transmit filter width for the SSB mode can be set to Wide, Mid or Narrow.

- ① Push [SSB] to select the USB or LSB mode.
- ② Push [MENU] to display the “M1” screen (Menu 1), then hold down [TBW](F-4) for 1 second, one or more times, to select a Wide, Mid or Narrow transmission passband width.
 - Push [TBW](F-4) momentarily to display the selected TX filter width for approximately 1 second.
 - The following filters are specified as the defaults. Each of the filter widths can be set in the Tone Control Set mode. (pp. 90, 91)
 - WIDE : 100 Hz to 2900 Hz
 - MID : 300 Hz to 2700 Hz
 - NAR : 500 Hz to 2500 Hz

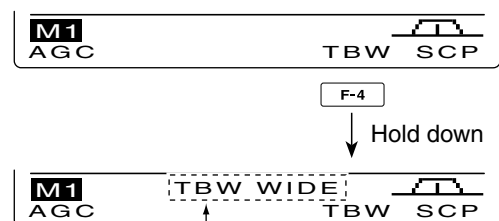
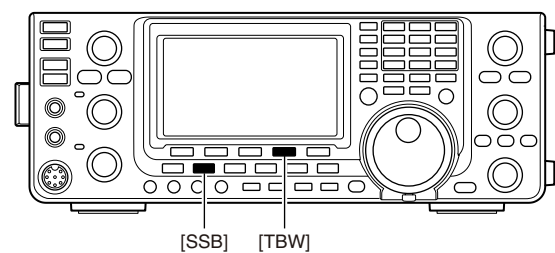

The selected transmit filter width is displayed for approximately 1 second.

■ Δ TX function

The Δ TX function shifts the transmit frequency up to ± 9.99 kHz in 10 Hz steps* without changing the receive frequency.

*The [RIT/ Δ TX] control tunes in 1 Hz steps when the operating frequency readout is set to the 1 Hz step option.

- ① Push [Δ TX] to turn ON the Δ TX function.
 - “ Δ TX” and the frequency shift appear.
- ② Rotate the [RIT/ Δ TX] control.
- ③ To reset the Δ TX frequency, hold down [CLEAR] for 1 second.
 - Push [CLEAR] momentarily to reset the Δ TX frequency when the “Quick RIT Clear” item is set to “ON” in the Set mode. (p. 88)
- ④ To cancel the Δ TX function, push [Δ TX] again.
 - “ Δ TX” and the frequency shift disappear.

When the RIT and Δ TX functions are ON at the same time, the [RIT/ Δ TX] control shifts both the transmit and receive frequencies from the displayed frequency at the same time.

✓ For your convenience— Calculate function

The frequency shift of the Δ TX function can be added to or subtracted from the displayed frequency.

While displaying the Δ TX frequency shift, hold down [Δ TX] for 1 second.

◇ Δ TX Monitor function

When the Δ TX function is ON, holding down [XFC] allows you to directly monitor the transmit frequency (including the Δ TX frequency offset).

■ Monitor function

The Monitor function allows you to listen to your transmit IF signals in any mode. Use this to check voice characteristics while adjusting transmit parameters. (pp. 90, 91)

The CW sidetone functions regardless of the [MONITOR] setting.

- ① Push [MONITOR] to turn ON the Monitor function.
 - “MONI” appears.
- ② Rotate the [MONI GAIN] control to adjust the monitor level.
 - For the clearest audio output, adjust while holding down [PTT] and speaking into the microphone.
- ③ Push [MONITOR] again to turn OFF the function.
 - “MONI” disappears.

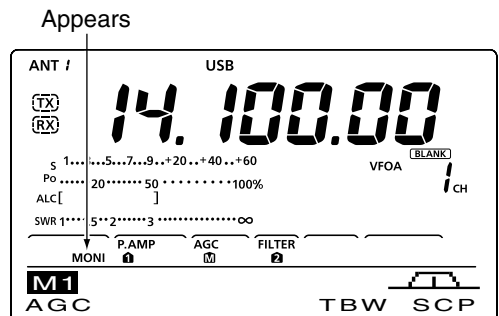
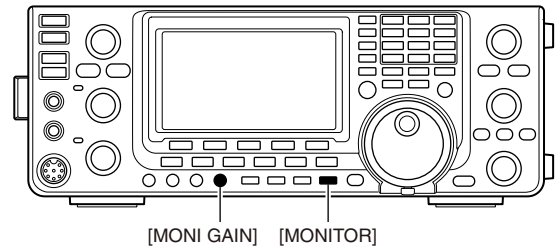
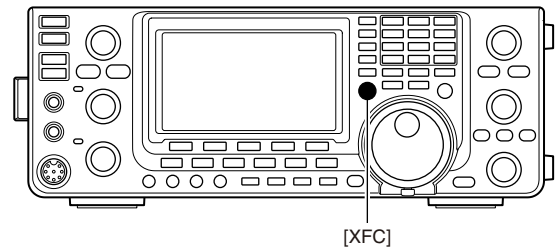
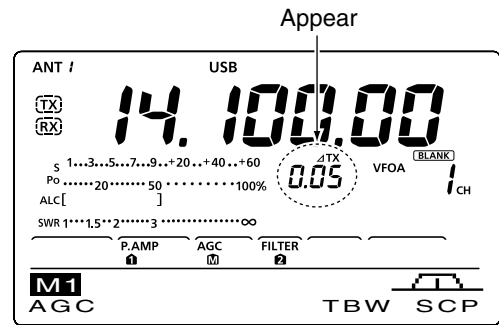
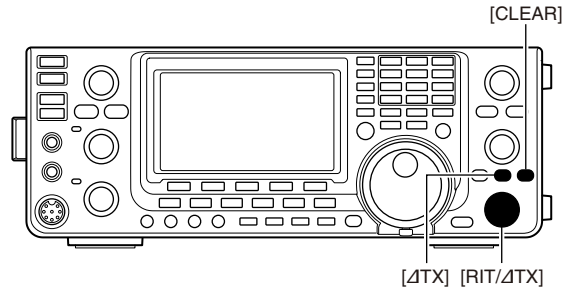

Split frequency operation

Split frequency operation allows you to transmit and receive on two different frequencies. Split frequency operation is performed using frequencies in VFO A and VFO B.

The following is an example of setting 21.290 MHz for receiving and 21.310 MHz for transmitting.

- ① Set 21.290 MHz in VFO A.
- ② Push [SPLIT] to turn ON the Split operation.
 - The transmit (VFO B) frequency and “SPLIT” appear.
- ③ Hold down [A=B] for 1 second to equalize the transmit (VFO B) frequency to the receive (VFO A) frequency.
 - The equalized transmit (VFO B) frequency appears.
 - The Quick Split function is much more convenient for selecting the transmit frequency. See the next section for details.
- ④ While holding down [XFC], rotate [DIAL] to set the transmit frequency to 21.310 MHz.
 - The transmit frequency can be monitored while holding down [XFC].
- ⑤ Now you can receive on 21.290 MHz and transmit on 21.310 MHz.

To change the transmit and receive frequencies, push [A/B] to exchange VFO A and VFO B.

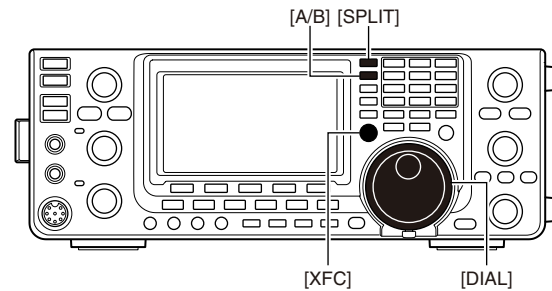

• After pushing [SPLIT]

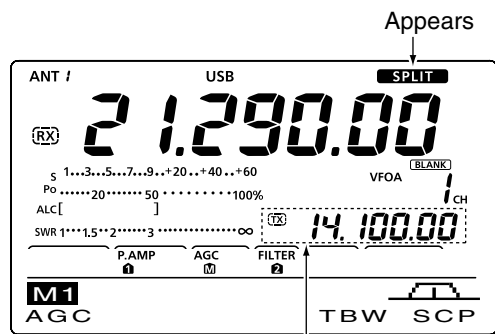

Shows transmit (VFO B) frequency

• While holding down [XFC]

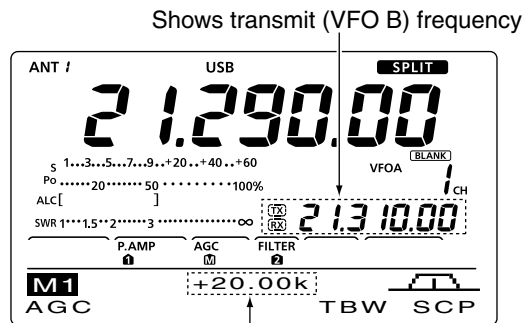

Shows frequency shift and direction

• After setting up

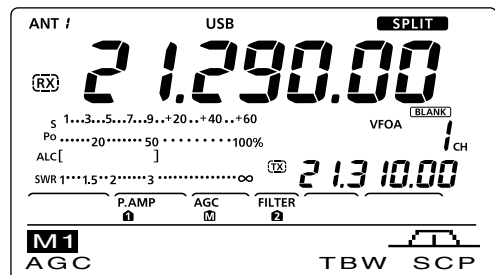

✓ CONVENIENT

• Direct frequency shift input
The frequency shift can be directly entered.

- ① Push [F-INP ENT].
- ② Enter the desired frequency shift with the digit keys.
 - -9.999 to +9.999 MHz can be set. (in 1 kHz steps)
 - When you require a minus shift direction, first push [GENE •].
- ③ Push [SPLIT] to input the frequency shift to the transmit frequency, and the Split function is turned ON.

[Example]
To transmit on a 1 kHz higher frequency:
- Push [F-INP ENT], [1.8 1] then [SPLIT].
To transmit on a 3 kHz lower frequency:
- Push [F-INP ENT], [GENE •], [7 3] then [SPLIT].

• Split Lock function
Accidentally releasing [XFC] while rotating [DIAL] changes the receive frequency. To prevent this, use both the Split Lock and Dial Lock functions to change only the transmit frequency. The Split Lock function cancels the Dial Lock function while holding down [XFC] during split frequency operation. The Split Lock function is OFF by default, but can be turned ON in the Set mode. (p. 86)

■ Quick Split function

When you hold down [SPLIT] for 1 second, the Split frequency operation is turned ON. The undisplayed VFO is automatically changed according to the plus/minus frequency shift programmed in the Set mode, or equalized when 0 kHz (default setting) is programmed as the split frequency shift. (p. 86)

The Quick Split function is ON by default. For your convenience, it can be turned OFF in the Set mode. (p. 86) In this case, holding down [SPLIT] does not equalize the VFO A and VFO B frequencies.

- ① Suppose you are operating at 21.290 MHz (USB) in VFO A.
- ② Hold down [SPLIT] for 1 second.
 - Split frequency operation is turned ON.
 - The transmit frequency (VFO B) is equalized to the receive frequency (VFO A).
 - In the FM mode, the transmit frequency (VFO B) shifts from the receive frequency (VFO A) according to the “FM SPLIT Offset HF” and “FM SPLIT Offset 50” setting in the Set mode.
 - In the FM mode, the Tone Encoder function is automatically turned ON.
- ③ While holding down [XFC], rotate [DIAL] to set the transmit frequency.
 - The frequency shift is displayed on the function display.
 - You can directly set the frequency shift. See the left page for details.

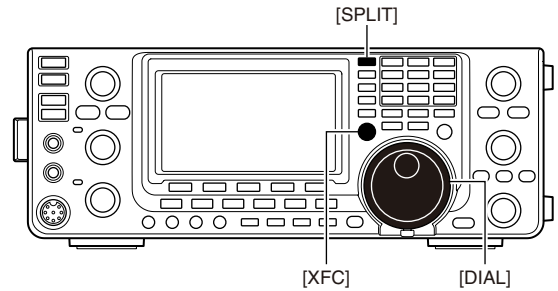

• After holding down [SPLIT]

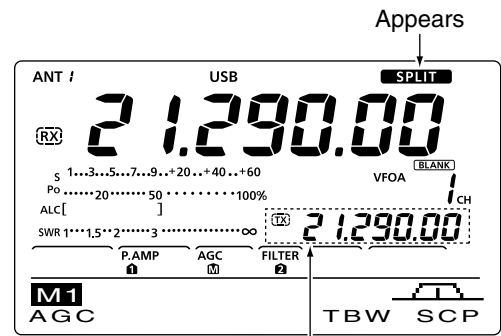

Shows the equalized transmit (VFO B) frequency

◇ Split Lock function

The Split Lock function is convenient for changing only the transmit frequency. When the Split Lock function is not used, accidentally releasing [XFC] while rotating [DIAL], changes the receive frequency.

The Split Lock function is OFF by default. Set the “SPLIT LOCK” item to “ON” in the Set mode. (p. 86)

- ① While split frequency operation is ON, push [LOCK] to turn ON the Split Lock function.
 - “” appears.
- ② While holding down [XFC], rotate [DIAL] to change the transmit frequency.
 - If you accidentally release [XFC] while rotating the [DIAL], the receive frequency does NOT change.

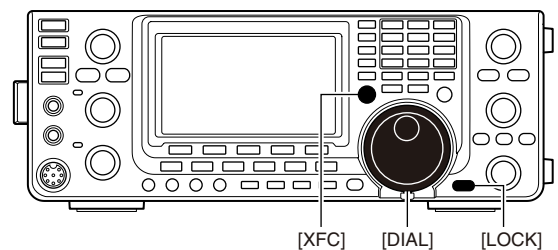

■ Measuring SWR

The IC-7410 has a built-in circuit for measuring antenna SWR— no external equipment or special adjustments are necessary.

The IC-7410 can measure SWR two ways— spot measurement and plot measurement.

◇ Spot measurement

- ① Push [TUNER] once or twice to turn OFF the antenna tuner.
- ② Hold down [ANT•METER] for 1 second, once or twice, to select the SWR meter.
- ③ Push [RTTY] to select the RTTY mode.
- ④ Push [TRANSMIT] on the transceiver, or [PTT] on the microphone to transmit.
- ⑤ Rotate the [RF PWR] control clockwise past the 12 o'clock position for more than 30 W of output power (30%).
- ⑥ Read the SWR on the SWR meter.
- ⑦ Push [TRANSMIT] or release [PTT] to receive.

▨ The built-in antenna tuner matches the transmitter to the antenna only when the SWR is less than 3:1*.
 ▨ *2.5:1 in the 50 MHz frequency band.

◇ Plot measurement

Plot measurement allows you to measure the SWR over an entire band.

- ① Push [MENU] to display the “M2” screen (Menu 2), then push [SWR](F-3).
 - The SWR graph screen appears.
- ② Rotate the [RF PWR] control clockwise past the 12 o'clock position for more than 30 W of output power (30%).
- ③ Set the center frequency for the SWR to be measured.
- ④ Hold down [F-5] for 1 second one or more times to set the SWR measuring step to 10, 50, 100 or 500 kHz.
- ⑤ Push [F-3] one or more times to select the number of measuring steps to 3, 5, 7, 9, 11 or 13.
- ⑥ Push [F-1] to start the measuring.
- ⑦ Push [TRANSMIT] on the transceiver, or hold down [PTT] on the microphone to transmit, to measure the SWR.
 - A frequency marker, “▲,” appears below the SWR graph.
- ⑧ Push [TRANSMIT] again or release [PTT] to move the frequency marker and frequency indication to the next frequency to be measured.
- ⑨ Repeat steps ⑦ and ⑧ to measure the SWR over the entire frequency range.
- ⑩ When the measured SWR is less than 1.5:1, the antenna is well matched with the transceiver in the measured frequency range.

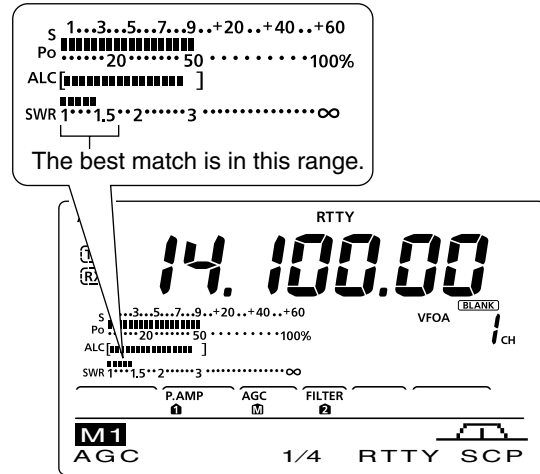

F-3

Push

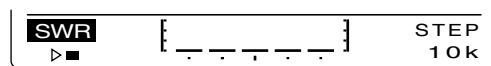

F-1

F-3

F-5

Start measuring
 Select number of SWR measuring steps
 Select SWR measuring step

• Measuring (after pushing [F-1])

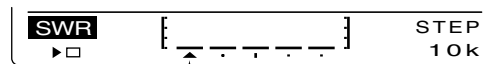

A frequency marker appears and moves after measurement.

When measurement points are set outside of the operable frequency band, the frequency marker blinks.

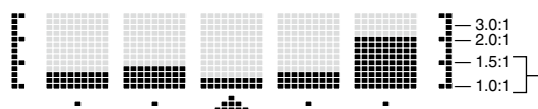

Typical display SWR varying between 1 and 2, full scale up to SWR 4.0:1.

General description

The transceiver has 101 Memory channels (99 regular, and 2 scan edges). The Memory mode is very useful to quickly change to often-used frequencies.

While in the memory mode, all 101 Memory channels are tunable, which means the programmed frequency can be tuned temporarily with [DIAL].

Memory Channels	Descriptions
1–99	Regular Memory channels with Split frequency capability.
P1, P2	Program Scan Edge Memory channels with only Simplex capability. Stores the scan edge frequencies for the programmed scan.

Memory channel contents

The following information can be programmed into Memory channels:

- Operating frequency (p. 26)
- Operating mode (p. 31)
- IF filter number (p. 57)
- Split data (p. 66)
- Memory name (p. 73)
- Repeater tone encoder (p. 51), or tone squelch ON/OFF (p. 50)
- Repeater tone frequency (p. 52) or tone squelch frequency (p. 50)

NOTE:

Memory data can be erased by static electricity, electric transients, etc. In addition, they can be erased by malfunction and during repairs. Therefore, we recommend that memory data be backed up.

Memory channel selection

Selection in the VFO mode

- ① Push [VFO/MEMO] to select the VFO mode.
- ② Push [▲] or [▼] to select a Memory channel number.
 - All Memory channels, including blank channels, can be selected.
 - “BLANK” appears when no information has been programmed into the Memory channel. (Blank channel)
- ③ Push [VFO/MEMO] to select the Memory mode.
 - “MEMO” and contents of the Memory channel appear.

Selection in the Memory mode

- ① Push [VFO/MEMO] to select the Memory mode.
- ② Push [▲] or [▼] to select a Memory channel.
 - All Memory channels, including blank channels, can be selected.
 - “BLANK” appears when no information has been programmed into the Memory channel. (Blank channel)
 - Memory channels can also be selected using the microphone [UP]/[DN] keys. In such case, the blank channels are skipped.

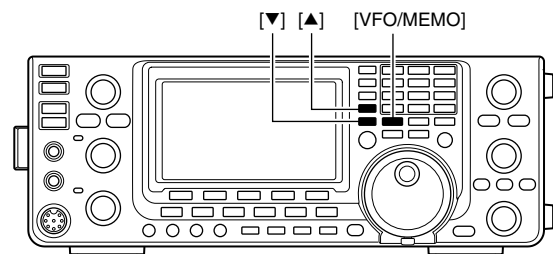

Appears if the selected Memory channel has no information.

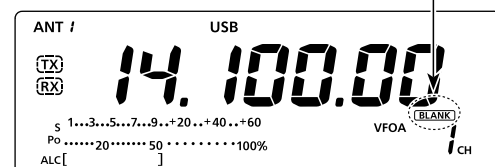

While in the VFO mode

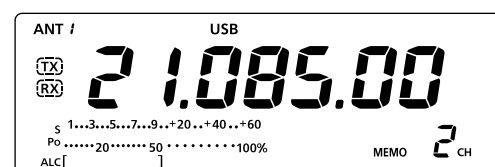

While in the Memory mode

Memory channel programming

Memory channels can be programmed in either the VFO mode or the Memory mode.

◇ Programming in the VFO mode

- ① Push [VFO/MEMO] to select the VFO mode.
- ② Set the frequency, operating mode, and other data into both VFO A and VFO B.
- ③ Push [▲] or [▼] to select a Memory channel number to be programmed.
 - “BLANK” appears if the selected Memory channel is a blank channel.
- ④ Hold down [MW] for 1 second to program the contents into the Memory channel.
 - Three beeps sound when the memory programming is complete.

◇ Programming in the Memory mode

- ① Push [VFO/MEMO] to select the Memory mode.
- ② Push [▲] or [▼] to select a Memory channel to be programmed.
 - The contents of the Memory channel appear in the display.
 - “BLANK” appears if the selected Memory channel is a blank channel.
- ③ Enter the frequency, operating mode, and other data into the Memory channel.
- ④ Hold down [MW] for 1 second to program the contents into the Memory channel.
 - Three beeps sound when the memory programming is complete.

NOTE: If you perform the above operations in a pre-programmed channel, the previous channel data will be overwritten.

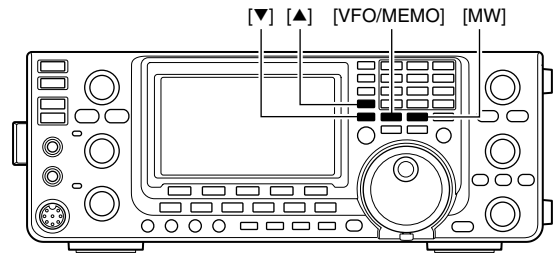

[EXAMPLE]:

Programming 7.088 MHz/LSB into the Memory channel 12 while in the VFO mode.

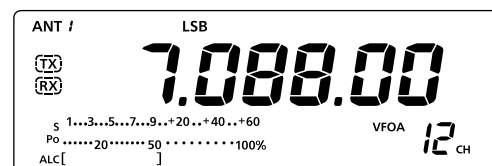

[EXAMPLE]:

Programming 21.280 MHz/USB into Memory channel 18 while in the Memory mode.

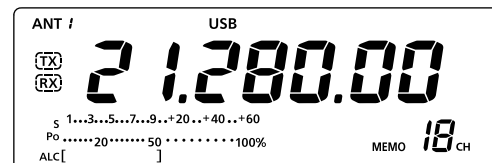

Memory clearing

Any no-longer-used regular Memory channel can be cleared, and then become a blank channel.

- ① Push [VFO/MEMO] to select the Memory mode.
- ② Push [▲] or [▼] to select a regular Memory channel to be cleared.
- ③ Hold down [M-CLR] for 1 second to clear the contents.
 - The programmed contents disappear.
 - “**BLANK**” appears.
 - Three beeps sound when the memory clearing is complete.
- ④ To clear other Memory channels, repeat steps ② and ③.

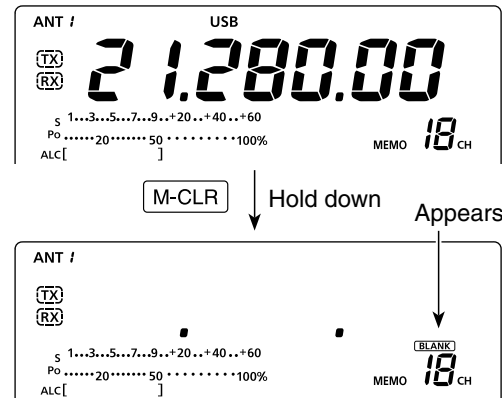
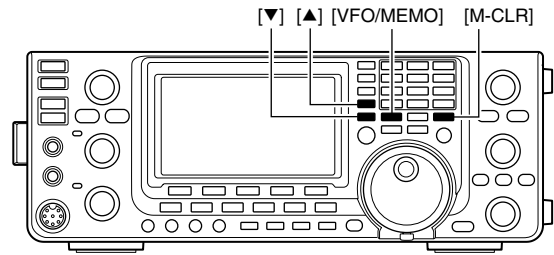

Memory contents copying

The Memory channel contents (frequency, operating mode, etc.) can be copied to the VFO.

The copy can be performed in either the VFO mode or the Memory mode.

Copying in the VFO mode

This is useful for copying programmed contents to a displayed VFO.

- ① Push [VFO/MEMO] to select the VFO mode.
- ② Push [▲] or [▼] to select a Memory channel number to be copied.
 - “BLANK” appears if the selected Memory channel is a blank channel. In this case, nothing can be copied.
- ③ Hold down [VFO/MEMO] for 1 second to copy the Memory channel contents into the VFO.
 - Three beeps sound when the copy is complete.

Copying in the Memory mode

This is useful for copying the Memory channel contents while operating in the Memory mode.

When you have changed the displayed frequency, operating mode, etc. in the selected Memory channel:

- **Displayed** data is copied.
- **Programmed** contents in the Memory channel are not copied, but remain in only the Memory channel.

- ① Push [VFO/MEMO] to select the Memory mode.
- ② Push [▲] or [▼] to select a Memory channel to be copied.
 - “BLANK” appears if the selected Memory channel is a blank channel. In this case, select another channel.
 - Set the frequency or operating mode if required.
- ③ Hold down [VFO/MEMO] for 1 second to copy the Memory channel contents into the VFO.
 - Three beeps sound when the copy is complete.
- ④ Push [VFO/MEMO] to select the VFO mode.

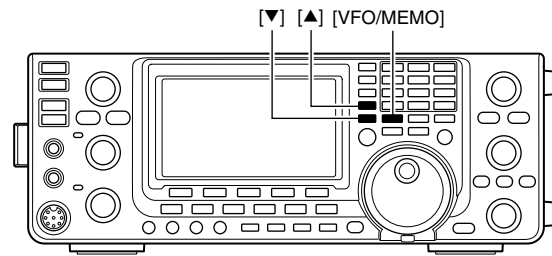

While in the VFO mode

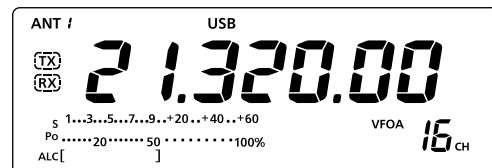

[VFO/MEMO] Hold down

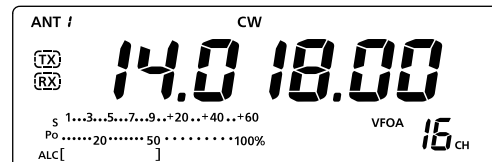

The Memory channel contents are copied

While in the Memory mode

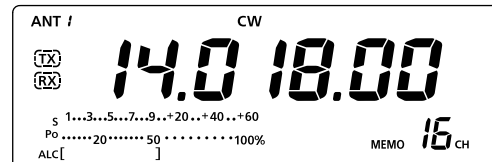

[VFO/MEMO] Hold down

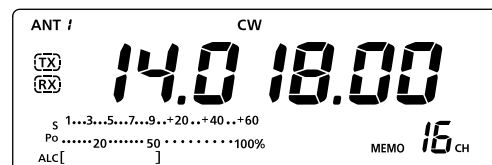

[VFO/MEMO] Push

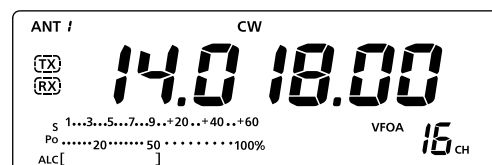

The Memory channel contents are copied

Memory name programming

All Memory channels, including scan edges channels, can be assigned alphanumeric names of up to nine characters each.

[EXAMPLE]: Programming a memory name into Memory channel 99.

- ① Push [VFO/MEMO] to select the Memory mode.
- ② Push [▲] or [▼] to select Memory channel 99.
- ③ Push [MENU] one or more times to display the “M2” screen (Menu 2).
- ④ Push [MEM](F-2) to display the “MEM” screen (Memory Menu).
- ⑤ Push [EDT](F-1) to display the “EDT” screen (Memory Name Edit).
 - A cursor appears and blinks.
 - If the channel you select is a blank channel, an error beep sounds.
- ⑥ Push [F-1] one or more times to select the desired character type.
 - See the “Character table list” below.
- ⑦ Rotate [DIAL] to select the first character to input.
 - When inputting numbers and a decimal point, push the appropriate keypad key.
 - Push [DEL](F-4) to delete the selected character.
 - Push [SPC](F-5) to input a space.
 - An error beep sounds if you try to program more than nine characters. If you want to reprogram the name, push [◀](F-2) or [▶](F-3) to select any undesired character, then push [DEL](F-4) to delete it.
- ⑧ Push [◀](F-2) to move the cursor backward, or push [▶](F-3) to move the cursor forward.
- ⑨ Repeat steps ⑥ to ⑧ to program a memory name of up to 9 characters.
- ⑩ Push [MENU] to save the name, and return to the “MEM” screen.
- ⑪ Push [MENU] again to return to the “M2” screen.

Character table list

Character type	Selectable characters
ABC	A to Z
abc	a to z
etc	! # \$ % & \ ? " ' ` ^ + - * / . , ; = < > () [] { } _ - @

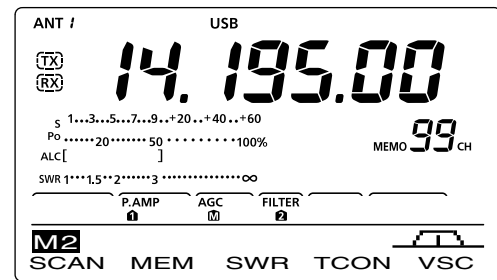
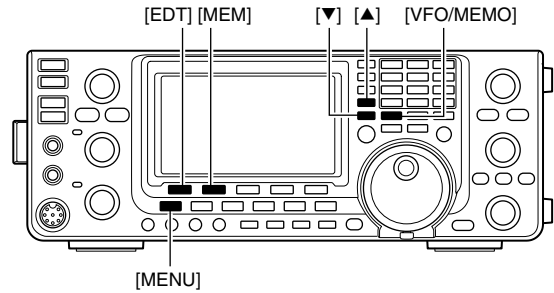

[F-2]

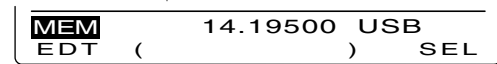

[F-1]



• When programming a memory name

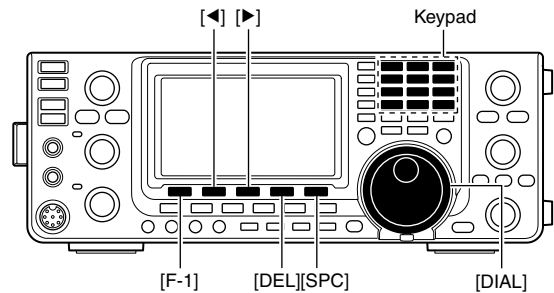

[EXAMPLE]: Programming “DX spot” into Memory channel 99.

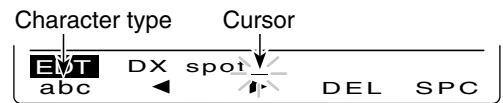

[F-1]

[F-2]

[F-3]

[F-4]

[F-5]

- Input a space
- Delete a character
- Move cursor forwards
- Move cursor backwards
- Select character type

■ Memo Pad function

The transceiver has a Memo Pad function to store the displayed data for easy writing and recalling. The memo pads are separate from the Memory channels. The default number of memo pads is 5. However, you can increase the number to 10 in the “Memopad Numbers” item of the Set mode, if desired. (p. 87)

Memo pads are convenient when you want to memorize the displayed data temporarily, such as when you find a DX station in a pile-up, or when a desired station is busy for a long time and you want to temporarily search for other stations.

Use the transceiver’s memo pads instead of relying on hastily scribbled notes that are easily misplaced.

◇ Writing the displayed data into a memo pad

You can store the displayed data by pushing [MP-W]. When you store the 6th data into memo pads, the oldest stored entry is automatically erased, to make room for the new data.

NOTE: Each memo pad must have its own unique set of data; memo pads having identical data cannot be written.

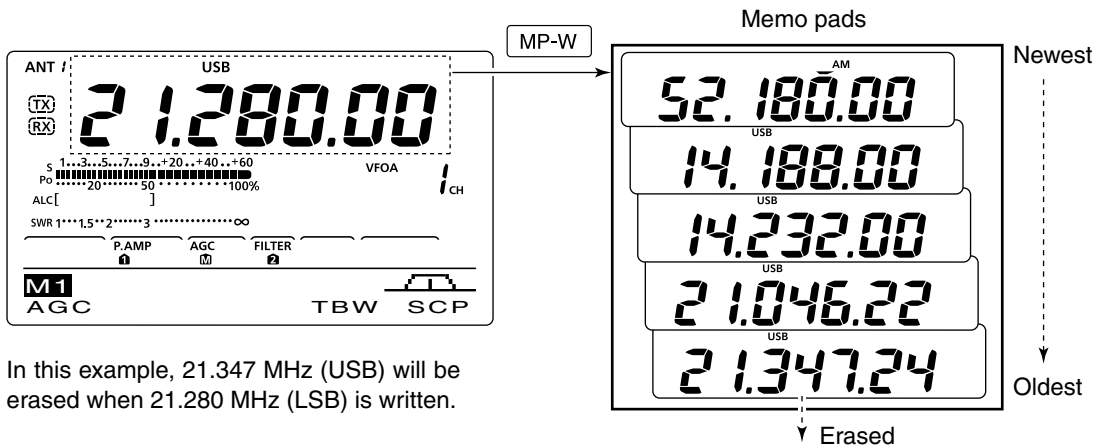

In this example, 21.347 MHz (USB) will be erased when 21.280 MHz (LSB) is written.

◇ Calling up a memo pad

You can call up a memo pad by pushing [MP-R] while in either the VFO or Memory mode.

- The memo pad data is called up, starting from the most recently written.

When you call up a memo pad, the previously displayed data is automatically stored in a temporary pad. The temporary pad can be recalled by pushing [MP-R].

- You may think there are 6 memo pads because 6 different frequencies (5 in memo pads and 1 in the temporary pad) are called up by [MP-R].

If you change the data called up from a memo pad, the stored temporary pad data is replaced with the changed data.

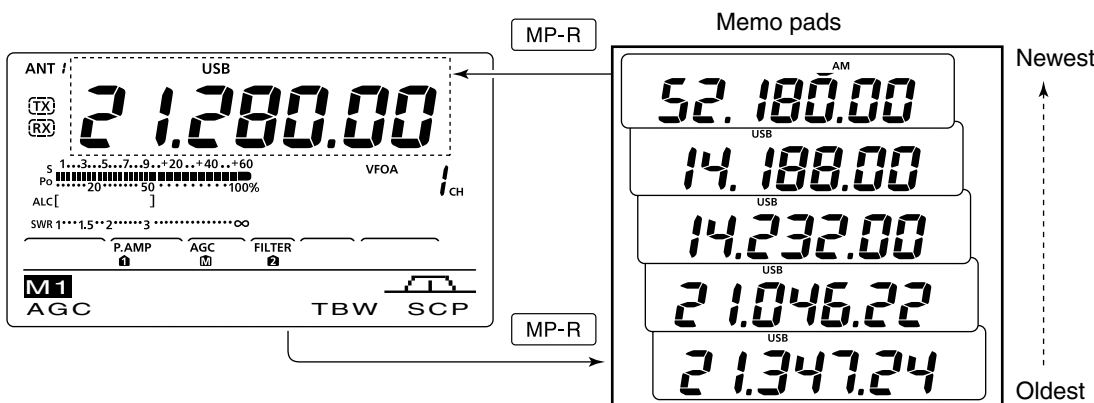

■ Scan types

Scanning automatically searches for signals and makes it easier to locate new stations for contact or listening purposes. The IC-7410 has several scan types; Programmed scan, Memory scan, ΔF (Delta Frequency) scan, and Select Memory scan.

PROGRAMMED SCAN (p. 78)

Repeatedly scans between scan edges (Program Scan Edge channels P1 and P2).

This scan operates in the VFO mode.

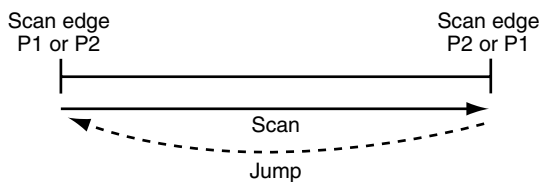

MEMORY SCAN (p. 79)

Repeatedly scans all programmed Memory channels.

This scan operates in the memory mode.

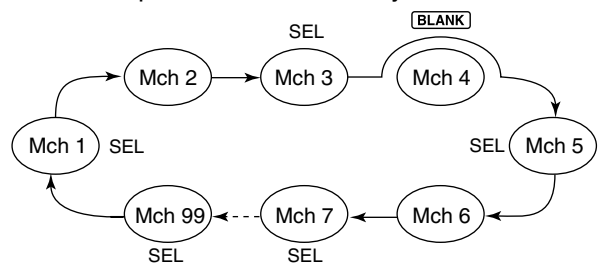

ΔF SCAN (p. 81)

Repeatedly scans within the ΔF span area.

This scan operates in both VFO and memory modes.

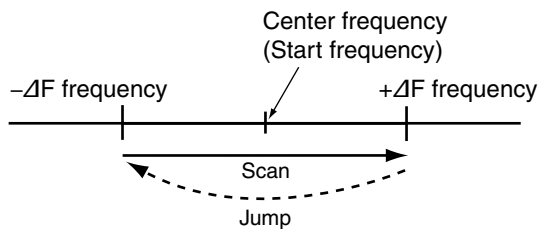

SELECT MEMORY SCAN (p. 80)

Repeatedly scans all Select Memory channels.

This scan operates in the memory mode.

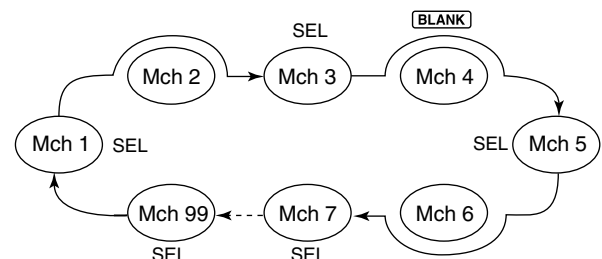

■ Preparation

For a Programmed scan:

Program scan edge frequencies into Program Scan Edge channels “P1” and “P2,” in the same manner as programming Memory channels (p. 70)

For a Memory scan:

Program two or more Memory channels. (Program Scan Edge channels will not be scanned.) (p. 70)

For a Select Memory scan:

Set two or more Memory channels as Select Memory channels. (p. 80)

For a ΔF scan:

Set the ΔF span (ΔF scan range) in the “SCAN” screen. (p. 81)

• Scan Resume function

You can select the scan to resume or cancel, after detecting a signal, in the Scan Set mode. The Scan Resume function must be set before starting a scan. (p. 77)

• Scan speed

The scan speed can be set to high or low, in the Scan Set mode. (p. 77)

• Squelch status

○ The scan starts with the squelch open

For a programmed scan:

When the tuning step is 1 kHz or less:

The scan continues until it is stopped manually—it does not pause*, even if signals are detected.

* The scan is paused when the squelch is closed and then opens. The scan resumes, or is cancelled, depending on the “Scan Resume” setting. (p. 77)

When the tuning step is 5 kHz or more:

If Scan Resume is ON, the scan pauses when a signal is detected, then resumes.

If the Scan Resume is OFF, the scan does not resume.

For a Memory scan:

If Scan Resume is ON, the scan pauses on each channel when a signal is detected, then resumes.

If Scan Resume is OFF, the scan does not start.

○ The scan starts with squelch closed

The scan pauses when signals are detected. The scan resumes, or is cancelled, depending on the “Scan Resume” setting. (p. 77)

■ Voice Squelch Control function

(Mode: SSB/AM/FM)

This function is useful when you do not want unmodulated signals pausing or cancelling a scan. When the Voice Squelch Control (VSC) function is ON, the receiver checks received signals for voice components. The scan pauses, or is cancelled, if a received signal includes voice components, and the tone of the voice components changes within 1 second.

The scan resumes if the received signal includes no voice components, or the tone of the voice components does not change within 1 second.

- ① Push [SSB] or [AM/FM] once or twice to select the operating mode.
- ② Push [MENU] to display the “M2” screen (Menu 2).
- ③ Push [VSC](F-5) to turn the VSC function ON or OFF.
 - “VSC” appears when the VSC function is ON.
 - Push [MENU] to return to the previous display.

- The VSC function is available for phone modes (SSB, AM and FM).
- The VSC function resumes the scan on unmodulated signals, regardless of whether the Scan Resume function is set to ON or OFF.

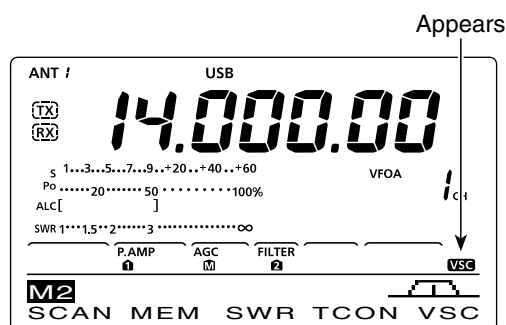
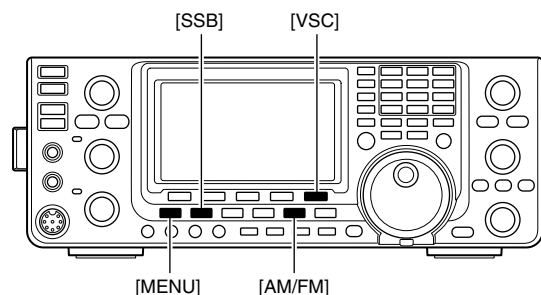

■ Scan Set mode

The scan speed and the Scan Resume function can be set in the Scan Set mode.

- ① Push [MENU] one or more times to display the “M2” screen (Menu 2).
- ② Push [SCAN](F-1) to display the “SCAN” screen.
- ③ Push [SET](F-5) to enter the Scan Set mode.
- ④ Push [▲](F-1) or [▼](F-2) to select the desired item.
- ⑤ Rotate [DIAL] to select the desired option.
 - Hold down [F-3] for 1 second to reset to the default setting.
- ⑥ Push [MENU] to save, and return to the “SCAN” screen.
- ⑦ Push [MENU] again to return to the “M2” screen.

1. SCAN Speed (Default: HIGH)

Select the desired scan speed between high and low.

- HIGH : The scan is faster.
- LOW : The scan is slower.

2. SCAN Resume (Default: ON)

Set the Scan Resume function ON or OFF.

- ON : When a signal is detected, the scan pauses for 10 seconds, then resumes. When a signal disappears, the scan resumes 2 seconds later.
- OFF : When a signal is detected, the scan is cancelled.

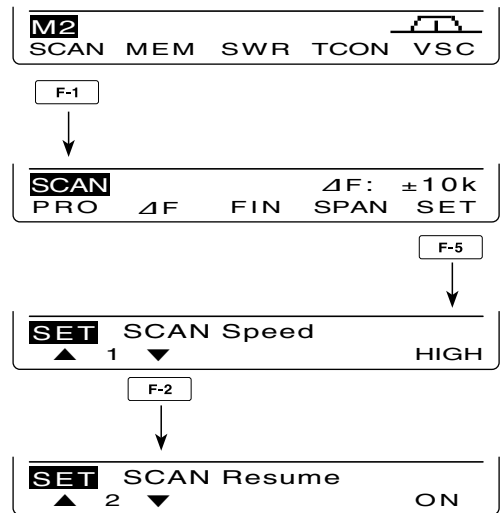
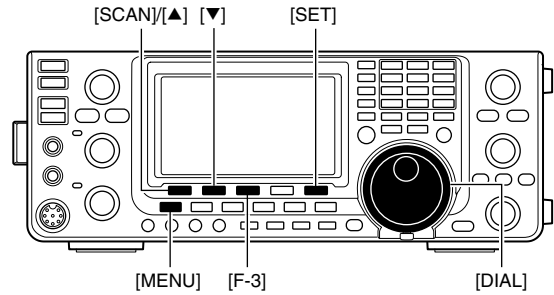

■ Programmed scan/Fine programmed scan (VFO mode)

A programmed scan searches for signals between Program Scan Edge channels “P1” and “P2.”

Before starting the programmed scan, scan edges must be programmed into these channels.

Refer to “■ Memory Channel programming” to program Program Scan Edge channels. (p. 70)

/// If the same frequencies are programmed into the Program Scan Edge channels, the programmed scan will not start.

- ① Push [VFO/MEMO] to select the VFO mode.
- ② Push a mode switch to select the desired operating mode (p.).
 - The operating mode can also be changed while scanning.
- ③ Push [TS] one or more times to select a tuning step. (p. 27)
 - The tuning step can also be changed while scanning.
- ④ Push [MENU] once or twice to display the “M2” screen (Menu 2).
- ⑤ Push [SCAN](F-1) to display the “SCAN” screen.
- ⑥ Rotate the [RF/SQL] control to set the squelch to open or closed.
 - The scan performance differs, depending on the squelch setting when the scan was started. See page 76 for details.
 - If the [RF/SQL] control function is set to “AUTO,” the squelch is always open in the SSB, CW and RTTY modes. (pp. 2, 32, 86)
- ⑦ Push [PRO](F-1) to start or cancel the programmed scan.
 - The MHz and kHz decimal points, and “PROG SCAN” blink while scanning.
 - Rotating [DIAL] also cancels the scan.

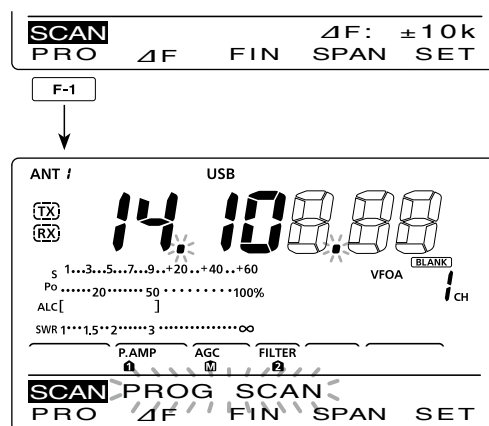
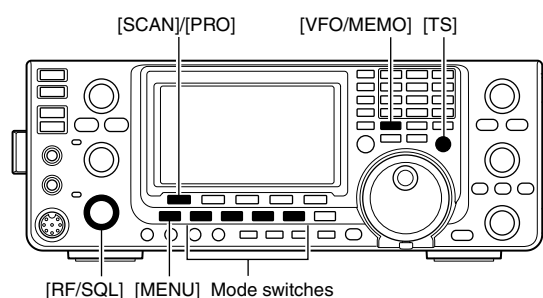

While Programmed scanning

◆ About the Fine programmed scan

When a signal is received during Fine programmed scan, the scanning tuning step is temporarily set to 10 Hz and the scan speed decreases.

- ① Start the programmed scan.
 - Follow steps ① through ⑦ as described above.
- ② While scanning, push [FIN](F-3) to switch the scan function between a programmed scan and a Fine programmed scan.
 - “F-PROG SCAN” blinks while Fine programmed scanning.
- ③ Push [PRO](F-1) to cancel the scan.
 - Rotating [DIAL] also cancels the scan.

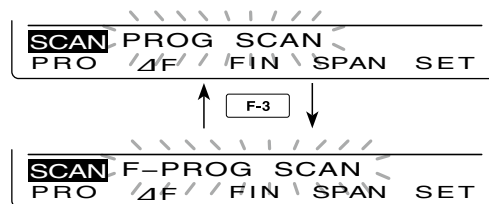

While Fine programmed scanning

■ Memory scan (Memory mode)

◇ Memory scan

A Memory scan searches for signals through Memory channels 1 to 99.

Blank (unprogrammed) channels are skipped.

NOTE: To start a Memory scan, two or more Memory channels must be programmed. (p. 70)

- ① Push [VFO/MEMO] to select the Memory mode.
- ② Push [MENU] to display the “M2” screen (Menu 2).
- ③ Push [SCAN](F-1) to display the “SCAN” screen.
- ④ Rotate the [RF/SQL] control to set the squelch to open or closed.
 - The scan performance differs, depending on the squelch setting when the scan was started. See page 76 for details.
 - If the [RF/SQL] control function is set to “AUTO,” the squelch is always open in the SSB, CW and RTTY modes. (pp. 2, 32, 86)
- ⑤ Push [MEM](F-1) to start or cancel the Memory scan.
 - The MHz and kHz decimal points, and “MEMO SCAN” blink while scanning.
 - Rotating [DIAL] also cancels the scan.

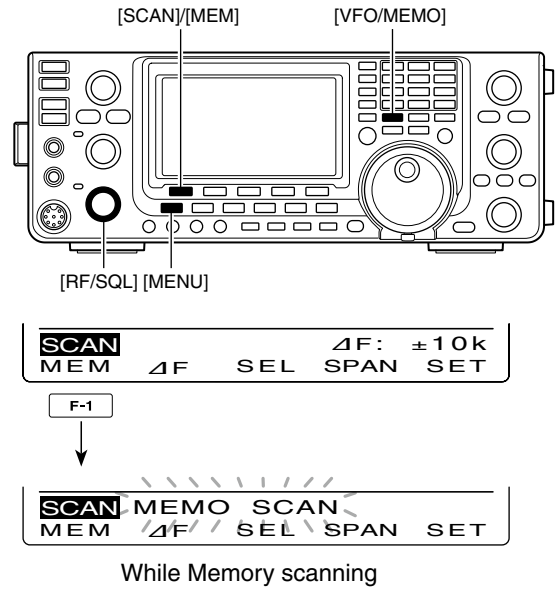

◆ Select Memory scan

Select Memory scan searches for signals through Memory channels programmed as “Sel” (Select).

NOTE: To start a Select Memory scan, two or more Memory channels must be designated as Select Memory channels.

- ① Start a Memory scan.
 - Follow steps ① through ⑤ on the previous page.
- ② While scanning, push [SEL](F-3) to switch the scan function between a Memory scan and a Select Memory scan.
 - “SEL-MEMO SCAN” blinks while Select Memory scanning.
- ③ Push [MEM](F-1) to cancel the scan.
 - Rotating [DIAL] also cancels the scan.

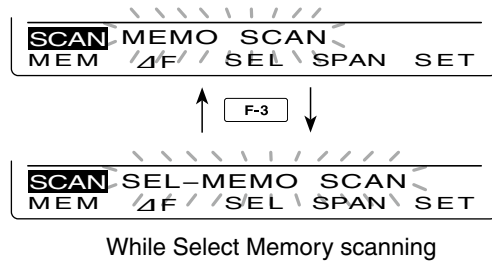

◆ Setting/Cancelling Select Memory channels

All Memory channels can be set as Select Memory channels, except for the Scan Edge channels.

- ➔ When the “SCAN” screen is displayed, push [SEL] (F-3), or when the “MEM” screen (Memory Menu) is displayed, push [SEL](F-5) to set or cancel the displayed Memory channel as a Select Memory channel.
 - “SEL” appears when the channel is set as a Select Memory channel.
 - An error beep sounds when the displayed Memory channel is a blank channel.
 - Holding down [SEL](F-3) or [SEL](F-5) for 1 second displays “SEL ALL Clear?.” Hold down [YES](F-4) to clear all Select Memory channel settings.

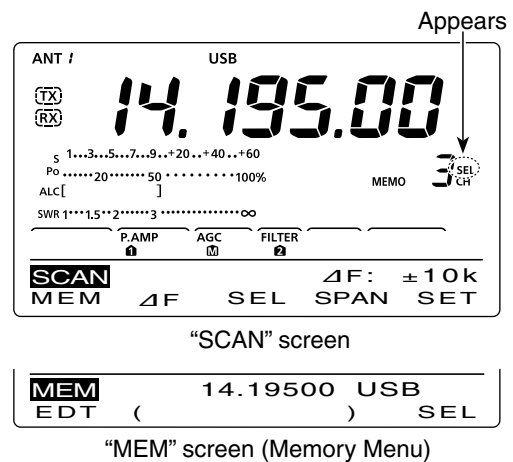

■ ΔF scan and Fine ΔF scan

ΔF (Delta Frequency) scan searches for signals within the specified range with the displayed VFO frequency or Memory channel frequency as the center frequency. The frequency range is specified by the width of the selected span.

- ① Push [VFO/MEMO] once or twice to select the VFO mode or Memory mode.
- ② Push [MENU] one or more times to display the "M2" screen (Menu 2).
- ③ Push [SCAN](F-1) to display the "SCAN" screen.
- ④ Rotate the [RF/SQL] control to set the squelch to open or closed.
 - The scan performance differs, depending on the squelch setting when the scan was started. See page 76 for details.
 - If the [RF/SQL] control function is set to "AUTO," the squelch is always open in the SSB, CW and RTTY modes. (pp. 2, 32, 86)
- ⑤ Push [SPAN](F-4) one or more times to select the desired ΔF span width.
 - ± 5 kHz, ± 10 kHz, ± 20 kHz, ± 50 kHz, ± 100 kHz, ± 500 kHz and ± 1 MHz are selectable.
- ⑥ Set the center frequency of the ΔF scan.
 - In the VFO mode, push the keypad or rotate [DIAL] to set the center frequency.
 - In the memory mode, push \blacktriangle or \blacktriangledown to select the desired Memory channel whose frequency will be the center frequency.
- ⑦ Push [ΔF](F-2) to start or cancel the ΔF scan.
 - " ΔF SCAN," the MHz and kHz decimal points blink while scanning.
 - Rotating [DIAL] also cancels the scan.

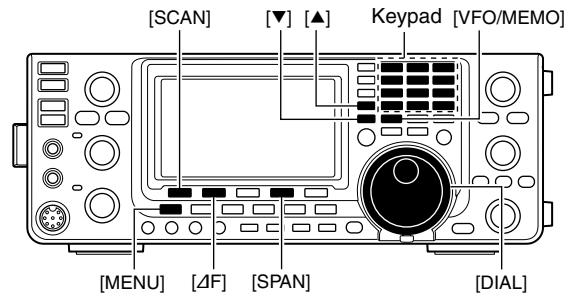

F-4



F-2

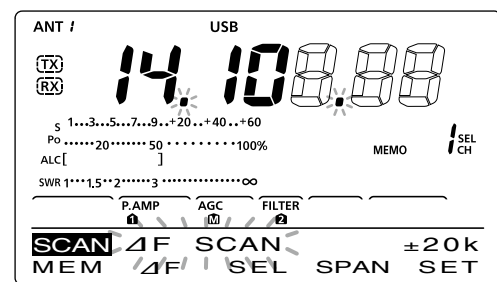

While ΔF scanning

◇ About the Fine ΔF scan

When a signal is received during Fine ΔF scan, the scanning tuning step is temporarily set to 10 Hz and the scan speed decreases.

- ① Start a ΔF scan.
 - Follow steps ① through ⑦ as described above.
- ② While scanning, push [FIN](F-3) to switch the scan function between ΔF scan and Fine ΔF scan.
 - "F- ΔF SCAN" blinks while Fine ΔF scanning.
- ③ Push [ΔF](F-2) to cancel the scan.
 - Rotating [DIAL] also cancels the scan.



F-3



While Fine ΔF scanning

■ Antenna connection and selection

The IC-7410 has 2 antenna connectors for the HF/50 MHz bands, [ANT1] and [ANT2].

You can memorize the antenna for each operating band the IC-7410 covers.

When you change the operating band, the previously set antenna connector for that band is automatically selected. (See below)

This function is especially convenient when you use 2 antennas for HF and 50 MHz band operation.

To use the band memory, set the “[ANT] Switch” item to “Auto” in the Set mode. (p. 87)

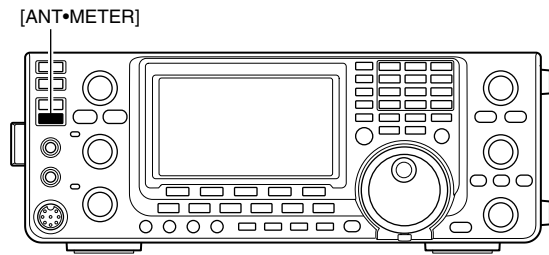

• **Antenna selection mode: “Auto”** (default)

Once an antenna has been selected for use with a band by pushing [ANT•METER], the antenna is automatically selected whenever that band is accessed.

[EXAMPLE]: a 3.5/7 MHz antenna is connected to [ANT1], a 21/28/50 MHz antenna is connected to [ANT2]. When the antenna selector function is set to “Auto,” the correct antenna is automatically selected when you changes bands.

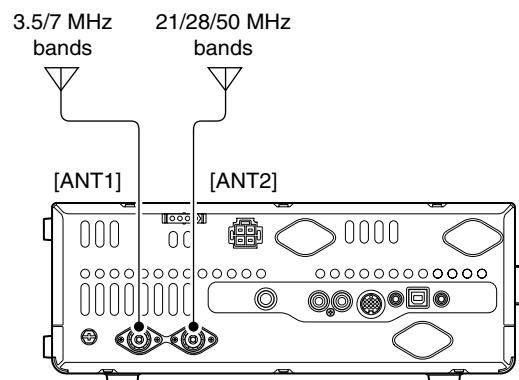

• **Antenna selection mode: “Manual”**

[ANT•METER] functions, however, the band memory function is disabled. In this case, you must select an antenna manually.

[EXAMPLE]: an optional antenna tuner and HF antenna are connected to [ANT1] and a 50 MHz antenna is connected to [ANT2].

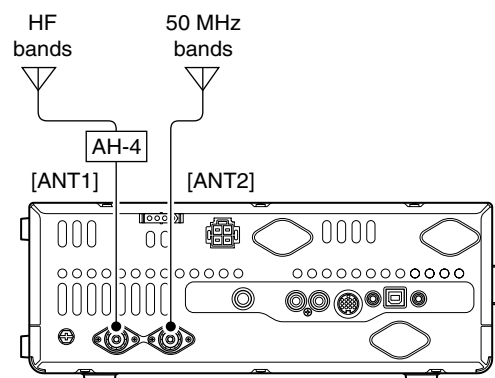

• **Antenna selection mode: “OFF”**

[ANT•METER] does not function. The [ANT1] connector is always selected for HF and 50 MHz bands operation.

■ Antenna tuner operation

The internal automatic antenna tuner automatically matches the transceiver to the selected antenna. After the tuner matches an antenna, the variable capacitor settings are memorized as a preset point for each frequency range (100 kHz steps). Therefore, when you change the frequency range, the variable capacitors are automatically preset to the memorized setting.

CAUTION: NEVER transmit with the tuner ON when no antenna is connected. This will damage the transceiver. Be careful of the antenna selection.

✓ For your convenience

When you purchase a brand-new antenna, or you want to change the antenna settings, you can erase all of the internal antenna tuner preset points with “Tuner Preset Clear” in the Set mode. (p. 87)

◇ Tuner operation

- ➔ Push [TUNER] to turn ON the internal antenna tuner. The antenna is automatically tuned when the antenna SWR is higher than 1.5:1.
 - When the tuner is ON, “**TUNE**” appears.

◇ Manual tuning

If you transmit in SSB with a soft voice, the internal tuner may not automatically tune correctly. In such case, manual tuning is helpful.

- ➔ Hold down [TUNER] for 1 second to start manual tuning.
 - A sidetone sounds, “**TUNE**” blinks and the TX indicator lights red while tuning.
 - If the tuner cannot reduce the SWR to less than 1.5:1 within 20 seconds of tuning, “**TUNE**” disappears and the TX indicator goes out.

NOTES:

- NEVER transmit without an antenna properly connected to each antenna port in use.
- When 2 antennas are connected, select the antenna to be used, by pushing [ANT•METER].
- If the SWR is higher than about 1.5:1 when tuning farther than 100 kHz from an antenna’s programmed preset point, hold down [TUNER] for 1 second to start manual tuning.
- The internal tuner may not be able to tune in the AM mode. In such case, hold down [TUNER] for 1 second to manually tune.

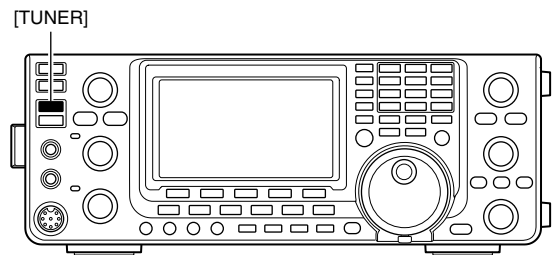

○ If the tuner cannot tune the antenna, check the following and try again:

- the correct antenna connector selection.
- the antenna connection and feedline.
- the untuned antenna SWR. (Less than 3:1 for the HF bands; Less than 2.5:1 for the 50 MHz band)
- the transmit power. (8 W for the HF bands; 15 W for the 50 MHz band)
- the power source voltage/current capacity.

If the tuner still cannot reduce the SWR to less than 1.5:1 after checking the above, perform the following:

- try manual tuning one or more times.
- adjust the antenna feedline length. (This is effective for higher frequencies in some cases.)

Even if manual tuning does not tune the antenna and the tuner turns OFF the first time, it may tune the antenna the second time.

○ Tuning a narrow bandwidth antenna

Some antennas, especially for the low bands, have a narrow bandwidth. These antennas may not be tuned beyond the edge of their operating bandwidth, therefore, manually tune such an antenna as follows:

[Example]: Suppose you have an antenna which has an SWR of 1.5:1 at 3.55 MHz and an SWR of 3:1 at 3.8 MHz.

- ① Select 3.55 MHz and hold down [TUNER] for 1 second. to start manual tuning.
- ② Select 3.80 MHz and hold down [TUNER] for 1 second to start manual tuning.

- **Automatic tuner start (HF bands only)**

If you want to deactivate the tuner when the VSWR is 1.5:1 or less, use the Auto Tuner Start function and turn OFF the tuner. This function activates the tuner automatically when the SWR is high, and is controlled in the Set mode. (p. 86).

- The tuner may not be activated if the TX power output is not stable longer than the specified time period in the SSB or CW mode operation.

- **PTT tuner start**

Tuning of the internal*/external antenna tuner starts when [PTT] is pushed on a new frequency that is more than 1% away from the last-tuned frequency. This function removes the “holding down [TUNER]” operation, and starts tuning on the first transmission on a new frequency.

This function is turned ON in the Set mode. (p. 87).

*Tuning starts if the internal antenna tuner is ON.

■ Optional external tuner operation

- **AH-4 HF/50 MHz AUTOMATIC ANTENNA TUNER**

The optional AH-4 matches the IC-7410 to a long wire antenna more than 7 m/23 ft long (3.5 MHz and above).

- See page 18 for the transceiver and AH-4 connection.
- See the AH-4 instruction manual for AH-4 installation and antenna connection details.

AH-4 setting example:

For mobile operation

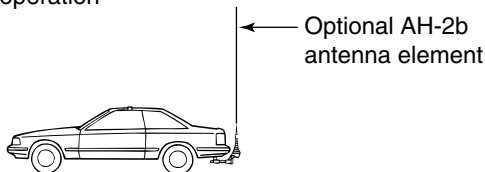

For outdoor operation

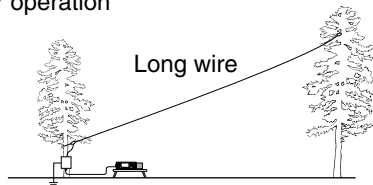

⚠ DANGER: HIGH VOLTAGE!

NEVER touch the antenna element while tuning or transmitting.

CAUTION: NEVER operate the AH-4 without an antenna wire or element. The tuner and transceiver will be damaged.

NEVER operate the AH-4 when it is not grounded.

Transmitting before tuning may damage the transceiver. Note that the AH-4 cannot tune when using a $\frac{1}{2} \lambda$ long wire or multiple of the operating frequency.

When connecting the AH-4, the antenna connector assignments are [ANT2] for the internal tuner and [ANT1] for the AH-4. The antenna icon in the LCD displays “ANT” when the AH-4 is connected and selected.

- **AH-4 operation**

Tuning is required for each frequency. Be sure to re-tune the antenna before transmitting when you change the frequency— even slightly.

- ① Select the desired frequency for use with the AH-4.
 - The AH-4 will not operate on frequencies outside the ham bands.
- ② Hold down [TUNER] for 1 second.
 - “TUNE” blinks while tuning.
- ③ “TUNE” appears constantly when tuning is complete.
 - When the wire antenna cannot be tuned, “TUNE” disappears and the AH-4 is bypassed. At that point the antenna wire connection route is to the transceiver directly, and not via the AH-4 antenna tuner.
- ④ To bypass the AH-4 manually, push [TUNER].

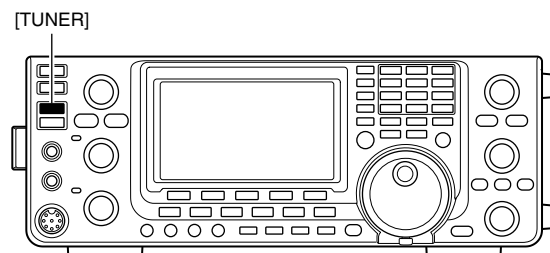

- **Antenna tuner of the IC-PW1/EURO**

When using an external antenna tuner such as that in the IC-PW1/EURO, tune when the internal tuner is turned OFF. After the antenna has been matched, turn ON the internal tuner.

Otherwise, both tuners simultaneously tune, and proper antenna matching may fail.

See the instruction manual included with each antenna tuner for their respective operations.

10 SET MODE

■ Set mode description

The Set mode is used for programming infrequently changed values or functions.

◆ The Set mode settings

- ① Hold down [MENU] for 1 second to enter the Set mode.
- ② Push [▲](F-1) or [▼](F-2) to select the desired item.
- ③ Rotate [DIAL] to select the desired option.
 - Hold down [F-3] for 1 second to reset to the default setting, if desired.
- ④ Push [MENU] to save, and exit the Set mode.

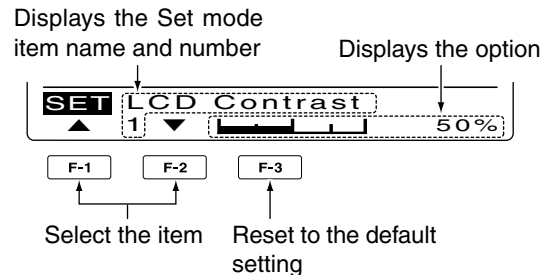
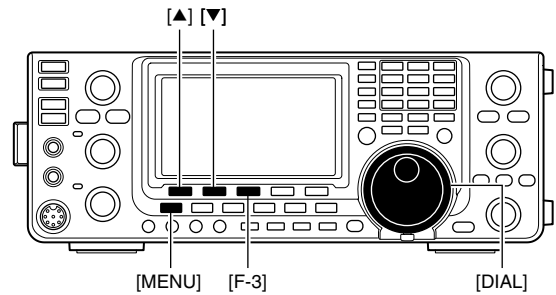

1. LCD Contrast (Default: 50%)

Adjust the LCD contrast to between 0% and 100% in 1% steps.

2. LCD Backlight (Default: 50%)

Adjust the LCD backlight brightness to between 0% and 100% in 1% steps.

NOTE: Regardless of this setting, the LCD backlight brightness is maximum (100%) at power ON by design. (It is not an equipment malfunction.) Then, the brightness level automatically returns to the adjusted value.

3. Beep Level (Default: 50%)

Adjust the confirmation and band edge beep tones output level to between 0% and 100% in 1% steps.

4. Beep Level Limit (Default: ON)

Turn the confirmation and band edge beep tones output level limiting ON or OFF.

When you set this item to ON, the beep tones are adjusted by the [AF] control until rotating the [AF] control reaches to the specified level. Further rotation will not increase the volume of the beep tones.

- OFF : Beep level adjustment is not limited.
- ON : Beep level adjustment is limited with the [AF] control.

5. Beep (Default: ON)

Turn the confirmation beep ON or OFF.
Set the beep output level in the "Beep Level" item, as described to the left.

- OFF : The confirmation beep is OFF. (Silent operation)
- ON : The confirmation beep sounds each time a switch is pushed.

6. Band Edge Beep (Default: ON(Default))

When you tune into or out of an amateur band's frequency range, you can hear a beep tone.
If you select "ON (User)" or "ON (User) & TX," you can program a total of 30 band edge frequencies in the "User band Edge" item.

You can set the beep output level in the "Beep Level" item as described to the left.

- OFF : Band edge beep is OFF
- ON (Default) : When you tune into or out of the default amateur band's frequency range, a beep sounds.
- ON (User) : When you tune into or out of a user programmed amateur band's frequency range, a beep sounds.
- ON (User) & TX : When you tune into or out of a user programmed amateur band's frequency range, a beep sounds. In addition, transmission is inhibited outside the programmed range.

7. User Band Edge

This “User Band Edge” item appears only when “ON (User)” or “User (ON) & TX” is selected in the “Band Edge Beep” item. (p. 85)

When you select “ON (User)” or “ON (User) & TX” in the “Band Edge Beep” item, you can program a total of 30 band edge frequencies in this item. See page 30 for programming details.

8. Beep Sound (Default: 1000Hz)

Set a desired beep frequency for key operation to between 500 Hz and 2000 Hz in 10 Hz steps.

You can set the beep output level in the “Beep Level” item. (p. 85)

9. RF/SQL Control (Default: RF+SQL)

Set the [RF/SQL] control function.

- AUTO : [RF/SQL] functions as only an RF gain control in SSB, CW and RTTY; a squelch control in AM and FM.
- SQL : [RF/SQL] functions as a squelch control.
- RF+SQL : [RF/SQL] functions as an RF gain control as well as a noise squelch or an S-meter squelch in FM; as an RF gain control as well as an S-meter squelch in SSB, CW, RTTY and AM.

10. Meter Peak Hold (Default: ON)

Turn the Meter Peak Hold function ON or OFF.

When this function is set to ON, the peak level of a received signal strength or the output power is displayed for approximately 0.5 seconds.

11. TOT (CI-V) (Default: OFF)

To prevent a prolonged transmission, the transceiver has a Time-Out Timer function.

If a continuous transmission exceeds the set period, the transmission will be cut off.

Set the time period to 3, 5, 10, 20 or 30 minutes, or turn OFF the function.

NOTE: This function will be activated only when you transmit using CI-V commands, or pushing [TRANSMIT] on the transceiver.

12. Quick SPLIT (Default: ON)

Turn the Quick Split function ON or OFF.

When this item is set to ON, hold down [SPLIT] for 1 second to shift the transmit frequency from the receive frequency, according to the “FM SPLIT Offset HF” or “FM SPLIT Offset 50” setting as described below. See page 67 for details.

13. FM SPLIT Offset HF (Default: -0.100MHz)

Set the offset* to use the Quick Split function in the HF bands.

*The difference between transmit and receive frequencies.

The frequency offset can be set to between -9.999 MHz and +9.999 MHz in 1 kHz steps.

14. FM SPLIT Offset 50 (Default: -0.500MHz)

Set the offset* to use the Quick Split function in the 50 MHz bands.

*The difference between transmit and receive frequencies.

The frequency offset can be set to between -9.999 MHz and +9.999 MHz in 1 kHz steps.

15. SPLIT LOCK (Default: OFF)

Turn the Split Lock function ON or OFF.

When this item is set to ON, you can use [DIAL] to adjust the transmit frequency while holding down [XFC], even while the Dial Lock function is ON.

See pages 66, 67 for split frequency operation details.

16. Tuner (Auto Start) (Default: OFF)

Turn the Automatic Antenna Tuner function ON or OFF. This function is for only the HF bands.

- OFF : The internal antenna tuner remains OFF even when the SWR is high.
- ON : The internal antenna tuner automatically starts tuning when the SWR is high, even if the tuner is turned OFF.

■ Set mode description (Continued)

17. Tuner (PTT Start) (Default: OFF)

Whenever you push [PTT], the internal or external antenna tuner automatically starts tuning if the operating frequency is changed by more than 1% from the last-tuned frequency.

- OFF : Tuning starts only when [TUNER] is pushed.
- ON : (Internal antenna tuner) Tuning starts when you push [PTT] on a new frequency, if the internal antenna tuner is ON.
(External antenna tuner) Tuning always starts when you push [PTT] on a new frequency, regardless of whether the external antenna tuner is ON or OFF.

18. Tuner Preset Clear

Select the desired antenna.
The selected antenna's preset memory* is cleared by holding down [CLR](F-4) for 1 second.

*The variable capacitor settings are memorized as a preset point for each frequency range (100 kHz steps) after the tuner matches an antenna.

- CLR ANT1 : The preset memory of [ANT1]'s antenna is cleared.
- CLR ANT2 : The preset memory of [ANT2]'s antenna is cleared.

19. [ANT] Switch (Default: Auto)

Set the antenna switch function to Auto, Manual or OFF. When you change the operating frequency, this function will automatically select the correct antenna, or you must do it manually.

- OFF : [ANT•METER] does not function. The [ANT1] connector is always selected.
- Manual : You must manually change the antenna by pushing [ANT•METER].
- Auto : The antenna memorized by the band memory is automatically selected. You can also manually change the antenna by pushing [ANT•METER].

20. SPEECH Level (Default: 50%)

Adjust the speech audio output level to between 0% (no output) and 100% (maximum output).

21. SPEECH Language (Default: English)

Select English or Japanese as the speech language.

22. SPEECH Speed (Default: HIGH)

Select HIGH (faster) or LOW (slower) speech speed.

23. SPEECH S-Level (Default: ON)

The signal level announcement with the voice synthesizer can be turned ON or OFF.

- OFF : The signal level is not announced. Operating frequency is announced.
- ON : The signal level and the operating frequency are announced.

24. SPEECH [MODE] SW (Default: OFF)

Turn the Operating Mode Speech function ON or OFF.

When this function is ON, the selected operating mode is verbally announced when a mode switch is pushed.

- OFF : The operating mode Speech function is OFF.
- ON : The operating mode Speech function is ON.

25. Memopad Numbers (Default: 5)

Set the number of available memo pads to 5 or 10. See page 74 for details.

26. MAIN DIAL Auto TS (Default: HIGH)

Set the Auto Tuning Step function for [DIAL]. When rapidly rotating [DIAL], the tuning step automatically changes as selected.

There are two types of auto tuning steps: LOW (Faster) and HIGH (Fastest).

- OFF : Auto tuning step is turned OFF.
- LOW : Approximately 2 times faster.
- HIGH : Approximately 5 times faster when the tuning step is set to 1 kHz or smaller steps; approximately 2 times faster when the tuning step is set to 5 kHz or larger steps.

27. MIC Up/Down Speed (Default: HIGH)

Set the rate at which frequencies are scanned while holding down the microphone [UP]/[DN] switches.

- LOW : Low speed (25 tuning steps/second)
- HIGH : High speed (50 tuning steps/second)

28. Quick RIT Clear (Default: OFF)

Select the RIT/ Δ TX frequency offset clearing operation with [CLEAR].

- OFF : Holding down [CLEAR] for 1 second clears the RIT and Δ TX frequency offset.
- ON : Pushing [CLEAR] instantly clears the RIT and Δ TX frequency offset.

29. [NOTCH] SW (SSB) (Default: Auto/Manual)

Select the Auto, Manual or Auto/Manual notch filter to be used for SSB mode operation.

- Auto : Only the Auto notch filter can be used.
- Manual : Only the Manual notch filter can be used.
- Auto/Manual : Both the Auto and Manual notch filters can be used.

30. [NOTCH] SW (AM) (Default: Auto/Manual)

Select the Auto, Manual or Auto/Manual notch filter used for AM mode operation.

- Auto : Only the Auto notch filter can be used.
- Manual : Only the Manual notch filter can be used.
- Auto/Manual : Both the Auto and Manual notch filters can be used.

31. MN-Q Popup (MN ON) (Default: ON)

Turn the manual notch filter width display ON or OFF. When this item set to ON, and the manual notch filter is selected with [NOTCH], the manual notch filter width appears on the function display.

32. BW Popup (PBT) (Default: ON)

Turn the IF filter passband width and shift value display ON or OFF. When this item set to ON, and the [TWIN PBT] control is rotated, the passband width and shifting value appear on the function display.

33. BW Popup (FIL) (Default: ON)

Turn the IF filter passband width and shift value display ON or OFF. When this item set to ON, and [FILTER] is pushed, the passband width and shifting value appear on the function display.

34. SSB/CW Sync Tuning (Default: OFF)

Turn the Displayed Frequency Shift function ON or OFF. When this function is turned ON, the audio pitch or tones of the received signal will remain the same, even when the operating mode is changed between SSB and CW. The amount of frequency shift may differ, depending on the CW pitch setting.

- OFF : The displayed frequency does not shift.
- ON : The displayed frequency shifts when the operating mode is changed between SSB and CW.

35. CW Normal Side (Default: LSB)

Select the sideband used to receive CW in the CW normal mode between LSB and USB.

36. KEYER 1st Menu (Default: KEYER-Root)

In the CW mode, select KEYER-Root or KEYER-SEND as the menu that appears first after pushing [KEY](F-4) in the "M1" screen (Menu 1).

- KEYER-Root : Memory keyer menu appears first.
- KEYER-SEND : Keyer SEND menu appears first.

37. External Keypad (Default: OFF)

Turn the external keypad ON or OFF for keyer memory transmission.

See page 18 for the equivalent circuit of an external keypad and connection.

- OFF : The external keypad does not function.
- KEYER SEND : In the CW mode, pushing one of external keypad switches transmits the desired keyer memory contents.

■ Set mode description (Continued)

38. USB Audio SQL (Default: OFF(OPEN))

Select whether or not to output the audio from the [USB] connector on the rear panel, according to the squelch state.

The same audio signals are sent from the [USB] connector and the [ACC] sockets.

- The beep tones and the voice synthesizer announcements are not sent.
- The received audio output level cannot be adjusted with the [AF] control.

- OFF (OPEN) : The received audio is always sent, regardless of the squelch state.
- ON : The received audio is sent when the squelch is open.

39. USB MOD Level (Default: 50%)

Set the input modulation level of the [USB] connector to between 0% and 100% in 1% steps.

40. DATA OFF MOD (Default: MIC,ACC)

Select the desired connector(s) for data modulation input in the data OFF mode.

- MIC : Use the signals from [MIC].
- ACC : Use the signals from [ACC] (pin 11).
- MIC, ACC : Use the signals from [MIC] and [ACC] (pin 11).
- USB : Use the signals from [USB].

41. DATA MOD (Default: ACC)

Select the desired connector(s) for data modulation input in the data mode.

- MIC : Use the signals from [MIC].
- ACC : Use the signals from [ACC] (pin 11).
- MIC, ACC : Use the signals from [MIC] and [ACC] (pin 11).
- USB : Use the signals from [USB].

42. CI-V Baud Rate (Default: Auto)

Set the CI-V data transfer rate between 300, 1200, 4800, 9600, 19200 bps and "Auto."

When "Auto" is selected, the baud rate is automatically set according to the data rate of the connected controller.

43. CI-V Address (Default: 80h)

To distinguish equipment, each CI-V transceiver has its own Icom standard address in hexadecimal code.

The IC-7410's address is 80h.

When 2 or more IC-7410's are connected to an optional CT-17 CI-V level converter, rotate [DIAL] to select a different address for each IC-7410; the range is 01h to DFh.

44. CI-V Transceive (Default: ON)

Turn the transceive operation using the CI-V system ON or OFF.

When this item is set to ON, changing the frequency, operating mode, etc. on the IC-7410 automatically changes those settings on other Icom HF transceivers or receivers, and vice versa.

- OFF : Transceive operation OFF
- ON : Transceive operation ON

45. USB Serial Func (Default: CI-V)

Select the function for the USB port on the rear panel.

- CI-V : Used to send CI-V commands.
- RTTY : In the RTTY mode, used to send RTTY decoded signal.

46. RTTY Decode Baud (Default: 9600)

Set the RTTY decode monitor speed to 300, 1200, 4800, 9600 or 19200 bps.

47. Calibration Marker (Default: OFF)

Use as a simple frequency check of the transceiver. See page 98 for calibration procedure.

/// **NOTE:** Turn OFF the calibration marker after checking the frequency of the transceiver.

- OFF : Calibration marker OFF
- ON : Calibration marker ON

48. REF Adjust

During frequency calibration, set the internal reference frequency to between 0% and 100% range in 1% steps.

/// **NOTE:** The default setting is different for each transceiver.

■ Tone Control Set mode description

◇ The Tone control Set mode settings

- ① Push [MENU] one or more times to display the “M2” screen (Menu 2).
- ② Push [TCON](F-4) to enter the Tone control Set mode.
- ③ Push a mode switch to select the desired operating mode.
- ④ Push [▲](F-1) or [▼](F-2) to select the desired item.
 - Selectable items differ, depending on the operating mode.
- ⑤ Rotate [DIAL] to select the desired option.
 - You can select the option for each operating mode.
 - Hold down [F-3] for 1 second to reset to the default setting, if desired.
- ⑥ Push [MENU] to save, and exit the Set mode.

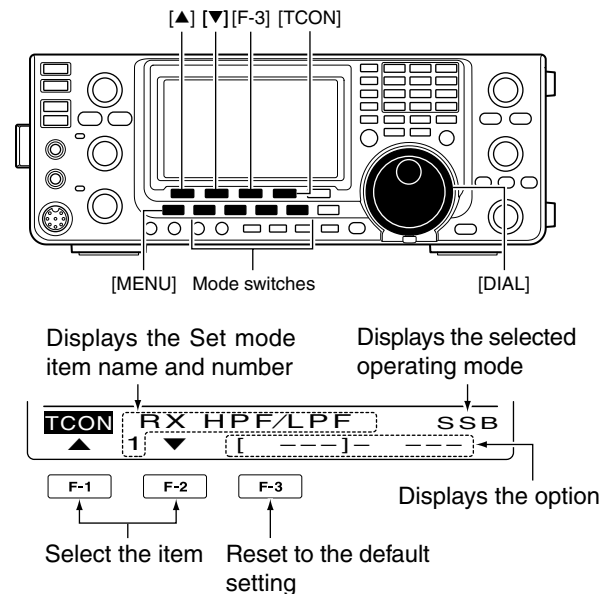

1. RX HPF/LPF (Default: OFF) (Mode: SSB/CW/RTTY/AM/FM)

First select the operating mode, then set the receive audio high-pass filter to between 100 Hz and 2000 Hz in 100 Hz steps.

2. RX HPF/LPF (Default: OFF) (Mode: SSB/CW/RTTY/AM/FM)

First select the operating mode, then set the receive audio low-pass filter to between 500 Hz and 2400 Hz in 100 Hz steps.

3. RX Bass (Default: 0) (Mode: SSB/AM/FM)

First select the operating mode, then set the receive audio bass level to between -5 and +5.

4. RX Treble (Default: 0) (Mode: SSB/AM/FM)

First select the operating mode, then set the receive audio treble level to between -5 and +5.

5. TX Bass (Default: 0) (Mode: SSB/AM/FM)

First select the operating mode, then set the transmit audio bass level to between -5 and +5.

6. TX Treble (Default: 0) (Mode: SSB/AM/FM)

First select the operating mode, then set the transmit audio treble level to between -5 and +5.

7. TBW(WIDE) L (Default: 100) (Mode: SSB)

Set the lower cut-off frequency of the transmission passband width for your wide setting to 100, 200, 300 or 500 Hz.

8. TBW(WIDE) H (Default: 2900) (Mode: SSB)

Set the higher cut-off frequency of the transmission passband width for your wide setting to 2500, 2700, 2800 or 2900 Hz.

NOTE:

- When the receive audio high-pass or low-pass filter is active, “RX Bass” and “RX Treble” items will be reset to the default value.
- When the receive audio bass or receive audio treble level is set, “RX HPF/LPF” items (1 and 2) will be turned OFF.

■ Tone Control Set mode description (Continued)

9. TBW(MID) L (Default: 300)

(Mode: SSB)

Set the lower cut-off frequency of the transmission passband width for your mid setting to 100, 200, 300 or 500 Hz.

10. TBW(MID) H (Default: 2700)

(Mode: SSB)

Set the higher cut-off frequency of the transmission passband width for your mid setting to 2500, 2700, 2800 or 2900 Hz.

11. TBW(NAR) L (Default: 500)

(Mode: SSB)

Set the lower cut-off frequency of the transmission passband width for your narrow setting to 100, 200, 300 or 500 Hz.

12. TBW(NAR) H (Default: 2500)

(Mode: SSB)

Set the higher cut-off frequency of the transmission passband width for your narrow setting to 2500, 2700, 2800 or 2900 Hz.

■ Connections

◇ When connecting to [ACC]

• When using a PC application

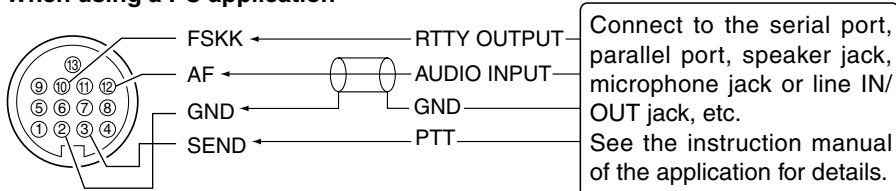

• When using a TNC

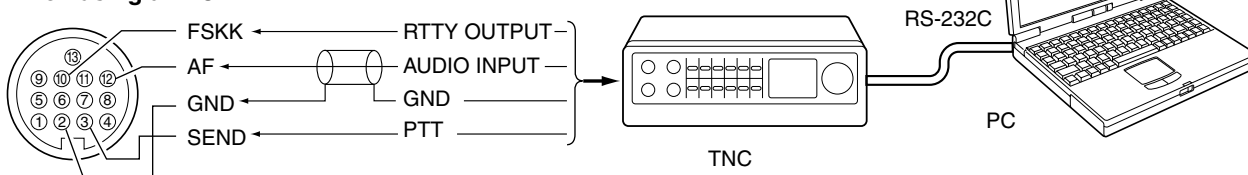

Rear panel view

◇ When connecting to [MIC]

• When using a PC application

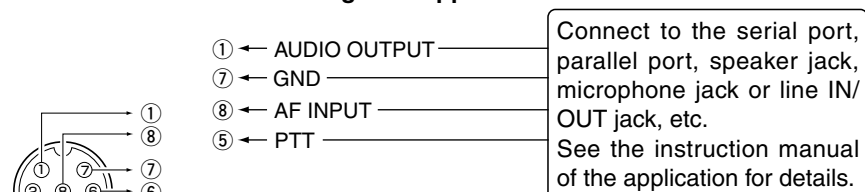

• When using a TNC

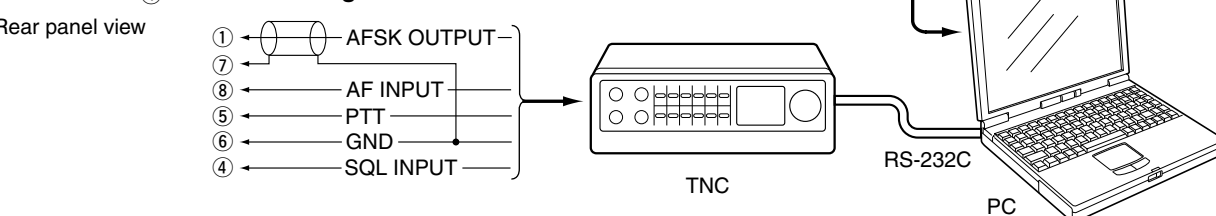

Rear panel view

*1 When using the VOX function, no connection is needed. Refer to the instruction manual of the external equipment.

*2 When connecting the squelch line, consult the necessary manual.

INFORMATION!

When the "USB Serial Func" item is set to "RTTY" in the Set mode (p. 89), the USB port sends RTTY decode signal. In this case, you must connect a USB cable* between the transceiver's USB port on the rear panel and the PC. (p. 17)

• The USB driver and the installation guide can be downloaded from our website.

URL: <http://www.icom.co.jp/world/index.html>

* Purchase separately

■ Packet (AFSK) operation

Before operating packet (AFSK), be sure to consult the operating manual that came with your TNC.

- ① Connect the TNC and PC. (p. 92)
- ② Select the desired band. (p. 25)
- ③ Push [SSB] or [AM/FM] to select the desired operating mode.
- ④ Hold down the same key you pushed in step ③ for 1 second to select the Data mode.
- ⑤ Rotate [DIAL] to select the desired frequency.
- ⑥ Transmit your AFSK signals using your PC's keyboard.
 - Rotate the [RF PWR] control to set the output power.
 - While using a TNC, the relative strength of the transmitted signal is indicated on the Po meter.
 - When operating in the SSB data mode, adjust the output power so that the ALC meter reading stays in the ALC zone.

NOTE: When connecting the TNC to the ACC socket on the rear panel, select the USB, LSB, AM and FM data mode, or disconnect the microphone and rotate the [MIC] control fully counterclockwise. When the "DATA MOD" item is set to "ACC" (default) in the Set mode, and the data mode is selected, the audio input from the [MIC] connector is automatically cut. In that case, the audio input from the [ACC] socket is used. Also, when the data mode is selected, the fixed settings listed below are automatically selected;

- Speech compressor : OFF
- Transmit bandwidth : MID (Fixed to the default value; 300 Hz to 2700 Hz.)
- Tx tone (Bass) : 0
- Tx tone (Treble) : 0

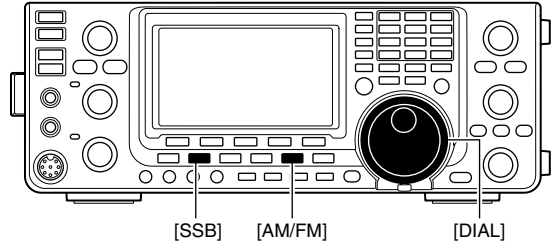

Appears when the data mode is selected.

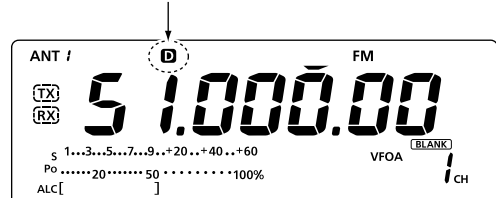

◇ Frequency display during AFSK operation

When operating AFSK in the SSB mode, the displayed frequency is the signal's carrier point.

- **Example**— LSB/LSB data mode
 Mark freq.: 2125 Hz
 Shift freq.: 200 Hz

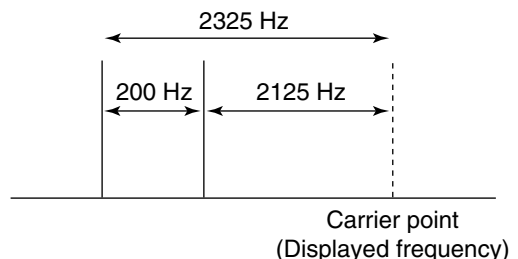

■ Opening the transceiver's case

Icom strongly suggests that the customer have their dealer or Icom distributor, for a reasonable fee, install Icom options at the time of the order. Icom understands that even the simplest of installations demands the judgment of a trained Icom technician. Therefore, Icom will not be responsible for damage to the optional unit, or subsequent damage to the transceiver due to user installation problems. The option's or the transceiver's Warranty can be voided in such situations, at the sole judgment of Icom.

For those customers who still wish to install their own options, knowing the risks and possible consequences, the following information is provided for information purposes only.

The following are instructions for removing the covers of the IC-7410.

⚠ WARNING! Turn OFF the power and disconnect the DC power cable from the transceiver before performing any work on the transceiver. Otherwise, there is danger of electric shock and/or equipment damage.

① Remove the two screws from the carrying handle and remove it from the transceiver.

② Remove the six screws from the top of the transceiver and the six screws from the sides, then lift up the top cover.

③ Turn the transceiver upside-down.

CAUTION: NEVER HOLD THE UNIT BY THE DIAL OR ANY OTHER KNOBS when you turn the transceiver upside down. This may damage them, or cause you to drop the transceiver.

④ Remove the six screws from the bottom, and then lift off the bottom cover.

✓ About the leg pads

To detach the leg pads from the right side panel of the top/bottom cover, push them out from the inside of each cover, after completing steps ① through ④ above.

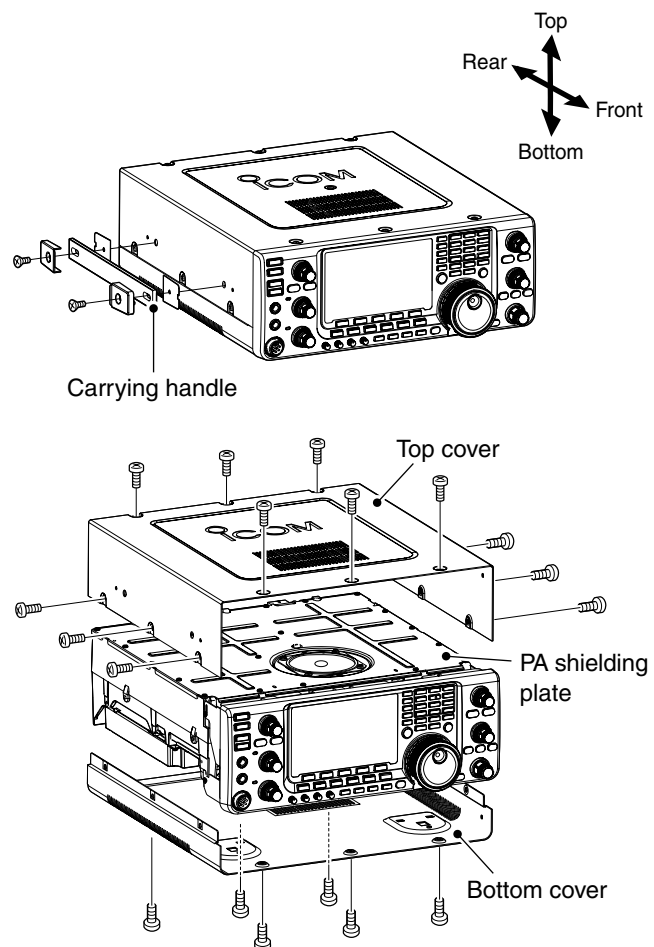

■ FL-430/FL-431 1ST IF FILTER installation

The optional filters, FL-430 1ST IF FILTER (6 kHz) or FL-431 1ST IF FILTER (3 kHz) provides 6 or 3 kHz filtering to reduce interference from strong nearby signals.

- ① Remove the top and bottom covers as shown on page 94.
- ② Install the FL-430 or FL-431 as shown to the right.
 - The connectors on the IC-7410 are marked for the appropriate filter.
 - Ensure the FL-430 or FL-431 is installed correctly.
- ③ Return the top and bottom covers to the original positions.

/// After installation, a 6 kHz or 3 kHz filter width can be used. See page 58 for details.

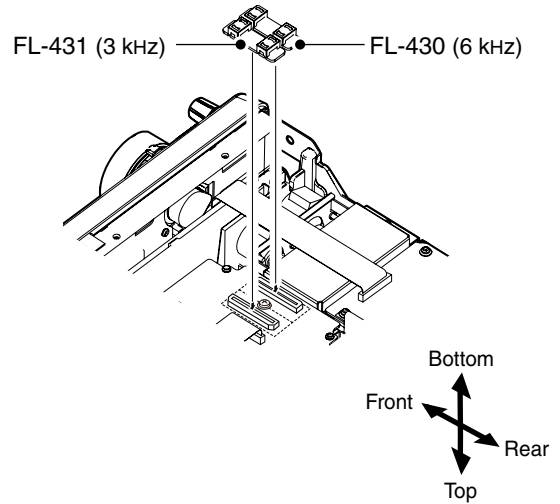

■ Troubleshooting

The following chart is designed to help you correct problems which are not equipment malfunctions.

If you are unable to locate the cause of a problem, or solve it through the use of this chart, contact your nearest Icom Dealer or Service Center.

◇ Transceiver power

PROBLEM	POSSIBLE CAUSE	SOLUTION	REF.
Power does not turn ON when the [POWER] switch is pushed.	<ul style="list-style-type: none"> • The power cable is improperly connected. • A fuse is blown. 	<ul style="list-style-type: none"> • Re-connect the DC power cable correctly. • Correct the cause, then replace the fuse with an equivalent fuse. (Fuses are installed in the DC power cable and in the internal PA unit.) 	p. 19 p. 99

◇ Transmit and receive

PROBLEM	POSSIBLE CAUSE	SOLUTION	REF.
No sound from the speaker.	<ul style="list-style-type: none"> • The audio volume level is too low. • The squelch is closed. • The transceiver is in transmit. 	<ul style="list-style-type: none"> • Rotate the [AF] control clockwise to obtain a suitable listening level. • Rotate the [RF/SQL] control to 11 o'clock position to open the squelch. • Push [TRANSMIT] to receive or check the SEND line of an external unit, if connected. 	p. 31 p. 32 p. 34
Sensitivity is too low, and only strong signals are audible.	<ul style="list-style-type: none"> • The antenna is not connected properly. • The antenna for another band is selected. • The antenna is not properly tuned. • The attenuator is turned ON. 	<ul style="list-style-type: none"> • Re-connect to the antenna connector. • Select an antenna suitable for the operating frequency. • Hold down [TUNER] for 1 second to manually tune the antenna. • Push [P.AMP/ATT] to turn OFF the attenuator. 	— p. 82 p. 83 p. 55
Received audio is unclear or distorted.	<ul style="list-style-type: none"> • The operating mode is not matched. • The Passband Tuning function is turned ON. • The Noise Blanker function is turned ON when receiving a strong signal. • Preamplicifier is turned ON. • The Noise Reduction function is turned ON and the [NR] control is too far clockwise. 	<ul style="list-style-type: none"> • Select a suitable operating mode. • Hold down [PBT-CLR] for 1 second to reset the function. • Push [NB] to turn OFF the function. • Push [P.AMP/ATT] once or twice to turn OFF the function. • Set the [NR] control for maximum readability. 	p. 31 p. 59 p. 60 p. 55 p. 61
[ANT•METER] does not function	<ul style="list-style-type: none"> • The Antenna Switch function is set to "OFF." 	<ul style="list-style-type: none"> • Set the Antenna Switch function to "Auto" or "Manual" in the Set mode. 	p. 87
Transmitting is impossible.	<ul style="list-style-type: none"> • The operating frequency is outside the selected ham band. 	<ul style="list-style-type: none"> • Set the frequency to be within the selected ham band. 	p. 26
Output power is too low.	<ul style="list-style-type: none"> • The [RF PWR] control is set too far counterclockwise. • The [MIC] control is set too far counterclockwise. • The antenna for another band is selected. • The antenna is not properly tuned. 	<ul style="list-style-type: none"> • Rotate the [RF PWR] control clockwise. • Set the [MIC] control to a suitable position. • Select an antenna suitable for the operating frequency. • Hold down [TUNER] for 1 second to manually tune the antenna. 	p. 34 p. 34 p. 82 p. 83
No contact can be made with another station.	<ul style="list-style-type: none"> • The RIT or ΔTX function is turned ON. • The Split function is turned ON. 	<ul style="list-style-type: none"> • Push [RIT] or [ΔTX] to turn OFF the function. • Push [SPLIT] to turn OFF the function. 	pp. 53, 65 p. 66
Transmit signal is unclear or distorted.	<ul style="list-style-type: none"> • The [MIC] control is set too far clockwise. 	<ul style="list-style-type: none"> • Set the [MIC] control to a suitable position. 	p. 34
Repeater cannot be accessed.	<ul style="list-style-type: none"> • The Split function is not turned ON. • The programmed subaudible tone frequency is wrong. 	<ul style="list-style-type: none"> • Push [SPLIT] to turn ON the function. • Reset the frequency using the Set mode. 	p. 66 p. 52

■ Troubleshooting (continued)

◇ Scanning

PROBLEM	POSSIBLE CAUSE	SOLUTION	REF.
A programmed scan does not stop.	• Squelch is open.	• Set the [RF/SQL] control to the threshold point.	p. 32
A programmed scan does not start.	• The same frequencies are programmed into the Scan Edge Memory channels "P1" and "P2."	• Program different frequencies into the Scan Edge Memory channels "P1" and "P2."	p. 70
A memory scan does not start.	• Two or more memory channels have not been programmed.	• Program more than two memory channels.	p. 70
A select memory scan does not start.	• Two or more memory channels have not been designated as select channels.	• Designate more than two memory channels as select channels for the scan.	p. 80
A ΔF scan does not start.	• The center frequency for the ΔF scan is not programmed.	• Program the center frequency for the ΔF scan.	p. 81

◇ Display

PROBLEM	POSSIBLE CAUSE	SOLUTION	REF.
The displayed frequency does not change properly.	<ul style="list-style-type: none"> • The Dial Lock function is turned ON. • The Set mode screen is selected. • The internal CPU has malfunctioned. 	<ul style="list-style-type: none"> • Push [LOCK] to turn OFF the function. • Push [MENU] to exit the Set Mode. • Reset the CPU. 	<p>p. 61</p> <p>p. 85</p> <p>p. 100</p>

■ Dial tuning tension adjustment

The tuning tension of [DIAL] may be adjusted to suit your preference.

The tension adjustment is located on the bottom side of the front panel. See the figure to the right.

Slide the tension adjustment to a comfortable level while turning the dial continuously and evenly in one direction.

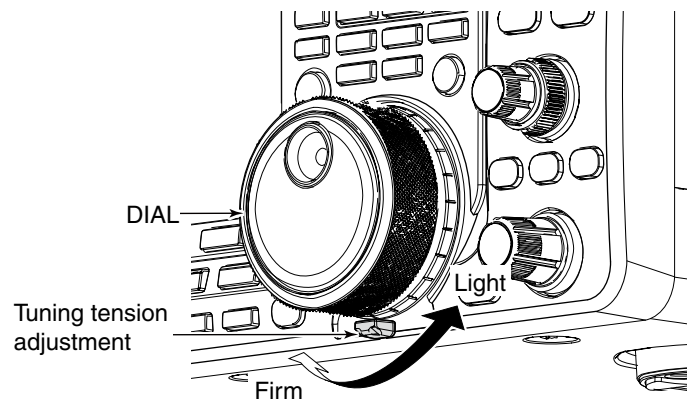

■ Frequency calibration (approximate)

A very accurate frequency counter is required to calibrate the frequency of the transceiver. However, a rough check may be performed by receiving radio station WWV, WWVH, or other standard frequency signals.

CAUTION: The IC-7410 has been thoroughly adjusted and tested at the factory before being shipped. You should not have to re-calibrate it.

- ① Push [SSB] once or twice to select the USB mode.
- ② Push [PBT-CLR] for 1 second to clear the PBT settings and make sure that the RIT/ Δ TX function is turned OFF.
- ③ Set the frequency to the standard frequency station minus 1 kHz.
 - When receiving WWV or WWVH (at 15.000.00 MHz) as a standard frequency, set the operating frequency for 14.999.00 MHz.
 - Other standard frequencies can also be used.
- ④ Hold down [MENU] for 1 second to enter the Set mode.
- ⑤ Push [\blacktriangle](F-1) or [\blacktriangledown](F-2) to select “Calibration Marker.”
- ⑥ Rotate [DIAL] to turn ON the calibration marker.
 - A sidetone may be heard.
- ⑦ Push [\blacktriangledown](F-2) to select “REF Adjust.”
- ⑧ Rotate [DIAL] to adjust for a zero beat with the received standard signal.
 - Zero beat means that two signals are exactly the same frequency, resulting in a single tone being heard.
- ⑨ Push [\blacktriangle](F-1) to select “Calibration Marker.”
- ⑩ Rotate [DIAL] to turn OFF the calibration marker.
- ⑪ Push [MENU] to save, and exit the Set mode.

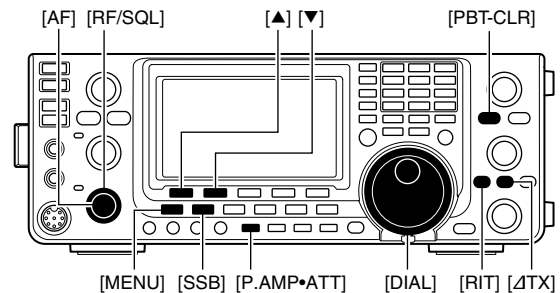

• Calibration marker item



• REF Adjust item



■ About protection displays

The IC-7410 2-step protection function monitors the power amplifier temperature and activates when the temperature becomes extremely high.

• Reduced power transmission

Halves the transmit output power. “LMT” appears above the TX icon “ \square TX.” (p. 11)

• Transmission inhibit

Deactivates the transmitter. Even if you push [PTT] or [TRANSMIT], the TX indicator does not light.

When the protector is activated, operate in only the stand-by or receive mode until the power amplifier cools down.

NOTE: DO NOT turn OFF the transceiver power when the protector is ON, or the cooling fan will not function, and delay cooling the transceiver.

■ Fuse replacement

If a fuse blows, or the transceiver stops functioning, find the source of the problem, and repair it. Then replace the damaged fuse with a new, adequately rated fuse.

⚠ WARNING! Turn OFF the power and disconnect the DC power cable from the transceiver before performing any work on the transceiver. Otherwise, there is danger of electric shock, equipment damage and/or fire injury,

The IC-7410 has two fuse types installed for transceiver protection.

- DC power cable fuses ATC 30 A
- Circuitry fuse ATC 5 A

◇ DC power cable fuse replacement

Refer to the figure illustrated to the right for the DC power cable fuse replacement.

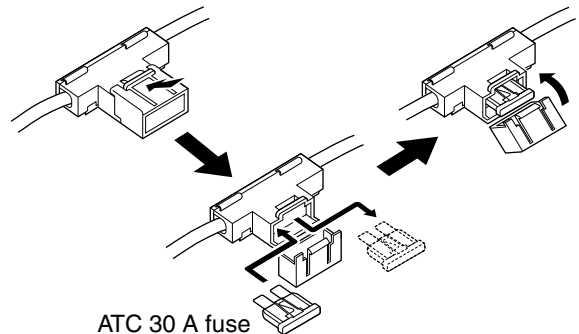

◇ Circuitry fuse replacement

Except for the power amplifier, the 13.8 V DC from the DC power cable is applied to all units in the IC-7410, through the circuitry fuse. This fuse is located in the PA unit.

- ① Remove the top cover. (p. 94)
- ② Remove the 22 screws, then remove the PA shielding plate as shown to the right.
- ③ Remove the speaker cable from the connector on the PA unit as shown to the right.
- ④ Replace the circuitry fuse as shown in the diagram to the right.
- ⑤ Replace the speaker cable, PA shielding plate, top cover and screws to their original position.

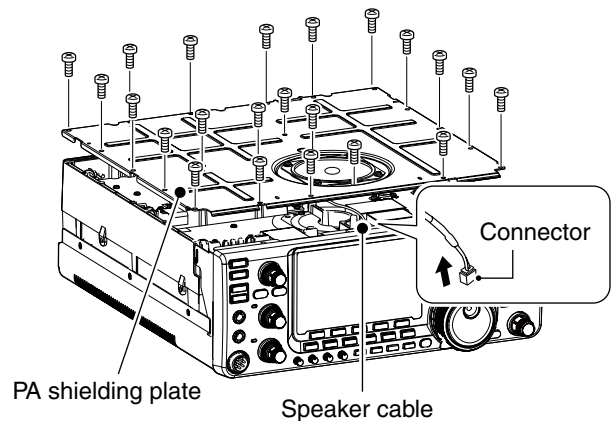

⚠ CAUTION: DO NOT pull the speaker cable when removing the PA shielding plate, or **DO NOT** put the speaker cable under the PA shielding plate when replacing it. This could damage the transceiver.

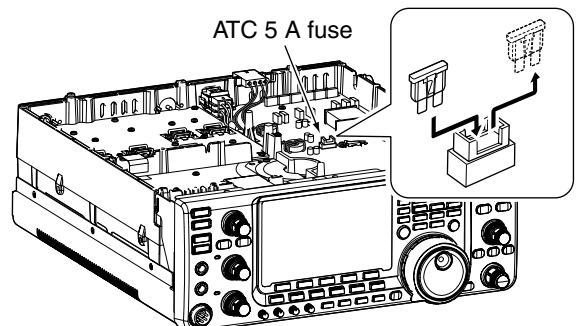

■ Resetting the CPU

◇ Partial reset

If you want to reset the operating parameters to their default values (VFO frequency, VFO settings, menu group's contents) without clearing certain data as described below, a partial reset can be performed.

The following data will not be cleared when doing a Partial reset:

- Memory contents
- Memory keyer contents
- Programmed user band edge frequencies
- REF Adjust (Reference frequency) setting

- ① First, turn OFF the transceiver power.
- ② While holding down [F-INP ENT] and [VFO/MEMO], push [POWER] to turn ON the power.
 - During start-up, the transceiver displays "PARTIAL RESET," then the initial VFO frequencies when resetting is complete.
 - If you operate the transceiver before "PARTIAL RESET" disappears, the resetting will be cancelled.
- ③ If desired, edit the Set mode settings after resetting.

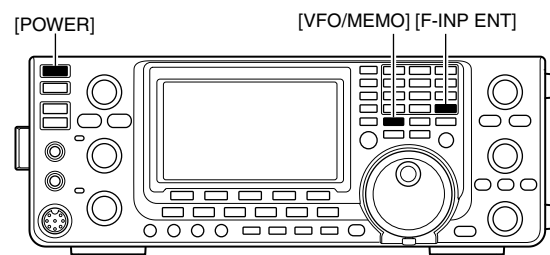

◇ All reset

The display may occasionally display erroneous information (e.g. when first applying power). This may be caused externally by static electricity or by other factors.

If this problem occurs, turn OFF the power. After waiting a few seconds, turn ON the power again. If the problem persists, perform the following procedure.

NOTE: Resetting the CPU **CLEARs** all programmed contents and returns them to their default settings.

- ① First, turn OFF the transceiver power.
- ② While holding down [F-INP ENT] and [M-CLR], push [POWER] to turn ON the power.
 - During start-up, the transceiver displays "ALL CLEAR," then when resetting is complete, then displays the initial VFO frequencies.
 - If you operate the transceiver before "ALL CLEAR" disappears, the resetting will be cancelled.
- ③ If desired, edit the Set mode settings after resetting.

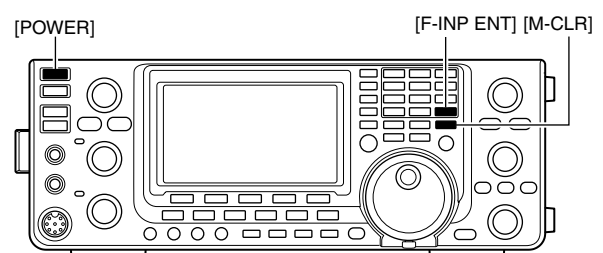

14 CONTROL COMMAND

Remote jack (CI-V) information

CI-V connection example

The transceiver can be connected through an optional CT-17 CI-V LEVEL CONVERTER to a PC equipped with an RS-232C port. The Icom Communications Interface-V (CI-V) controls the transceiver.

Up to 4 Icom CI-V transceivers or receivers can be connected to the PC. See page 89 for setting the CI-V condition using the Set mode.

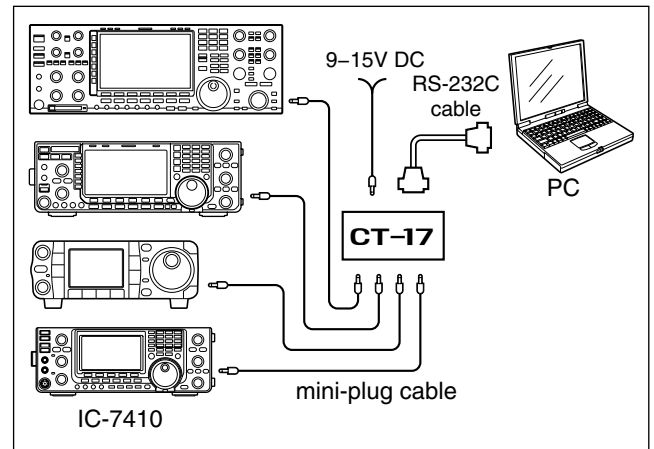

When the transceiver is connected to a PC with a USB cable (purchased separately), the optional CT-17 is not required.

Data format

The CI-V system can be operated using the following data formats. Data formats differ, depending on command numbers. A data area or sub command is added to some commands.

Controller to IC-7410

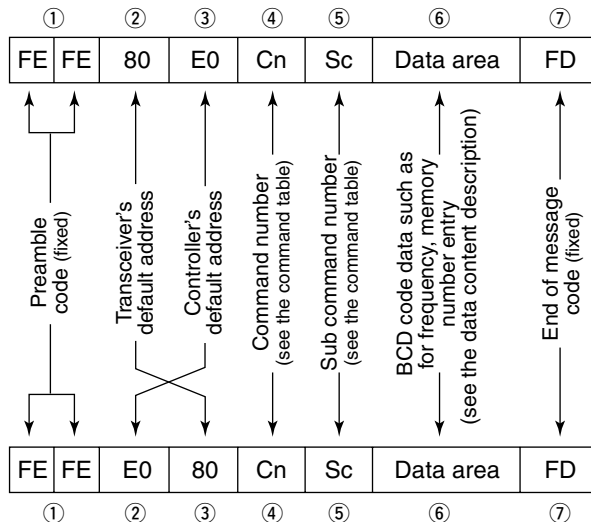

IC-7410 to controller

OK message to controller

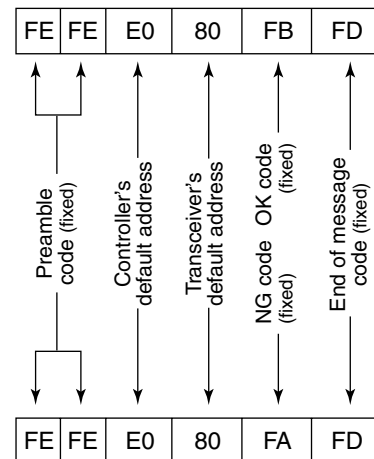

NG message to controller

◇ Command table

Cmd.	Sub cmd.	Data	Description
00		see p. 106	Send operating frequency for transceiver
01		see p. 106	Send operating mode for transceiver
02		see p. 106	Read band edge frequencies
03		see p. 106	Read operating frequency
04		see p. 106	Read operating mode
05		see p. 106	Send operating frequency
06		see p. 106	Send operating mode
07			Select VFO mode
	00		Select VFO A
	01		Select VFO B
	A0		Equalize VFO A and VFO B
	B0		Exchange VFO A and VFO B
08			Select Memory mode
		0001 to 0101	Select memory channel (0001=M-CH01 to 0099=M-CH99, 0100=P1, 0101=P2)
09			Memory write
0A			Memory copy to VFO
0B			Memory clear
0E	00		Scan stop
	01		Programmed/memory scan start
	02		Programmed scan start
	03		Δ F scan start
	12		Fine programmed scan start
	13		Fine Δ F scan start
	22		Memory scan start
	23		Select memory scan start
	A1		Set Δ F scan span ± 5 kHz
	A2		Set Δ F scan span ± 10 kHz
	A3		Set Δ F scan span ± 20 kHz
	A4		Set Δ F scan span ± 50 kHz
	A5		Set Δ F scan span ± 100 kHz
	A6		Set Δ F scan span ± 500 kHz
	A7		Set Δ F scan span ± 1 MHz
	B0		Set as non-select channel
	B1		Set as select channel
	D0		Set scan resume OFF
	D3		Set scan resume ON
0F			Read Split function (00=OFF, 01=ON)
	00		Set the Split function OFF
	01		Set the Split function ON
10		00	Send/read the tuning step 10 Hz (1 Hz)
		01	Send/read the tuning step 100 Hz
		02	Send/read the tuning step 1 kHz
		03	Send/read the tuning step 5 kHz
		04	Send/read the tuning step 9 kHz
		05	Send/read the tuning step 10 kHz
		06	Send/read the tuning step 12.5 kHz
		07	Send/read the tuning step 20 kHz
		08	Send/read the tuning step 25 kHz
11		00	Send/read attenuator OFF
		20	Send/read 20 dB attenuator
12		00	Send/read ANT1 selection
		01	Send/read ANT2 selection
13	00		Announce operating frequency, operating mode and S-meter level with voice synthesizer
	01		Announce operating frequency and S-meter level with voice synthesizer
	02		Announce operating mode with voice synthesizer

Cmd.	Sub cmd.	Data	Description
14	01	0000 to 0255	Send/read [AF] position (0000=max. CCW, 0255=max. CW)
	02	0000 to 0255	Send/read [RF] position (0000=max. CCW, 0255=11 o'clock)
	03	0000 to 0255	Send/read [SQL] position (0000=11 o'clock, 0255=max. CW)
	06	0000 to 0255	Send/read [NR] position (0000=max. CCW, 0255=max. CW)
	07	0000 to 0255	Send/read inner [TWIN PBT] position (0000=max. CCW, 0128=center, 0255=max. CW)
	08	0000 to 0255	Send/read outer [TWIN PBT] position (0000=max. CCW, 0128=center, 0255=max. CW)
	09	0000 to 0255	Send/read [CW PITCH] position (0000=max. CCW (300 Hz), 0128=center (600 Hz), 0255=max. CW (900 Hz))
	0A	0000 to 0255	Send/read [RF PWR] position (0000=max. CCW to 0255=max. CW)
	0B	0000 to 0255	Send/read [MIC] position (0000=max. CCW to 0255=max. CW)
	0C	0000 to 0255	Send/read [KEY SPEED] position (0000=max. CCW to 0255=max. CW)
	0D	0000 to 0255	Send/read [NOTCH] position (0000=max. CCW, 0128=center, 0255=max. CW)
	0E	0000 to 0255	Send/read [COMP] position (0000=max. CCW to 0255=max. CW)
	0F	0000 to 0255	Send/read [BK-IN DELAY] position (0000=max. CCW to 0255=max. CW)
	12	0000 to 0255	Send/read [NB] position (0000=max. CCW to 0255=max. CW)
	15	0000 to 0255	Send/read [MONI GAIN] position (0000=max. CCW to 0255=max. CW)
	16	0000 to 0255	Send/read VOX gain (0000=0% to 0255=100%)
	17	0000 to 0255	Send/read Anti VOX gain (0000=0% to 0255=100%)
	18	0000 to 0255	Send/read CONTRAST level (0000=0% to 0255=100%)
	19	0000 to 0255	Send/read BRIGHT level (0000=0% to 0255=100%)
15	01	00	Read squelch state (squelch close)
		01	Read squelch state (squelch open)
	02	0000 to 0255	Read S-meter level (0000=S0, 0120=S9, 0240=S9+60 dB)
	11	0000 to 0255	Read RF power meter (0000=0%, 0141=50%, 0215=100%)
	12	0000 to 0255	Read SWR meter (0000=SWR1.0, 0041=SWR1.5, 0081=SWR2.0, 0120=SWR3.0)
	13	0000 to 0255	Read ALC meter (0000=Min., 0120=Max.)
	14	0000 to 0255	Read COMP meter (0000=0 dB, 0120=15 dB, 0240=30 dB)
16	02	00	Send/read Preamp OFF
		01	Send/read Preamp 1 ON
		02	Send/read Preamp 2 ON
	12	01	Send/read AGC FAST
		02	Send/read AGC MID
		03	Send/read AGC SLOW
	22	00	Send/read Noise Blanker OFF
		01	Send/read Noise Blanker ON
	40	00	Send/read Noise Reduction OFF
		01	Send/read Noise Reduction ON
	41	00	Send/read Auto Notch function OFF
		01	Send/read Auto Notch function ON

14 CONTROL COMMAND

◇ Command table (continued)

Cmd.	Sub cmd.	Data	Description	
16	42	00	Send/read Repeater tone OFF	
		01	Send/read Repeater tone ON	
	43	00	Send/read Tone squelch OFF	
		01	Send/read Tone squelch ON	
	44	00	Send/read Speech Compressor OFF	
		01	Send/read Speech Compressor ON	
	45	00	Send/read Monitor function OFF	
		01	Send/read Monitor function ON	
	46	00	Send/read VOX function OFF	
		01	Send/read VOX function ON	
	47	00	Send/read BK-IN function OFF	
		01	Send/read Semi BK-IN function ON	
		02	Send/read Full BK-IN function ON	
	48	00	Send/read Manual Notch function OFF	
		01	Send/read Manual Notch function ON	
	4C	00	Send/read VSC function OFF	
		01	Send/read VSC function ON	
	4F	00	Send/read Twin Peak Filter OFF	
		01	Send/read Twin Peak Filter ON	
	50	00	Send/read Dial Lock function OFF	
		01	Send/read Dial Lock function ON	
	55	00	Send/read 1st IF filter 15 kHz	
		01	Send/read 1st IF filter 6 kHz	
		02	Send/read 1st IF filter 3 kHz	
	56	00	Send/read DSP filter type SHARP	
		01	Send/read DSP filter type SOFT	
	57	00	Send/read manual notch width WIDE	
01		Send/read manual notch width MID		
02		Send/read manual notch width NAR		
58	00	Send/read SSB transmit bandwidth WIDE		
	01	Send/read SSB transmit bandwidth MID		
	02	Send/read SSB transmit bandwidth NAR		
17		see p. 107	Send CW messages	
19	00		Read the transceiver ID	
1A	00	see p. 108	Send/read memory contents	
	01	see p. 106	Send/read band stacking register contents	
	02	see p. 107	Send/read memory keyer contents	
	03	00 to 49	Send/read the selected filter width (AM: 00=200 Hz to 49=10 kHz; other than AM modes: 00=50 Hz to 40/31=3600 Hz/2700 Hz)	
			Send/read the selected AGC time constant (00=OFF, AM: 01=0.3 sec. to 13=8.0 sec.; other than AM modes: 01=0.1 sec. to 13=6.0 sec.)	
	05	0001	0000 to 0255	Send/read LCD contrast (0000=0% (low) to 0255=100% (high))
		0002	0000 to 0255	Send/read LCD backlight brightness level (0000=0% (dark) to 0255=100% (bright))
		0003	0000 to 0255	Send/read beep level (0000=0% to 0255=100%)
				00
		0004	00	Send/read beep level limit ON
				01
		0005	00	Send/read confirmation beep ON
	01			Send/read band edge beep OFF
	0006	00	Send/read band edge beep ON (Beep sounds with a default band)	
			01	Send/read band edge beep with user setting ON
02			Send/read band edge beep with user setting/TX limit ON	
0007	0050 to 0200	Send/read beep audio frequency (0050=500 Hz to 0200=2000 Hz)		

Cmd.	Sub cmd.	Data	Description	
1A	05	0008	00	Send/read Auto selection for [RF/SQL]
		01	Send/read SQL selection for [RF/SQL]	
		02	Send/read RF+SQL selection for [RF/SQL]	
	0009	00	Send/read Meter Peak Hold function OFF	
		01	Send/read Meter Peak Hold function ON	
	0010	00	Send/read Time-Out Timer (CI-V) OFF	
		01	Send/read 3 min. Time-Out Timer (CI-V)	
		02	Send/read 5 min. Time-Out Timer (CI-V)	
		03	Send/read 10 min. Time-Out Timer (CI-V)	
		04	Send/read 20 min. Time-Out Timer (CI-V)	
	0011	00	Send/read 30 min. Time-Out Timer (CI-V)	
		01	Send/read Quick Split function OFF	
	0012	00	Send/read Quick Split function ON	
		01	see p. 107	Send/read FM Split offset frequency (HF)
	0013	00	see p. 107	Send/read FM Split offset frequency (50 MHz)
		01		
	0014	00	Send/read Split Lock function OFF	
		01	Send/read Split Lock function ON	
	0015	00	Send/read Tuner Auto Start OFF	
		01	Send/read Tuner Auto Start ON	
	0016	00	Send/read PTT Tune OFF	
		01	Send/read PTT Tune ON	
	0017	00	Send/read antenna selection OFF	
		01	Send/read manual antenna selection	
		02	Send/read auto antenna selection	
	0018	0000 to 0255	Send/read voice synthesizer level (0000=0% to 0255=100%)	
		00	Send/read English selection for voice synthesizer speech language	
	0019	01	Send/read Japanese selection for voice synthesizer speech language	
		00	Send/read speech speed slow	
	0020	01	Send/read speech speed fast	
		00	Send/read S-meter level announcement OFF	
	0021	01	Send/read S-meter level announcement ON	
		00	Send/read operating mode announcement (after pushing mode switch) OFF	
	0022	01	Send/read operating mode announcement (after pushing mode switch) ON	
		00	Send/read number of memo pad channels 5	
	0023	01	Send/read number of memo pad channels 10	
		00	Send/read auto TS for [DIAL] OFF	
	0024	01	Send/read auto TS for [DIAL] Low	
		02	Send/read auto TS for [DIAL] High	
	0025	00	Send/read Low selection for microphone Up/Down speed	
		01	Send/read High selection for microphone Up/Down speed	
	0026	00	Send/read Quick RIT/ΔTX clear OFF	
01		Send/read Quick RIT/ΔTX clear ON		
0027	00	Send/read Auto Notch selection for SSB		
	01	Send/read Manual Notch selection for SSB		
	02	Send/read Auto/Manual Notch selection for SSB		
0028	00	Send/read Auto Notch selection for AM		
	01	Send/read Manual Notch selection for AM		
	02	Send/read Auto/Manual Notch selection for AM		
0029	00	Send/read manual notch filter width pop-up OFF		
	01	Send/read manual notch filter width pop-up ON		

Cmd.	Sub cmd.	Data	Description
1A	05	0030	00 Send/read BW Popup (PBT) setting OFF
		01	Send/read BW Popup (PBT) setting ON
	0031	00	Send/read BW Popup (FIL) setting OFF
		01	Send/read BW Popup (FIL) setting ON
	0032	00	Send/read SSB/CW Synchronous Tuning function OFF
		01	Send/read SSB/CW Synchronous Tuning function ON
	0033	00	Send/read LSB selection for CW normal side
		01	Send/read USB selection for CW normal side
	0034	00	Send/read KEYER-Root selection for keyer 1st menu
		01	Send/read KEYER-SEND selection for keyer 1st menu
	0035	00	Send/read external keypad OFF
		01	Send/read KEYER SEND selection for the external keypad
	0036	00	Send/read USB audio squelch OFF (OPEN)
		01	Send/read USB audio squelch ON
	0037	0000 to 0255	Send/read USB modulation level (0000=0% to 0255=100%)
	0038	00	Send/read MIC selection for the modulation input during DATA mode OFF
		01	Send/read ACC selection for the modulation input during DATA mode OFF
		02	Send/read MIC+ACC selection for the modulation input during DATA mode OFF
		03	Send/read USB selection for the modulation input during DATA mode OFF
	0039	00	Send/read MIC selection for the modulation input during DATA mode operation
		01	Send/read ACC selection for the modulation input during DATA mode operation
		02	Send/read MIC+ACC selection for the modulation input during DATA mode operation
		03	Send/read USB selection for the modulation input during DATA mode operation
	0040	00	Send/read CI-V transceive OFF
		01	Send/read CI-V transceive ON
	0041	00	Send/read CI-V selection for "USB" (COM port) function
		01	Send/read RTTY selection for "USB" (COM port) function
	0042	00	Send/read 300 bps selection for RTTY Decode Baud rate
		01	Send/read 1200 bps selection for RTTY Decode Baud rate
		02	Send/read 4800 bps selection for RTTY Decode Baud rate
		03	Send/read 9600 bps selection for RTTY Decode Baud rate
	0043	00	Send/read Calibration marker OFF
		01	Send/read Calibration marker ON
	0044	0000 to 0255	Send/read reference frequency (0000=0% to 0255=100%)
	0045	see p. 107	Send/read SSB RX HPF/LPF setting
	0046	00 to 10	Send/read SSB RX Tone (Bass) level (00=-5 to 10=+5)
	0047	00 to 10	Send/read SSB RX Tone (Treble) level (00=-5 to 10=+5)

Cmd.	Sub cmd.	Data	Description
1A	05	0048	00 to 10 Send/read SSB TX Tone (Bass) level (00=-5 to 10=+5)
		0049	00 to 10 Send/read SSB TX Tone (Treble) level (00=-5 to 10=+5)
	0050	see p. 107	Send/read SSB TX bandwidth for WIDE
	0051	see p. 107	Send/read SSB TX bandwidth for MID
	0052	see p. 107	Send/read SSB TX bandwidth for NARROW
	0053	see p. 107	Send/read AM RX HPF/LPF setting
	0054	00 to 10	Send/read AM RX tone (Bass) level (00=-5 to 10=+5)
	0055	00 to 10	Send/read AM RX Tone (Treble) level (00=-5 to 10=+5)
	0056	00 to 10	Send/read AM TX tone (Bass) level (00=-5 to 10=+5)
	0057	00 to 10	Send/read AM TX Tone (Treble) level (00=-5 to 10=+5)
	0058	see p. 107	Send/read FM RX HPF/LPF setting
	0059	00 to 10	Send/read FM RX tone (Bass) level (00=-5 to 10=+5)
	0060	00 to 10	Send/read FM RX Tone (Treble) level (00=-5 to 10=+5)
	0061	00 to 10	Send/read FM TX tone (Bass) level (00=-5 to 10=+5)
	0062	00 to 10	Send/read FM TX Tone (Treble) level (00=-5 to 10=+5)
	0063	see p. 107	Send/read CW RX HPF/LPF setting
	0064	see p. 107	Send/read RTTY RX HPF/LPF setting
	0065	00	Send/read Normal selection for contest number style
		01	Send/read "190 → ANO" selection for contest number style
		02	Send/read "190 → ANT" selection for contest number style
		03	Send/read "90 → NO" selection for contest number style
	0066	04	Send/read "90 → NT" selection for contest number style
		01	Send/read M1 selection for count up trigger channel
		02	Send/read M2 selection for count up trigger channel
		03	Send/read M3 selection for count up trigger channel
	0067	04	Send/read M4 selection for count up trigger channel
		0001 to 9999	Send/read present number (0001=1 to 9999=9999)
	0068	0000 to 0255	Send/read CW sidetone gain (0000=0% to 0255=100%)
	0069	00	Send/read CW sidetone gain limit OFF
		01	Send/read CW sidetone gain limit ON
	0070	01 to 60	Send/read CW keyer repeat time (01=1 sec. to 60=60 sec.)
	0071	00	Send/read Normal selection for message display
		01	Send/read Message selection for message display
	0072	28 to 45	Send/read CW keyer dot/dash ratio (28=1:1:2.8 to 45=1:1:4.5)
	0073	00	Send/read 2 msec. selection for Rise time
		01	Send/read 4 msec. selection for Rise time
02		Send/read 6 msec. selection for Rise time	
	03	Send/read 8 msec. selection for Rise time	

14 CONTROL COMMAND

◇ Command table (continued)

Cmd.	Sub cmd.	Data	Description	
1A	05	0074	00	Send/read Normal selection for paddle polarity
		01	Send/read Reverse selection for paddle polarity	
	0075	00	Send/read Straight selection for keyer type	
		01	Send/read BUG-Key selection for keyer type	
		02	Send/read ELEC-Key selection for keyer type	
	0076	00	Send/read Mic. up/down keyer OFF	
		01	Send/read Mic. up/down keyer ON	
	0077	00	Send/read 1275 Hz selection for RTTY mark frequency	
		01	Send/read 1615 Hz selection for RTTY mark frequency	
		02	Send/read 2125 Hz selection for RTTY mark frequency	
	0078	00	Send/read 170 Hz selection for RTTY shift width	
		01	Send/read 200 Hz selection for RTTY shift width	
		02	Send/read 425 Hz selection for RTTY shift width	
	0079	00	Send/read Normal selection for RTTY keying polarity	
		01	Send/read Reverse selection for RTTY keying polarity	
	0080	00	Send/read RTTY decode USOS OFF	
		01	Send/read RTTY decode USOS ON	
	0081	00	Send/read "CR,LF,CR+LF" selection for RTTY decode new line code	
		01	Send/read "CR+LF" selection for RTTY decode new line code	
	0082	00	Send/read 2 lines selection for number of RTTY decoder line	
		01	Send/read 3 lines selection for number of RTTY decoder line	
	0083	00	Send/read Scan speed low	
		01	Send/read Scan speed high	
	0084	00	Send/read Scan resume OFF	
		01	Send/read Scan resume ON	
	0085	00 to 09	Send/read NB depth (00=1 to 09=10)	
	0086	0000 to 0255	Send/read NB width (0000=1 to 0255=100)	
	0087	0000 to 0255	Send/read VOX gain (0000=0% to 0255=100%)	
	0088	0000 to 0255	Send/read ANTI-VOX gain (0000=0% to 0255=100%)	
	0089	00 to 20	Send/read VOX delay time (00=0.0 sec. to 20=2.0 sec.)	
	0090	00	Send/read VOX voice delay OFF	
		01	Send/read Short selection for VOX voice delay	
		02	Send/read Mid selection for VOX voice delay	
		03	Send/read Long selection for VOX voice delay	
	06	see p. 108	Send/read DATA mode selection	

Cmd.	Sub cmd.	Data	Description
1B	00	see p. 108	Send/read Repeater tone frequency
	01	see p. 108	Send/read Tone squelch frequency
1C	00	00	Send/read Transceiver's status (RX)
		01	Send/read Transceiver's status (TX)
	01	00	Send/read Antenna tuner OFF (through)
		01	Send/read Antenna tuner ON
		02	Send/read Manual tuning selection
	02	00	Send/read Transmit frequency monitor check OFF
01		Send/read Transmit frequency monitor check ON	
1E	00		Read number of available TX frequency band
	01	see p. 106	Read TX band edge frequencies
	02		Read number of user-set TX frequency band
	03	see p. 106	Send/read User-set TX band edge frequencies

◇ Data content description

• Character code setting

Command : 1A 00

Character	ASCII code	Character	ASCII code
A–Z	41–5A	a–z	61–7A
0–9	30–39	Space	20
!	21	#	23
\$	24	%	25
&	26	\	5C
?	3F	"	22
'	27	`	60
^	5E	+	2B
-	2D	*	2A
/	2F	.	2E
,	2C	:	3A
;	3B	=	3D
<	3C	>	3E
(28)	29
[5B]	5D
{	7B	}	7D
!	7C	_	5F
-	7E	@	40

• Operating frequency

Command : 00, 03, 05

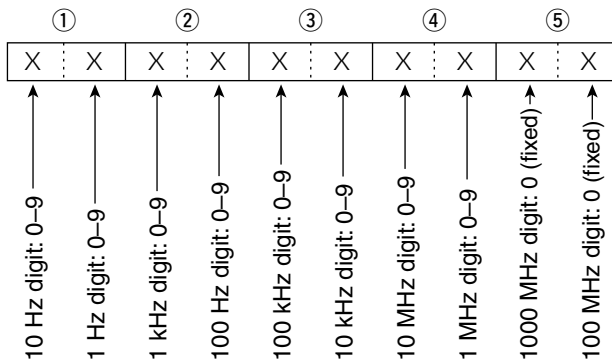

• Operating mode

Command : 01, 04, 06

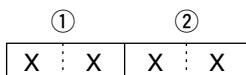

① Operating mode		② Filter setting	
00: LSB	03: CW	07: CW-R	01: FIL1
01: USB	04: RTTY	08: RTTY-R	02: FIL2
02: AM	05: FM		03: FIL3

Filter setting (②) can be skipped with command 01 and 06. In that case, "FIL1" is automatically selected with command 01 and the default filter setting of the operating mode is selected with command 06.

• Band edge frequency setting

Command 02*, 1E 01, 1E 03

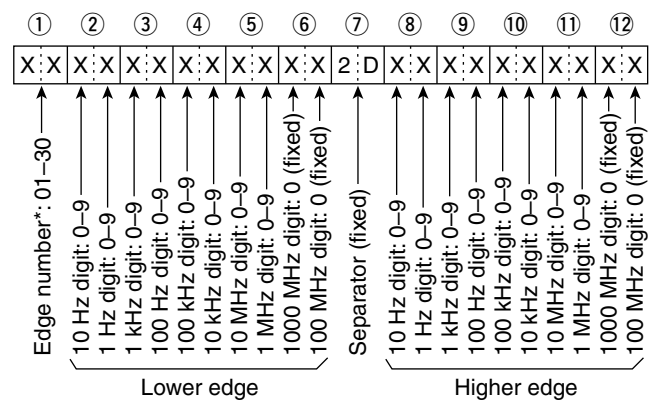

* Edge number setting is not necessary with command 02.

• Band stacking register

Command : 1A 01

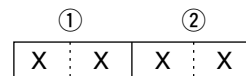

① Frequency band code

Code	Freq. band	Frequency range (unit: MHz)
01	1.8	1.800000–1.999999
02	3.5	3.400000–4.099999
03	7	6.900000–7.499999
04	10	9.900000–10.499999
05	14	13.900000–14.499999
06	18	17.900000–18.499999
07	21	20.900000–21.499999
08	24	24.400000–25.099999
09	28	28.000000–29.999999
10	50	50.000000–54.000000
11	GENE	Other than above

② Register code

Code	Registered No.
01	1 (latest)
02	2
03	3 (oldest)

For example, when reading the oldest contents in the 21 MHz band, the code "0703" is used.

When sending the contents, the codes, such as operating frequency and operating mode*, should be added after the register code, as shown above.

*See "Memory content setting (④ to ⑱)" for details. (p. 108)

14 CONTROL COMMAND

◇ Data content description (continued)

• Memory keyer contents

Command : 1A 02

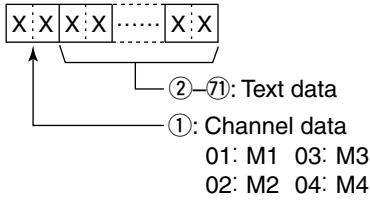

• Character's code

Character	ASCII code	Description
0-9	30-39	Number
A-Z	41-5A	Alphabetical characters
a-z	61-7A	Alphabetical characters
space	20	Word space
/	2F	Symbol
?	3F	Symbol
,	2C	Symbol
.	2E	Symbol
@	40	Symbol
^	5E	e.g., to send BT, enter ^BT
*	2A	Inserts contest number (can be used for 1 channel only)

• CW message contents

Command : 17 Up to 30 characters

While transmitting in the CW mode, or if the Break-in function is ON, the transceiver transmits CW code when the PC sends Command 17.

To send CW messages, the following character codes are used.

• Character's code

Character	ASCII code	Description
0-9	30-39	Number
A-Z	41-5A	Alphabetical characters
a-z	61-7A	Alphabetical characters
space	20	Word space
/	2F	Symbol
?	3F	Symbol
.	2E	Symbol
-	2D	Symbol
,	2C	Symbol
:	3A	Symbol
'	27	Symbol
(28	Symbol
)	29	Symbol
=	3D	Symbol
+	2B	Symbol
"	22	Symbol
@	40	Symbol

• Split offset frequency setting

Command : 1A 05 0012, 0013

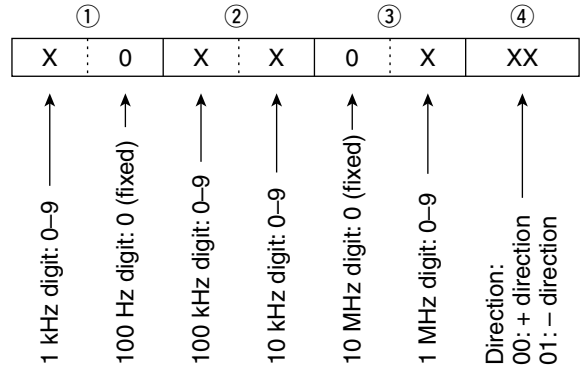

• SSB transmission bandwidth setting

Command : 1A 05 0050, 0051, 0052

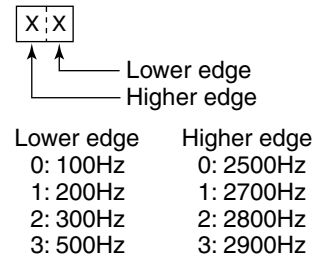

• RX HPF and LPF settings in each operating mode

Command : 1A 05 0045, 0053, 0058, 0063, 0064

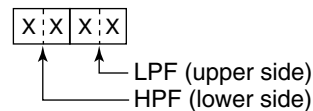

HPF
0: through
1 to 20: 100 to 2000 Hz

LPF
5 to 24: 500 to 2400 Hz
25: through

Set the LPF value larger than HPF one.

- ▨ • "FF" stops sending CW messages.
- ▨ • "A" is used to transmit a string of characters with no inter-character space.

• **Data mode with filter width setting**

Command : 1A 06

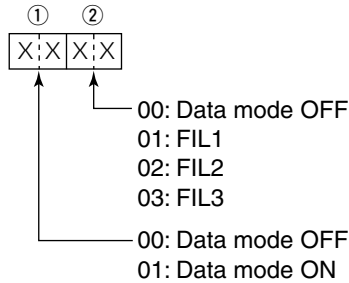

• **Repeater tone/tone squelch frequency setting**

Command : 1B 00, 1B 01

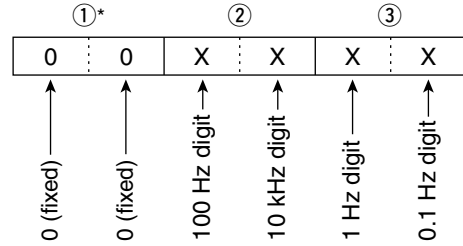

*Not necessary when setting a frequency.

• **Memory content setting**

Command : 1A 00

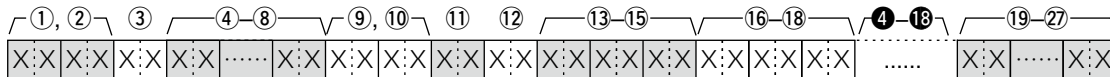

④-⑬: Are programmed in the same manner as ④-⑱.
 When the split setting is ON, these settings are the matching transmit settings.
 Even when the split setting is OFF, these settings are still necessary.
 Be sure the settings are compatible with the specifications of the IC-7410.

①, ② Memory channel number

0001-0099 : Memory channel 01 to 99
 0100 : Programmed scan edge P1
 0101 : Programmed scan edge P2

③ Split and Select memory settings

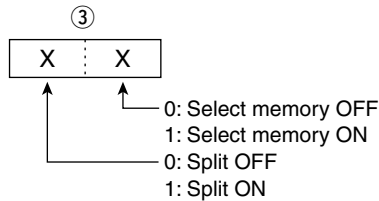

When the program channel is selected, both settings should be "0."

④-⑧ Operating frequency setting
 See "• Operating frequency." (p. 106)

⑨, ⑩ Operating mode setting
 See "• Operating mode." (p. 106)

⑪ Data mode setting

1 byte data (XX)
 00: Data mode OFF
 01: Data mode ON

⑫ Tone setting

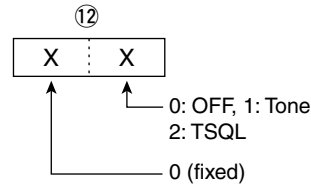

⑬-⑮ Repeater tone frequency setting
 ⑯-⑱ Tone squelch frequency setting
 See "• Repeater tone/tone squelch frequency setting" as described above.

⑲-⑳ Memory name setting
 9 characters (fixed)
 See "• Character code setting." (p. 106)

'1A 00' command with the format as below clears the data of the selected memory channel.

①, ② : Memory channel 0 to 99
 ③ : FF
 ④ or later : None

15 SPECIFICATIONS

■ General

- Frequency coverage : (unit: MHz)
 - Receive
0.030–60.000^{*1*2}
 - Transmit
 - 1.800–1.999^{*2}, 3.500–3.999^{*2},
 - 5.33050^{*3}, 5.34650^{*3}, 5.36650^{*3},
 - 5.37150^{*3}, 5.40350^{*3},
 - 7.000–7.300^{*2}, 10.100–10.150^{*2},
 - 14.000–14.350^{*2}, 18.068–18.168^{*2},
 - 21.000–21.450^{*2}, 24.890–24.990^{*2},
 - 28.000–29.700^{*2}, 50.000–54.000^{*2}
- *1Some frequency bands are not guaranteed.
- *2Depending on version. *3Only USA version.
- Mode : USB, LSB, CW, RTTY, AM, FM
- No. of memory channels : 101CH (99 regular, 2 scan edges)
- Antenna impedance : 50 Ω (at Antenna Tuner OFF)
- Antenna connector type : SO-239 × 2
- Usable temperature range : 0°C to +50°C (+32°F to +122°F)
- Frequency stability : Less than ±0.5 ppm 5 min. after power ON. (0°C to +50°C; +32°F to +122°F)
- Frequency resolution : 1 Hz
- Power supply : 13.8 V DC ±15% (negative ground)
- Power consumption
 - Transmit
 - Max. power : 23.0 A
 - Receive
 - Standby : 2.2 A
 - Max. audio : 3.0 A
- Dimensions : 315(W) × 116(H) × 343(D) mm
(projections not included) 12.4(W) × 4.57(H) × 13.5(D) in
- Weight (approx.) : 10.2 kg; 22.4 lb
- ACC connector : 13-pin
- CI-V connector : 2-conductor 3.5 (d) mm (1/8")

■ Transmitter

- Output power (continuously adjustable)
 - SSB/CW/RTTY/FM : 2 to 100 W
 - AM : 2 to 27 W* (*Carrier power)
(at 13.8 V DC/+25°C)
- Modulation system
 - SSB : Digital PSN modulation
 - AM : Digital Low power modulation
 - FM : Digital Phase modulation
- Spurious emission
 - HF bands : Less than –50 dB
 - 50 MHz band : Less than –63 dB
- Carrier suppression : More than 40 dB
- Unwanted sideband suppression : More than 55 dB
- ΔTX variable range : ±9.999 kHz
- Microphone connector : 8-pin connector (600 Ω)
- ELEC-KEY connector : 3-conductor 6.35(d) mm (1/4")
- KEY connector : 3-conductor 6.35(d) mm (1/4")
- SEND connector : Phono jack (RCA)
- ALC connector : Phono jack (RCA)

Receiver

- Receive system : Double superheterodyne system
- Intermediate frequencies
 - 1st : 64.455 MHz
 - 2nd : 36 kHz
- Sensitivity
 - SSB, CW : 0.16 μV (1.80–29.99 MHz)^{*4}
 - (10 dB S/N) BW=2.4 kHz : 0.13 μV (50.0–54.0 MHz)^{*5}
 - AM (10 dB S/N) : 12.6 μV (0.5–1.799 MHz)^{*4}
 - BW=6 kHz : 2.0 μV (1.80–29.99 MHz)^{*4}
 - : 1.6 μV (50.0–54.0 MHz)^{*5}
 - FM (12 dB SINAD) : 0.5 μV (28.0–29.7 MHz)^{*4}
 - BW=15 kHz : 0.32 μV (50.0–54.0 MHz)^{*5}
- Squelch sensitivity

Frequency band	Squelch sensitivity
HF	SSB : Less than 5.6 μV ^{*4}
	FM : Less than 0.32 μV ^{*4}
50 MHz	SSB : Less than 5.6 μV ^{*5}
	FM : Less than 0.32 μV ^{*5}

^{*4} Preamp 1 is ON. ^{*5} Preamp 2 is ON.

- Selectivity (IF filter shape is set to SHARP.)
 - SSB (BW: 2.4 kHz) : More than 2.4 kHz/–6 dB
Less than 3.4 kHz/–40 dB
 - CW (BW: 500 Hz) : More than 500 Hz/–6 dB
Less than 700 Hz/–40 dB
 - RTTY (BW: 350 Hz) : More than 500 Hz/–6 dB
Less than 800 Hz/–40 dB
 - AM (BW: 6 kHz) : More than 6.0 kHz/–6 dB
Less than 10.0 kHz/–40 dB
 - FM (BW: 15 kHz) : More than 12.0 kHz/–6 dB
Less than 22.0 kHz/–40 dB
- Spurious and image rejection ratio : More than 70 dB
- AF output power : More than 2.0 W at 10%
(at 13.8 V DC) distortion with an 8 Ω load
- RIT variable range : ± 9.999 kHz
- PHONES connector : 3-conductor 6.35 (d) mm ($\frac{1}{4}$ ")
- External SP connector : 2-conductor 3.5 (d) mm
($\frac{1}{8}$ ")/8 Ω
- DSP ANF attenuation : More than 30 dB
(with 1 kHz single tone)
- DSP MNF attenuation : More than 70 dB
- DSP NR attenuation : More than 6 dB
(noise rejection in SSB)

Antenna tuner

- Matching impedance range
 - HF bands : 16.7 to 150 Ω unbalanced
(Less than VSWR 1:3)
 - 50 MHz band : 20 to 125 Ω unbalanced
(Less than VSWR 1:2.5)
- Minimum operating input power : 8 W (HF bands)
15 W (50MHz band)
- Tuning accuracy : VSWR 1:1.5 or less
- Insertion loss (after tuning at RF power 100W)
 - 1.8 MHz band : 1.2 dB or less
 - Bands other than 1.8 MHz : 1.0 dB or less

All stated specifications are typical and subject to change without notice or obligation.

16 OPTIONS

Options

IC-PW1/EURO HF/50 MHz ALL BAND 1 kW LINEAR AMPLIFIER



Full-duty 1 kW linear amplifier including an automatic antenna tuner. Has automatic tuning and band selection capability. Full break-in (QSK) operation is possible. The amplifier/power supply unit and the remote control unit are separated. The optional OPC-599 ADAPTER CABLE is required for connection.

AH-4 HF AUTOMATIC ANTENNA TUNER



Specially designed to tune a long wire antenna for HF/50 MHz bands. The "PTT tune" function provides simple operation.

- Input power rating: 120 W

PS-126 DC POWER SUPPLY



- Output voltage : 13.8 V DC
- Max. output current : 25 A

SP-23 EXTERNAL SPEAKER



4 audio filters; headphone jack; can connect to 2 transceivers.

- Input impedance: 8 Ω
- Max. input power: 4 W

AH-2b ANTENNA ELEMENT



A 2.5 m long antenna element for mobile operation with the AH-4.

- Frequency coverage 7–54 MHz band with the AH-4

SP-21 EXTERNAL SPEAKER



Designed for base station operation.

- Input impedance: 8 Ω
- Max. input power: 5 W

SM-30 DESKTOP MICROPHONE



Unidirectional, electret microphone for base station operation. Includes low cut switch and mic gain control.

SM-50 DESKTOP MICROPHONE



Unidirectional, dynamic microphone for base station operation. Includes [UP]/[DOWN] switches, a low cut switch and mic gain control.

HM-36 HAND MICROPHONE



Hand microphone equipped with [UP]/[DOWN] switches. The same as that supplied with the transceiver.

CT-17 CI-V LEVEL CONVERTER UNIT



For remote transceiver control using a personal computer equipped with an RS-232C port. You can change frequencies, operating mode, memory channels, etc., via your computer.

FL-430 1ST IF FILTER (6 kHz) FL-431 1ST IF FILTER (3 kHz)

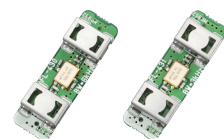



These filters reduce interference from strong nearby signals.

- **OPC-599** ADAPTER CABLE
13-pin, ACC connector to 7-pin + 8-pin ACC connector.

- **MB-123** CARRYING HANDLE
Convenient when carrying the transceiver.
The same as that supplied with the transceiver.

- **OPC-420** SHIELD CONTROL CABLE
For the connection between transceiver and the AH-4.

- **RS-BA1** IP REMOTE CONTROL SOFTWARE
 To remotely control radios using the RS-BA1, **BE SURE**
 that you comply with your local regulations.

Approved Icom optional equipment is designed for optimal performance when used with an Icom transceiver.

Icom is not responsible for the destruction or damage to an Icom transceiver in the event the Icom transceiver is used with equipment that is not manufactured or approved by Icom.

INSTALLATION NOTES

For amateur base station installations it is recommended that the forward clearance in front of the antenna array is calculated relative to the EIRP (Effective Isotropic Radiated Power). The clearance height below the antenna array can be determined in most cases from the RF power at the antenna input terminals.

As different exposure limits have been recommended for different frequencies, a relative table shows a guideline for installation considerations.

Below 30 MHz, the recommended limits are specified in terms of V/m or A/m fields as they are likely to fall within the near-field region. Similarly, the antennas may be physically short in terms of electrical length and that the installation will require some antenna matching device which can create local, high intensity magnetic fields. Analysis of such MF installations is best considered in association with published guidance notes such as the FCC OET Bulletin 65 Edition 97-01 and its annexes relative to amateur transmitter installations.

The EC recommended limits are almost identical to the FCC specified 'uncontrolled' limits and tables exist that show pre-calculated safe distances for different antenna types for different frequency bands. Further information can be found at <http://www.arrl.org/>.

• Typical amateur radio installation

Exposure distance assumes that the predominant radiation pattern is forward and that radiation vertically downwards is at unity gain (sidelobe suppression is equal to main lobe gain). This is true of almost every gain antenna today. Exposed persons are assumed to be beneath the antenna array and have a typical height of 1.8 m.

The figures assume the worst case emission of a constant carrier.

For the bands 10 MHz and higher the following power density limits have been recommended:

10–50 MHz 2 W/sq m

Vertical clearance by EIRP output

1 Watts	2.1 m
10 Watts	2.8 m
25 Watts	3.4 m
100 Watts	5 m
1000 Watts	12 m

Forward clearance by EIRP output

100 Watts	2 m
1000 Watts	6.5 m
10,000 Watts	20 m
100,000 Watts	65 m

In all cases any possible risk depends on the transmitter being activated for long periods. (actual recommendation limits are specified as an average during 6 minutes) Normally the transmitter is not active for long periods of time. Some radio licenses will require that a timer circuit automatically cuts off the transmitter after 1–2 minutes etc.

Similarly some modes of transmission, SSB, CW, AM etc. have a lower 'average' output power and the assessed risk is even lower.

 Versions of the IC-7410 which display the "CE" symbol on the serial number label, comply with the essential requirements of the European Radio and Telecommunication Terminal Directive 1999/5/EC.

 This warning symbol indicates that this equipment operates in non-harmonised frequency bands and/or may be subject to licensing conditions in the country of use. Be sure to check that you have the correct version of this radio or the correct programming of this radio, to comply with national licensing requirement.

• List of Country codes (ISO 3166-1)

	Country	Codes		Country	Codes
1	Austria	AT	18	Liechtenstein	LI
2	Belgium	BE	19	Lithuania	LT
3	Bulgaria	BG	20	Luxembourg	LU
4	Croatia	HR	21	Malta	MT
5	Czech Republic	CZ	22	Netherlands	NL
6	Cyprus	CY	23	Norway	NO
7	Denmark	DK	24	Poland	PL
8	Estonia	EE	25	Portugal	PT
9	Finland	FI	26	Romania	RO
10	France	FR	27	Slovakia	SK
11	Germany	DE	28	Slovenia	SI
12	Greece	GR	29	Spain	ES
13	Hungary	HU	30	Sweden	SE
14	Iceland	IS	31	Switzerland	CH
15	Ireland	IE	32	Turkey	TR
16	Italy	IT	33	United Kingdom	GB
17	Latvia	LV			



DECLARATION OF CONFORMITY

We Icom Inc. Japan
1-1-32, Kamiminami, Hirano-ku
Osaka 547-0003, Japan



Declare on our sole responsibility that this equipment complies with the essential requirements of the Radio and Telecommunications Terminal Equipment Directive, 1999/5/EC, and that any applicable Essential Test Suite measurements have been performed.

Bad Soden 14th Jan. 2011
Place and date of issue

Kind of equipment: HF/50 MHz TRANSCEIVER

Icom (Europe) GmbH
Communication Equipment
Auf der Krautweide 24,
65812 Bad Soden am Taunus,
Germany

Type-designation: IC-7410

Authorized representative name

Version (where applicable):

This compliance is based on conformity with the following harmonised standards, specifications or documents:

Y. Furukawa
General Manager

i) EN 301 489-1 v1.6.1 (September 2005)

ii) EN 301 489-15 v1.2.1 (August 2002)

iii) EN 301 783-2 v1.1.1 (September 2000)

iv) EN 60950-1 2006 A11:2009

v) _____

vi) _____

Signature

Icom Inc.

IC-7410 #03
(Europe)

< Intended Country of Use >
AT BE CY CZ DK EE
FI FR DE GR HU IE
IT LV LT LU MT NL
PL PT SK SI ES SE
GB IS LI NO CH BG
RO TR HR

IC-7410 #04
(Europe-1)

< Intended Country of Use >
AT BE CY CZ DK EE
FI FR DE GR HU IE
IT LV LT LU MT NL
PL PT SK SI ES SE
GB IS LI NO CH BG
RO TR HR

IC-7410 #05
(Italy)

< Intended Country of Use >
AT BE CY CZ DK EE
FI FR DE GR HU IE
IT LV LT LU MT NL
PL PT SK SI ES SE
GB IS LI NO CH BG
RO TR HR

IC-7410 #06
(Spain)

< Intended Country of Use >
AT BE CY CZ DK EE
FI FR DE GR HU IE
IT LV LT LU MT NL
PL PT SK SI ES SE
GB IS LI NO CH BG
RO TR HR

IC-7410 #11
(France)

< Intended Country of Use >
AT BE CY CZ DK EE
FI FR DE GR HU IE
IT LV LT LU MT NL
PL PT SK SI ES SE
GB IS LI NO CH BG
RO TR HR