

Apache Labs LLC



ANAN-10 Users Guide

**This document contains the words Apache, ANAN-10, ANAN-10E,
ANAN-100, ANAN-100D and ANAN-200D
in reference to the Apache Labs Transceiver products
<http://www.apache-labs.com>**

In cooperation with VK6PH, NRØV, W5WC, K5SO
and the OpenHPSDR Hardware and Software Projects
<http://openhpsdr.org>

all images and manufacturer data is copied here with permission of the owner



Apache Labs Copyright statement goes on this page

Contents - ANAN-10 Users Guide

Errata: List of changes to the document:.....	6
Apache Labs LLC, Inc. - Declarations of Conformity.....	7
Apache Labs Products CE and RTTE Certified.....	7
Important Operation tips.....	8
Heat Dissipation.....	8
Clarification CCS (3W]/ICAS (10W] operation.....	8
Chapter 1 - Introduction.....	9
Introduction.....	9
Minimum Requirements.....	9
Suitable routers or LAN Network switches.....	9
Ethernet Connection.....	10
Simple network setup.....	10
ANAN Hardware Requirements.....	11
ANAN Recommended Software requirements:.....	11
ANAN Front Panel.....	12
ANAN back panel.....	13
Chapter 2 - Quick Start Instructions.....	14
Hardware Setup.....	14
Software Setup.....	15
Windows Installation.....	15
Antenna Connections.....	21
Chapter 3 – How to operate SSB Phone.....	22
Connecting a suitable Microphone.....	22
MIC Adapters.....	22
Selecting Transmit Profile.....	24
Adjusting mic gain.....	24
Transmitting.....	26
Tune.....	26
VOX.....	26
Transmit Filter.....	26
HPF/LPF Filters and switching in ANAN Transceiver.....	27
Antenna Control menu allows you to control the following options:.....	28
Chapter 4 – How to operate Digital modes.....	29
Clarification CCS (3W]/ICAS (10W] operation.....	29
Dxzone Software Catalog W1HKJ Fldigi VSP, Com0Com, RigCAT, Omni-Rig, VAC, VB-Audio	29
Chapter 5 – How to operate CW.....	30
Sample Rate.....	30
Iambic A/B.....	30
Paddle Connection.....	31
CWU/CWL.....	31

Select Operating Frequency.....	32
Set Drive Level.....	32
Break-in Delay.....	33
QSK.....	33
Sidetone Level.....	34
Antenna.....	34
Note the Antenna Control menu allows you to control the following options:.....	35
Tuning.....	35
Tune/SWR/Output.....	37
Drive Level.....	38

Chapter 6 – How to Interface to your Linear Amplifier.....39

PTT Input.....	39
PTT Output.....	39
FET.....	39
How to test your PTT Linear Amplifier circuit BEFORE connecting your Apache Transceiver.	39
Various Linear Amplifier Keying ISOLATION are available.....	39
ALC.....	39
Various directional coupler models are available.....	40
VK6PH example OpenCollector BCD keying.....	40

Chapter 7 – How to use PureSignal Adaptive predistortion.....41

Warren Pratt NRØV PureSignal Information.....	41
How to Use PureSignal Adaptive Predistortion.....	41
.....Various directional coupler models are available	43

Chapter 8 – How to install a new version of PowerSDR software.....44

Please refer to the Quick Start Software Installation information in Chapter 2.....	44
Instructions to load independent versions on a single PC are summarized here:.....	44

Chapter 9 - How/when to install a new version of Apache Firmware. 45

HPSDRProgrammer and HPSDRBootloader.....	45
--	----

Pointers to reference materials..... 46

Apache Labs International Support.....	46
Apache Yahoo Support Group.....	46
OpenHPSDR Group.....	46
Apache Service and Repair.....	46
Apache Schematics.....	46
Warren Pratt NRØV PureSignal Information.....	47
Original 2013 Users Guide.....	47
Balanced Audio Input is not implemented in the current Apache Labs Transceivers.....	47
Multiple independent .xml databases.....	47



Manual Calibration Procedure.....	48
Computer Performance.....	49
Warranty.....	50
IMPORTANT.....	50
OpenHPSDR Software.....	51
Contributing members to the Hermes project.....	52
The CORDIC Algorithm.....	53
Accessory Port (back panel).....	54
MARS operation.....	56
APIPA Automatic Private IP Addressing.....	56
Apache Labs ANAN-10/100 (Hermes] PCB.....	58
ANAN-10 jumper locations.....	59
Apache Labs ANAN-10/100 Block Diagram (courtesy VK6PH].....	60

Errata: List of changes to the document:

|



Note: Customer is responsible for FEDEX shipping and all local Customs, Tariff, VAT, Taxes and incidental charges within their delivery (address] Country. Please contact Apache Support <support@apach-labs.com> for details regarding your order or shipping charges.

Apache Labs LLC, Inc. - Declarations of Conformity

The ANAN-10 complies with FCC Part 97 rules for the Amateur Radio Service. It has been confirmed by the relevant authorities that the ANAN-10 DOES NOT require FCC certification of any sort. Under rule 97 Amateur radio equipment with the exception of amplifiers and scanning receivers are exempt from certification, however, must conform to rule 97 which states that harmonic and spurious emissions must be below 43dB of the transmitted out up to 30MHz and 60dB beyond that.

Apache Labs Products CE and RTTE Certified

CE & EC Radio and telecommunications terminal equipment (RTTE] Certification.

We are pleased to announce that the ANAN series HF & 6M SDR transceivers including the ANAN-10 is now CE and RTTE certified as per EU trade directives, All ANAN radios are RoHS compliant as well, we ensure that our products are of the highest quality and meet international standards of quality and compliance.

Important Operation tips



- 1. IMPORTANT: install the supplied 4 rubber feet on bottom of case for proper cooling**
2. Do **not short** the rear speaker jack
3. Do not cover rear or bottom ventilation holes. Proper air circulation throughout the ANAN is necessary to prevent possible overheating and failure.
4. Calibrate power output to 10W using a 50 ohm Dummy Load. Operating SSB/CW at higher levels will damage the radio.
5. Data/AM/FM and other continuous duty modes must be operated at 3W or less to remain within the operational limits of the ANAN
6. Input voltage must be 13.8 +/- 5%, well regulated at 7A and proper **POLARITY** must be observed.
7. DISCONNECT the Antenna during Thunderstorms or when not in use.
8. Please ensure that you select the correct model during software setup.



Heat Dissipation

Apache has stated that "The ANAN-10 uses the heavy duty Aluminum extruded housing to dissipate heat just like most military equipment.

The design specifications for the ANAN-10 has been upgraded since the introduction of the ANAN-10. The "Hermes" Transceiver board has a small Switching Mode Power supply on-board the PCB. The SMPS provides a convenient and efficient way to drop from the 13.8vdc supply voltage to the 3.3vdc needed by several of the Integrated Circuit chips.

Ventilation holes in the bottom and back panel of the ANAN-10 must be clear of obstructions so that the internal fan can circulate cooling air through the unit.

The ANAN-10 should not be operated at greater than 50% of it's rated power when used for extended duty cycles such as digital operation.



Clarification CCS (3W)/ICAS (10W) operation

AM/FM, **CCS** (Continuous Commercial Service] **3W**

SSB, CW and all **ICAS** modes (Intermittent Commercial/Amateur Service] **10W PEP**

The Power Amplifier MOSFET transistors have characteristics that far exceed the needs of normal Transceiver operation. They are quite rugged. However, other internal components such as the Filters, Integrated Circuits, and some small SMT parts must also be considered when modes with high duty cycles are in use. There are three voltage rails all of which have thermal shutdown protection built in.



Chapter 1 - Introduction

Introduction

The ANAN-10 Amateur Radio Transceiver is a modern direct-down-conversion (**DDC**] receiver, and direct-up-conversion (**DDC**] transmitter, Software Defined HF transceiver plus 6 Meters. The ANAN-10 has a proud heritage from the TAPR Hermes Transceiver introduced in 2012. The ANAN-10 was cooperatively designed by the OpenHPSDR Team and Apache Labs. Please see "Contributing Members".

The Apache Labs ANAN equipment includes the "Hermes", "Angelia", and "Orion" designs in a series of new transceivers. The ANAN-10 is operated on a 100Mbps Ethernet interface to the host PC. The ANAN does not use a Firewire™, or USB interface.

Future ANAN firmware updates can be easily installed via the Transceiver standard Ethernet connection, eliminating the need for special mechanical or programming adapters.

ANAN Transceivers can be used with a number of different PC Software Defined Radio programs including those written for Windows®, Linux and MacOS/X®, Android, and other operating systems.

Note: Please see the Apache Labs ANAN Transceivers webpage:

<https://apache-labs.com/index.php>

OpenHPSDR software webpage: <http://openhpsdr.org/download.php>

Minimum Requirements

Computer basic requirements

- Intel i3, 2.8Ghz or better (recommended).
- 4GB Ram or more (recommended).
- 1280x1024 display screen [or higher] resolution recommended
- Windows XP or newer. It is possible that some older machines will not give satisfactory performance, regardless of processor speed.
- Computer with Full Duplex Ethernet NIC card capable of 1000 baseT/Gigabit Ethernet.
- **Full Duplex Ethernet switch** or router with 1 free 1000Mbps Ethernet port.
- CAT5 or CAT6 (recommended) Ethernet patch cable to connect ANAN to Ethernet switch, router, or computer.

Older and slower Desktop, Laptop, Tablets, or Notebook computers may require considerable optimization before they can provide necessary performance for trouble free SDR operation. This optimization may require that certain applications and services be stopped in order for the Apache Software to operate correctly. It is possible some older or slower machines will not give satisfactory performance, regardless of processor speed.

Suitable routers or LAN Network switches

A Full Duplex wired or wireless Ethernet Router with sufficient ports to connect the host computer and the ANAN at 1000 baseT required to handle at least 80Mbps. An optional Full Duplex Ethernet switch with 1000 baseT Internet connectivity may be required if additional Ethernet ports are needed. Ethernet **HUBS will NOT work properly for this software application.**

Ethernet Connection

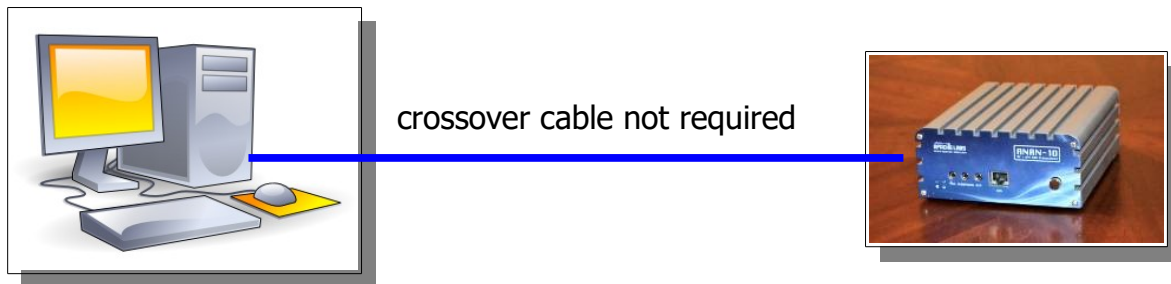

ANAN must be connected directly to a dedicated Ethernet port on the host PC or to a suitable Ethernet router or switch. Connection to a dedicated Ethernet port is shown above

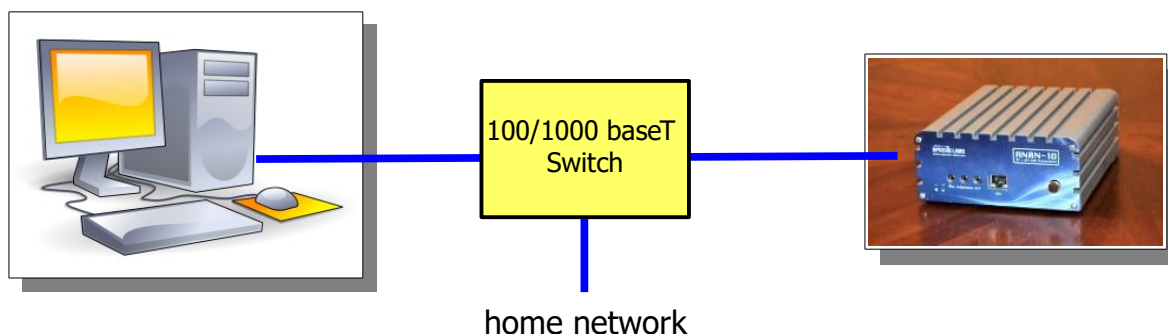

For direct connection of ANAN to a dedicated Ethernet port, a CAT 5 Ethernet cable is used. Note that a 'crossover' cable is **not** necessary.



Note: The Ethernet switch must be capable of operating in **full duplex** mode at 1000 baseT(Gigabit]. The initial release of ANAN FPGA code operates at 100 baseT, but future releases will run at 1000 base-T (Gigabit] speeds. For this reason, a 100 baseT Ethernet switch may be used in the interim, but if a new purchase is planned then a **1000 baseT (Gigabit] switch is recommended.**

An Ethernet "**HUB**" will not work properly and is **not** recommended.

Simple network setup

The OpenHPSDR ANAN Transceivers are designed to work via Ethernet cabling on (a] "Local Area Network" or (b] directly connected to your Windows PC. Ethernet simplifies the installation, and configuration of hardware and software, making the installation basically "plug and play". No sound card interface wiring, no Firewire® cards or drivers, no USB ports or drivers are needed. It just works!

:

- For the most basic network, you don't need any external hardware other than an Ethernet cable between your Windows PC LAN port and your Transceiver's LAN port.
- The ANAN Transceivers are setup to ask for a "DHCP" network address or an APIPA address (discussed in Appendix below]

ANAN Hardware Requirements

- **13.8vdc minimum, 7A (Recommended)**

Note: some switching DC supplies create objectionable EMI/RFI which may degrade performance of the ANAN transceiver.

- Ham band resonant 50 ohm **HF antenna, Dummy Load** required for calibration.
- PC condenser microphone terminated in 3.5mm - 1/8" plug, for SSB "phone" operation.
- CW key terminated in 3.5mm - 1/8" Stereo plug, for CW operation.
- A set of stereo speakers or stereo headphones with a 3.5mm - 1/8" stereo plug.



Note: If a mono plug or a shorted stereo plug is wired into the **rear panel** AUX/IO connector, damage will occur to the audio output IC. Do NOT short these stereo pins or connect either side to ground!

ANAN Recommended Software requirements:

- Windows XP or later – Win7 (or newer] recommended.
- Microsoft .NET 4.0 Framework or later required.
- OpenHPSDR PowerSDR

Windows XP or Windows 7	PowerSDR™, KISS Konsole, ghpsdr3
Linux	cudaSDR, cuSDR, ghpsdr3
MacOS X	Heterodyn
Android	"OpenHPSDR" by John Melton GØORX/N6LYT
Java (for many platforms)	"openhpsdrJ" by John Melton GØORX/N6LYT
- OpenHPSDR Software and download information <http://openhpsdr.org/download.php>.

ANAN Front Panel

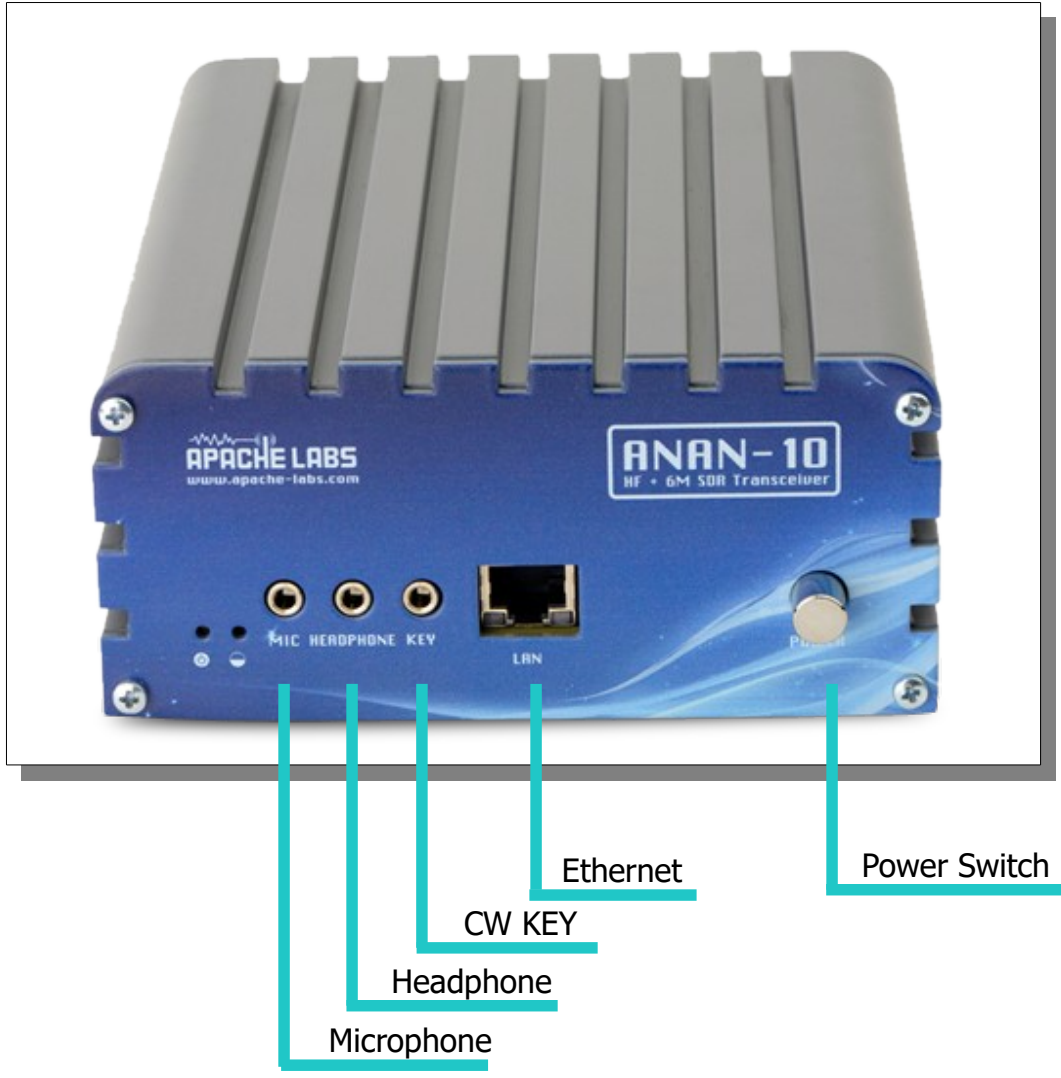

ANAN back panel

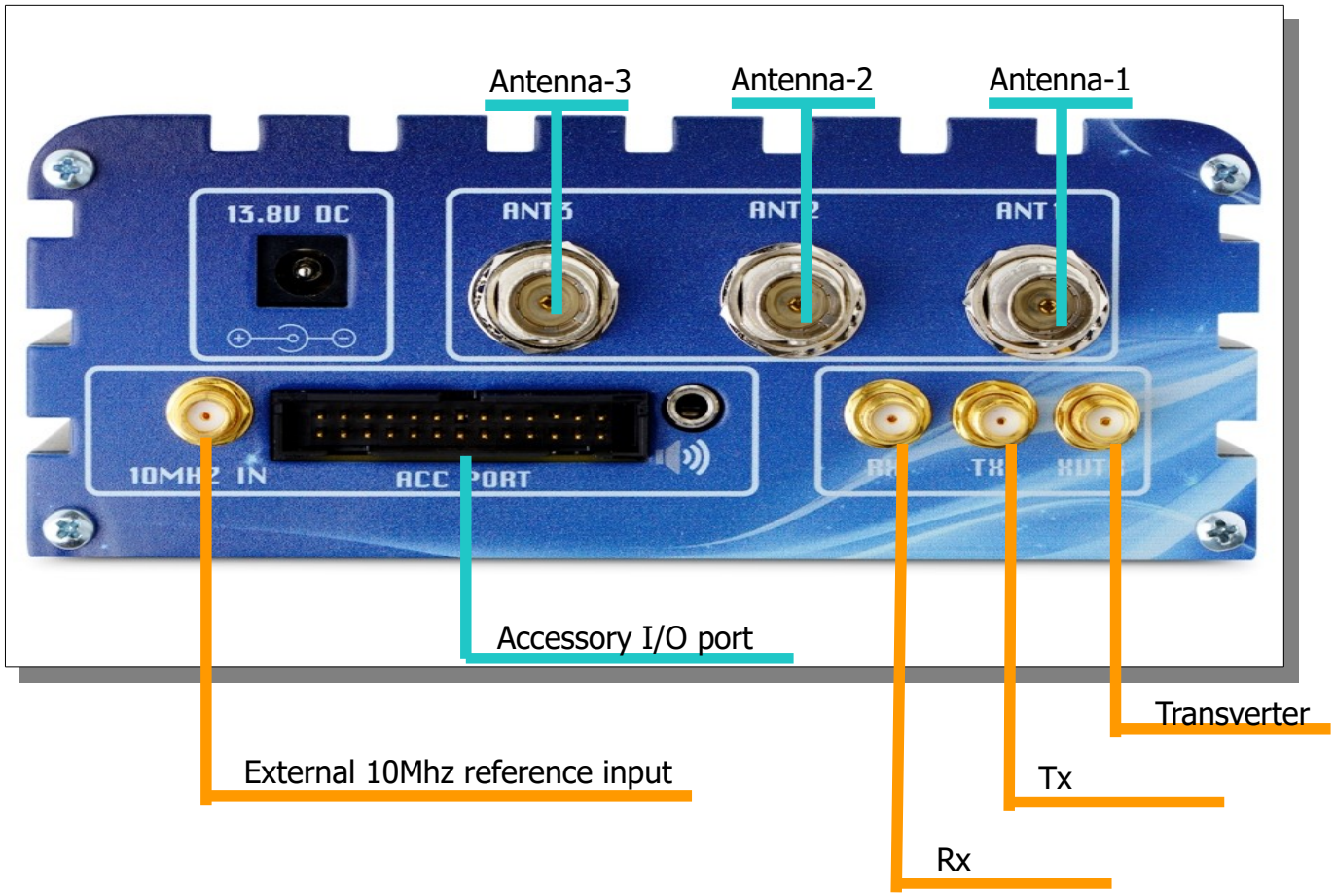

Chapter 2 - Quick Start Instructions

please refer to front and back panel illustrations



Note: these "Quick Start" instructions only apply to the ANAN Transceiver Apache Transceiver board with the jumpers set to the factory defaults.

Please refer to the OpenHPSDR webpage for the most recent documentation by Phil Harman VK6PH for details of the TAPR Hermes Transceiver:

http://svn.tapr.org/repos_sdr_hpsdr/trunk/Hermes/Documentation

also put this in your bookmarks as an excellent resource site:

http://openhpsdr.org/wiki/index.php?title=HPSDRwiki:Community_Portal

Hardware Setup



Note: If a mono plug or a shorted stereo plug is inserted into the rear I/O Accessory Speaker jack, damage will occur to the audio output IC. Do NOT short these stereo pins or connect either side to ground!

- Install the 4 supplied rubber feet.
- The ANAN transceiver should be placed to allow unobstructed airflow around and beneath the housing. Damage can occur if the ventilation openings on the bottom or rear panel of the ANAN Transceiver are blocked. Allow room for airflow between the housing and other equipment.
- Connect the supplied 13.8VDC cable to the rear panel power connector and to a filtered 13.8VDC +/- 5%, power supply capable of providing up to 7A.
- Connect a suitable ground cable to the rear panel ground terminal and to a suitable RF ground, in accordance with good amateur practices.
- Connect a 50 ohm transmission line between the rear panel ANT1 BNC connection and a 50 ohm dummy load.
- Connect powered stereo speakers, or a stereo headset to the front panel 1/8"/3.5mm stereo jack. Note: Do **NOT** connect powered stereo speakers or headsets to the rear panel speaker jack! This is a balanced output and damage can result if either tip or ring is connected to ground.
- For **Phone** operation connect a condenser PC **microphone** equipped with a 1/8"/3.5mm mono plug into the front panel mic jack.
- For **CW** operation, connect your favorite paddles to the **KEY** jack on the front panel.
- Connect a CAT 5 Ethernet cable between the front panel RJ45 LAN jack and your router or PC Ethernet port.



Software Setup

Go to the OpenHPSDR download page and download the OpenHPSDR/PowerSDR_mRX Installer software:
<http://openhpsdr.org/download.php>

scroll down to the WINDOWS section and look for the **latest W5WC software**

Windows

PowerSDR_mRX_v3.0.2.0_Setup (Compiled with MS VS 2010), **More ...**
 Code at SVN: http://svn.tapr.org/repos_sdr_hpsdr/trunk/W5WC/PowerSDR_HPSDR_2

PowerSDR_RX2_v2.2.14.0_(W5WC)_Setup (Compiled with MS VS 2010), **More ...**
 Code at SVN: http://svn.tapr.org/repos_sdr_hpsdr/trunk/W5WC/PowerSDR_HPSDR_2_RX2
 Note: Code has recently been updated to comply with the LGPL license

PowerSDR 2.2.3 Diversity
 This code is maintained off the openHPSDR.org web site by Joe, K5SO, it is based on the PowerSDR 2.2.3 code above.
 Code at SVN: 2.2.3 Diversity code. See website for ZIP files.

KISSKonsoleSetup (Compiled with MS VS 2010), **More ...**
 Code at SVN: http://svn.tapr.org/repos_hpsdr_kiss/trunk/StableRelease/KK_Unified/Latest/Unified/bin/Release

HermesVNASetup Version 1.6.0 16-11-2012 (Compiled with MS VS 2010), **More ...**

cuSDR32_MSVS (Compiled with VS 2010), **More ...**
 Code at SVN: http://svn.tapr.org/repos_sdr_hpsdr/trunk/DL3HVVH/cuSDR32/

cuSDR64_MSVS (Compiled with VS 2010), **More ...**
 Code at SVN: http://svn.tapr.org/repos_sdr_hpsdr/trunk/DL3HVVH/cuSDR64/

example of OpenHPSDR Download webpage

Windows Installation

For example: On the OpenHPSDR Download webpage <http://openhpsdr.org/download.php> you will see:
 OpenHPSDR/PowerSDR (compiled with MS VS 2010). Appendix explains how to install multiple independent versions of PowerSDR.

Execute (**RUN**) to start the Installer at this time.

Note: You may be asked to install the full Microsoft .NET 4.x Framework at this time if the Installer determines that your PC does not have the necessary .NET full 4.0 version installed. If you receive this message, chose "O.K." then you will get a dialogue that will indicate that OpenHPSDR/PowerSDR installation failed at this point. If you have reached this point, you must install the Microsoft .NET 4.0 Framework from [HERE](http://www.microsoft.com/en-us/download/details.aspx?id=17851)

<http://www.microsoft.com/en-us/download/details.aspx?id=17851>



Once you have Microsoft .NET 4.0 installed successfully, you can run the OpenHPSDR/PowerSDR installer again to complete this process. See the example above:

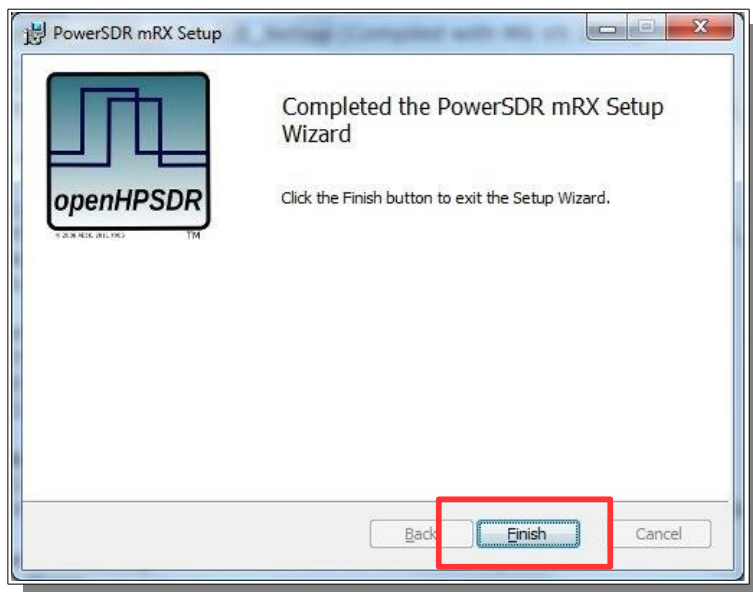
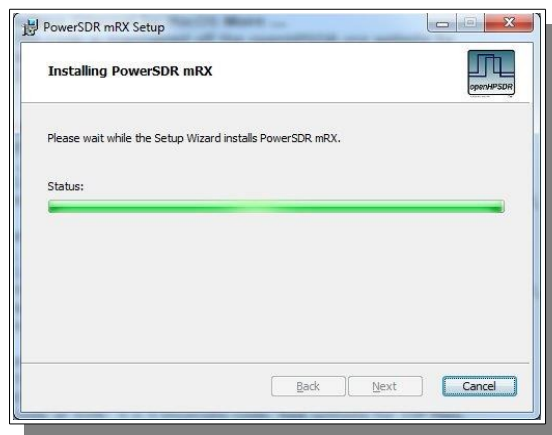

Click on the desktop ICON to start OpenHPSDR/PowerSDR-mRX.

If a OpenHPSDR/PowerSDR_mRX icon is not clearly apparent on your screen, use your start menu to locate the program.

The program will begin with the "WISDOM" optimization. **A one time DOS FFT optimization** screen will appear. **Wait** for this process to finish and the DOS screen will disappear.

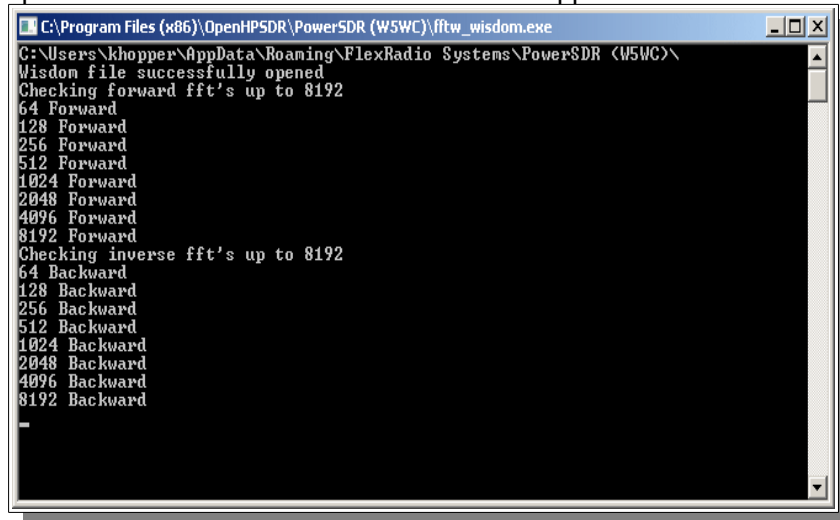

```

C:\Program Files (x86)\OpenHPSDR\PowerSDR (W5WC)\ftw_wisdom.exe
C:\Users\khopper\AppData\Roaming\FlexRadio Systems\PowerSDR (W5WC)\
Wisdom file successfully opened
Checking forward fft's up to 8192
64 Forward
128 Forward
256 Forward
512 Forward
1024 Forward
2048 Forward
4096 Forward
8192 Forward
Checking inverse fft's up to 8192
64 Backward
128 Backward
256 Backward
512 Backward
1024 Backward
2048 Backward
4096 Backward
8192 Backward

```

- Wait for the message that it is OK. select "OK" to finish. This may take several minutes on a slow computer.
- Connect your Transceiver to your Power Supply using the supplied fuses.
- Turn on your **power supply**. Push the **POWER ON** button on the ANAN Transceiver. The IDLE receiver current of the ANAN-10 is approximately 800ma (0.8A)
- Open the PowerSDR application, then press the **POWER** button on OpenHPSDR/PowerSDR™.
- Wait a few seconds for **Network Discovery** and then click on the **Setup Menu** selection.
- Click on the **Setup** menu selection to configure the OpenHPSDR/PowerSDR software.
- OpenHPSDR/PowerSDR basic display screen

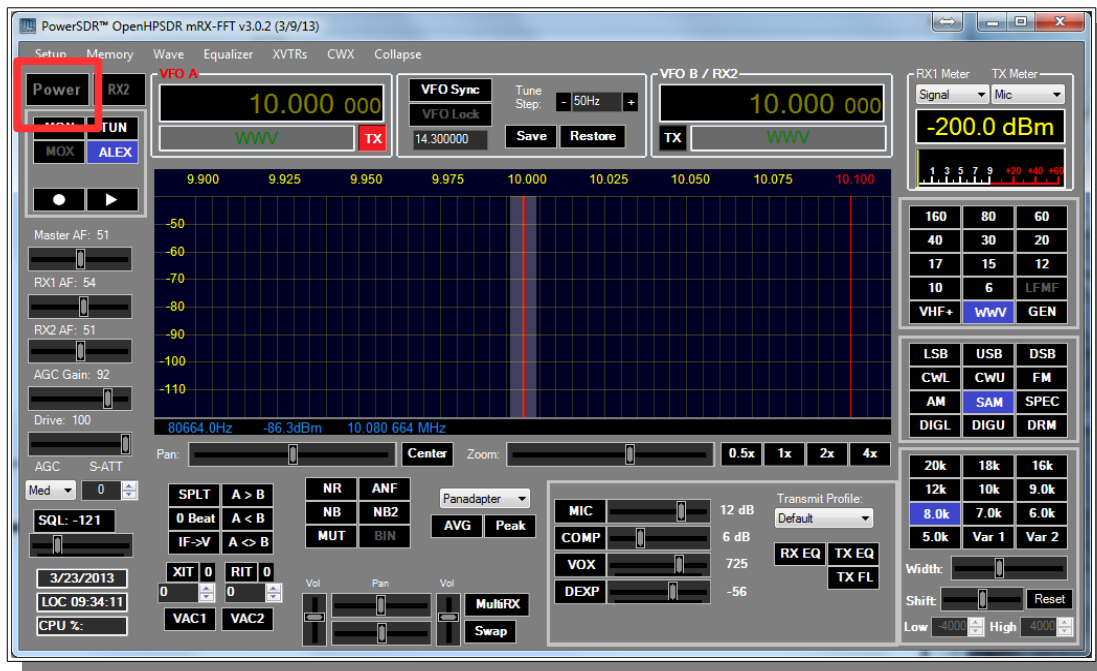

note: if you get in trouble with settings and wish to RESET your SYSTEM to it's initial state, look at the bottom of the Setup Menu for the "RESET DATABASE" option. This will over-ride and install a new database with proper default settings for your ANAN-10. This can be done at any time. However, it will over-write any special personalization that you might have selected – such as Panadapter color, Display speed in frames per second etc.

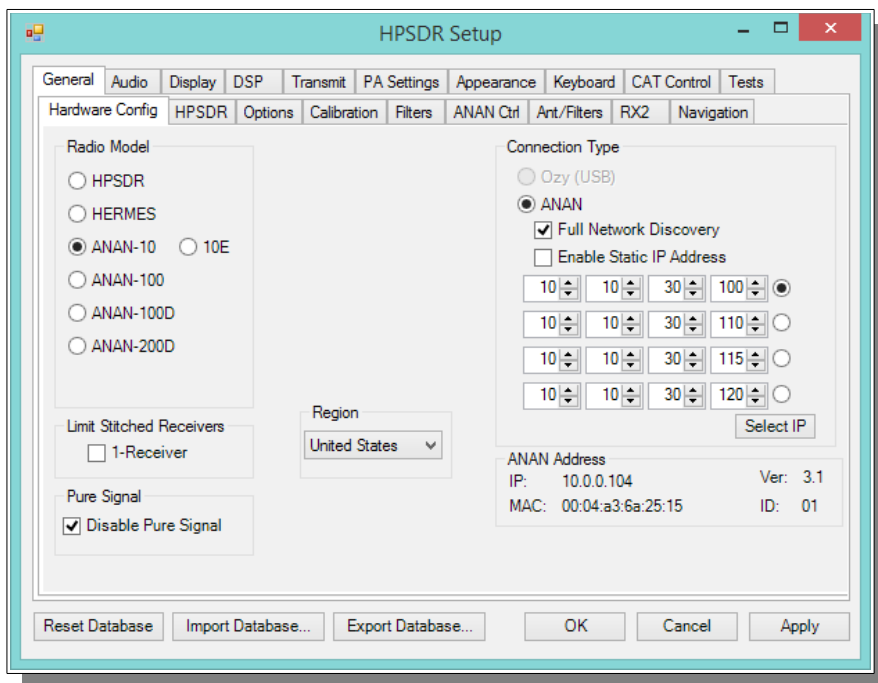

Go to → GENERAL → Hardware Configuration tab and note the IP Address and MAC address that are read from the ANAN Transceiver Transceiver.

Note: if the IP ADDRESS is 0.0.0.0 then the software is not communicating with the Transceiver

- you must check your LAN connection.
- OpenHPSDR/PowerSDR/OpenHPSDR software has not been started
- Power button on the rig has not been activated

Also check your LAN connector on the ANAN Transceiver to insure that the Link Light on the LEFT side of the LAN connector is illuminated.

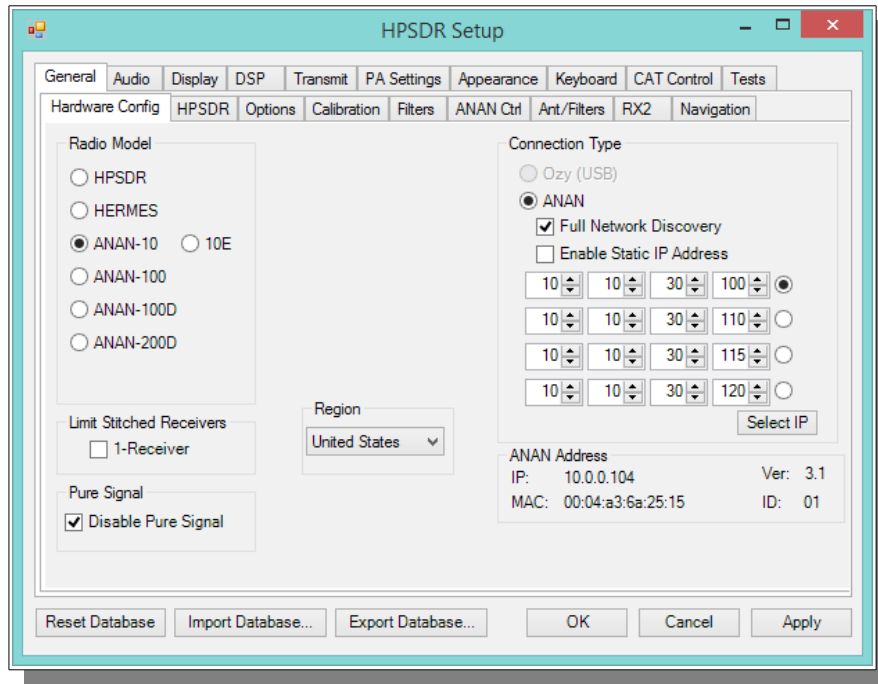

Make a note of your ANAN Transceiver unique MAC address since this will be useful if there is a need for network problem-solving in the future.

 **Note:** Make sure you have selected the proper radio model from the selections on the LEFT side of the Hardware Configuration box. Failure to do so will result in an improper set of menu options and displays.

The Static IP Addresses are available to point your instance of OpenHPSDR/PowerSDR/OpenHPSDR to a particular Apache Transceiver. There may be several Transceivers on your LAN and the Static IP address is a convenience for pointing this software to a particular unit – where each unit has its own IP address.

Setup ---> General tab ---> Hardware Config tab, the Radio Model should have ANAN Transceiver selected. Connection Type “**ANAN**” and “**Full Network Discovery**” should both be checked. In the “**Region**”, select the Country in which you reside.

The ANAN IP address and Firmware version number in the green box highlighted above will be set automatically by your network router DHCP server, or if connected directly to your PC, the IP address will be assigned by the “APIPA” process – WHICH MAY TAKE UP TO SEVERAL MINUTES TO ASSIGN AN IP ADDRESS.

 If your LAN is properly configured, the ANAN Transceiver board IP ADDRESS and MAC ADDRESS should be automatically be detected and assigned. An incorrect default value is 169.254.1XX.XXX. OpenHPSDR/PowerSDR™ will display the currently assigned IP address and MAC address of the ANAN Transceiver Hermes board if the LAN connection is properly connected and configured. If the ANAN Transceiver IP ADDRESS remains 0.0.0.0 then you must determine if OpenHPSDR/PowerSDR and your PC network connection is operating correctly. Some typical problems could be that the Ethernet connection to your PC or LAN connector is disabled in Windows. The Ethernet connector may not be properly seated in your PC or Router. DHCP addressing must be properly enabled on your router. The new HPSDRProgrammer V2 utility allows you to assign a STATIC IP ADDRESS if you wish. Please see APIPA appendix of this document for more information.

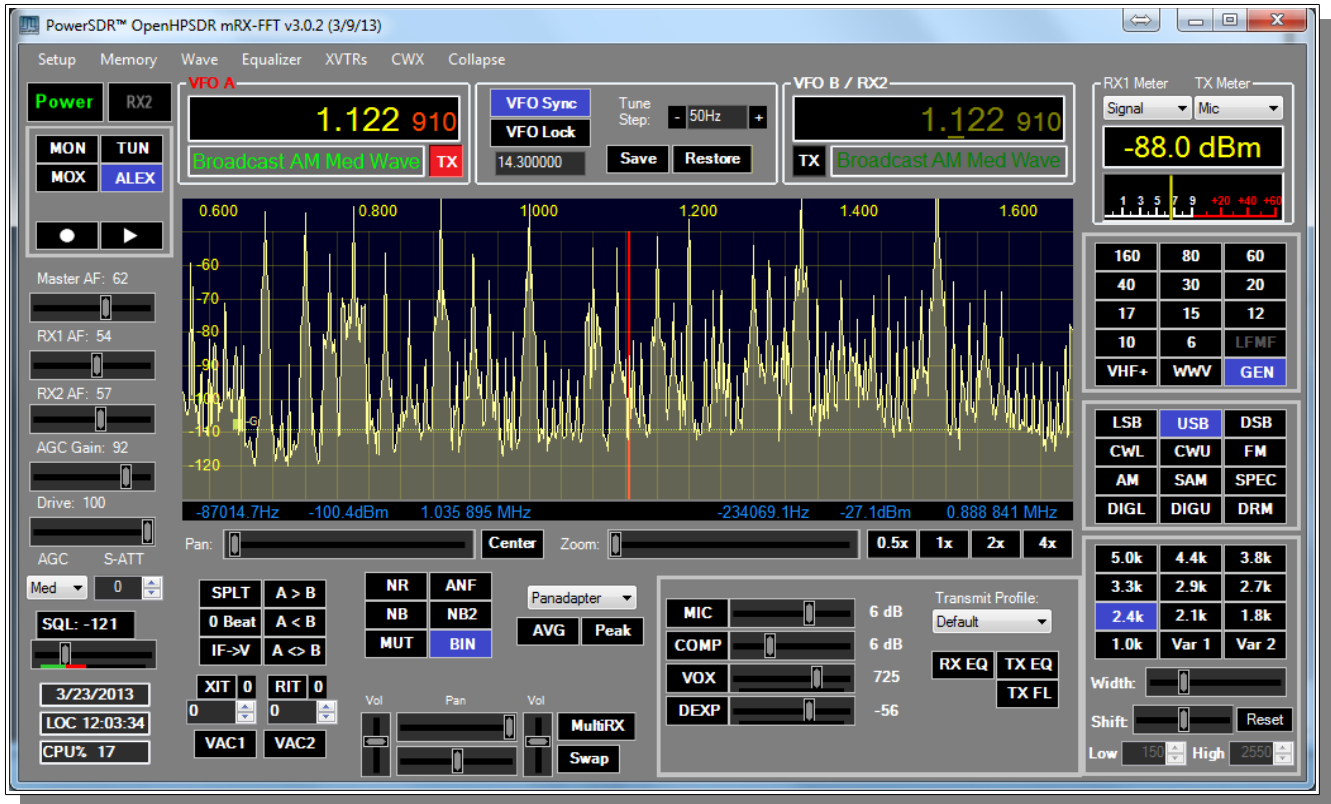

The cluttered and dense Chicago AM Broadcast band shown using 3 x 384khz for RX1

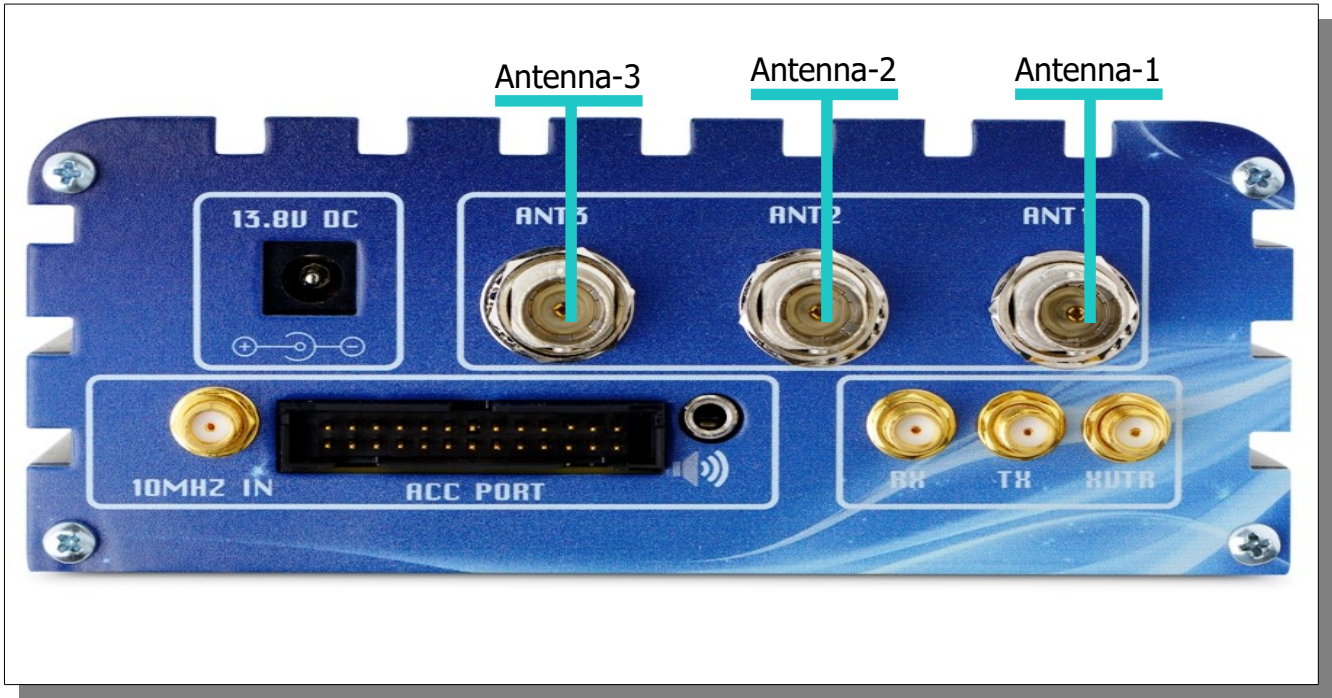

ANAN-10 Rear Panel Connections

Antenna Connections

The Anan 10 provides multiple ways a user can connect antennas and provides great flexibility with numerous options for transmit and receive. Three (3) different Antennas can be connected to the back of the Anan 10 and be configured to support send or receive on all or a selection of bands by each Antenna. This can be configured on the Ant/Filters tab and additional configuration detail follows later in this manual.

Your Anan assumes a 50 Ohm standard antenna will be connected to Ants 1-3. The Anan-10 does not have a built in Antenna tuner and therefore unless your antenna's have a resonant 2:1 SWR, an external tuner should be used to optimized antenna SWR and performance.

The Anan by default provides limited isolation between the Ant 1, Ant 2 and Ant 3 connections by sending the signal to ground and attenuating the receivers input during transmit. Additional attenuation can be selected via the ATT to TX setting on the Ant/Filters tab in PowerSDR MRX Settings.

A very nice feature of the Anan-10 is it's ability to monitor your transmit signal on the receivers while transmitting. If you select DUP (DUPLEX] on the main screen in PowerSDR MRX the transmit signal will be visible on the Panadapter while you transmit allowing you to visually monitor your signal. You must be in Panadapter or Panafall modes to see your signal.

Chapter 3 – How to operate SSB Phone

You need to accomplish the following;

- Proper installation of PowerSDR software
- Proper installation, power supply, and normal operation of your ANAN-10 Transceiver as indicated in the PowerSDR software windows.

Connecting a suitable Microphone

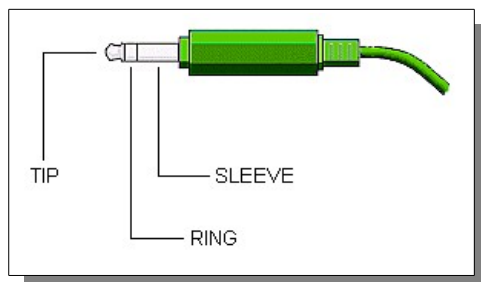

Most "Computer Condenser" microphones will work when directly plugged into the MIC connector on the front panel of the Apache Transceiver. The Factory settings for Apache Transceivers is to have a small positive voltage applied to the **TIP** of the connector for **powering a condenser microphone**. The **RING** is connected to **push-to-talk**, and the **SLEEVE** is connected to the Transceiver analog ground. The **SPACE BAR** of your keyboard acts as the **default push-to-talk** for all microphones. A Computer Condenser mic without a push-to-talk switch can easily be used by substituting the **SPACE BAR of your KEYBOARD**.

Example: here is a link to a \$3 USD microphone using the keyboard space bar for push-to-talk:

<http://www.officedepot.com/a/products/969486/Cyber-Acoustics-ACM-51-Boom-Microphone/>

MIC Adapters

- A Ham style, multi-pin microphone requires an adapter. Various adapters are readily available or can be wired to the Apache 1/8" Stereo style MIC socket.

<http://www.ebay.com/itm/like/191566170362?pid=82&chn=ps>

<http://www.gigaparts.com/Product-Lines/Microphone-Adapters/Icom-Mic-Adapter-for-Apache-Labs-Transceivers.html>

- The original ANAN Users Guide has several detailed paragraphs about adapters. The Apache Labs Yahoo Group Files section also has good information about MIC connections and alternatives such as **Headsets** using a **Virtual Audio Cable [VAC]** utility or "**VB-Audio**".
- If you find that you need to change internal jumpers in the ANAN-10, you can refer to the diagram below that is published by Phil Harman VK6PH in his Hermes documentation:

http://svn.tapr.org/repos_sdr_hpsdr/trunk/Hermes/Documentation/Hermes_User_Manual_V1.19

- Microphone Connector Database
<http://www.qsl.net/g4wpw/date.html>

If you wish to use a headset, you will need to install a Virtual Audio Cable utility [VAC] or VB-Audio and set it appropriately in the Setup ---> AUDIO ---> VAC1 or VAC2. Please refer to helpful documentation for VAC in the Files section of the Apache Labs Yahoo Group <https://groups.yahoo.com/neo/groups/apache-labs/>



Subject: [apache-labs] PowerSDR_mRX Audio Chain - How it works

From: Warren C. Pratt <warren@wpratt.com>

There has been quite a bit of discussion lately of MIC sensitivity and the audio processing in the mRX release. I think a few words of explanation about how things work might be helpful to those exploring various situations and alternatives.

In the case audio enters the MIC connector, it is fairly quickly routed to an audio CODEC to be converted to digital samples. Within that chip, before the ADC, there is a 20dB gain block that can be switched OFF/ON. This gain block is the 20dB Mic Boost that can be selected. Although I haven't tried, I suppose it's possible to overdrive the input stages or

ADC (especially with the 20dB gain block enabled] which could result in clipping of the digital data and resulting distortion.

After conversion to digital, the 16-bit, 48Khz samples are transferred to the computer where they are promptly converted to floating point. With floating point samples, dynamic range is of little consequence as they then progress through the digital signal processing chain. The processing chain is then as follows:

MIC GAIN - a simple multiplier determined by your gain settings is applied to the samples.

DOWNWARD EXPANDER - If activated, the signal is reduced in gain if it is below the threshold set on the console.

GRAPHIC EQUALIZER - If activated, a filter is applied to the audio. The frequency response of the filter is tailored to the response curve that has been set.

LEVELER - If activated, the specified leveler gain is applied to the audio if/when the signal level is running below the leveler's output target amplitude. I currently have the output target set to +0.4 dB. Why not 0 dB? The slight positive bias is beneficial for upcoming features. (Note: NOT the same algorithm that Flex used.)

COMPRESSOR - If activated, the specified maximum compression is applied. Output is compressed to 0dB maximum. (NOTE: Not the compander algorithm that Flex used.)

FILTER - The audio is filtered to match the transmit bandwidth.

ALC - The audio is restricted to 0dB so as not to over-drive the fixed-point dynamic range of the FPGA and/or the DAC. (NOTE: Not the same algorithm used by Flex.)

Finally the audio is converted to 16-bit, 48Khz, samples and transferred to the hardware for up-conversion.

What happens if you run your MIC level above 0dB? If the Leveler is ON, you will get some compression there and everything else runs as normal. If the Leveler is NOT on but the compressor IS, you will get some additional compression there, above the value you have selected. If neither the Leveler or Compressor is ON, you will get some compression by the ALC. IN NO EVENT does the compression cause "flat-topping" or "splatter." These phenomena only result from non-linearity and overdrive of the analog amplifiers. Note that the ALC has no knowledge of the analog amplifiers--it is strictly in the digital signal

processing chain.

73,

Warren NROV

Setting up PowerSDR for Phone Operation

With the rig powered on and PowerSDR software running, you should hear great audio from your speakers or headphones connected to the front panel "headphone" jack. Tuning methods are covered on page 38.

Select modulation mode of **USB** or **LSB** at the right, center of the OpenHPSDR/PowerSDR window.

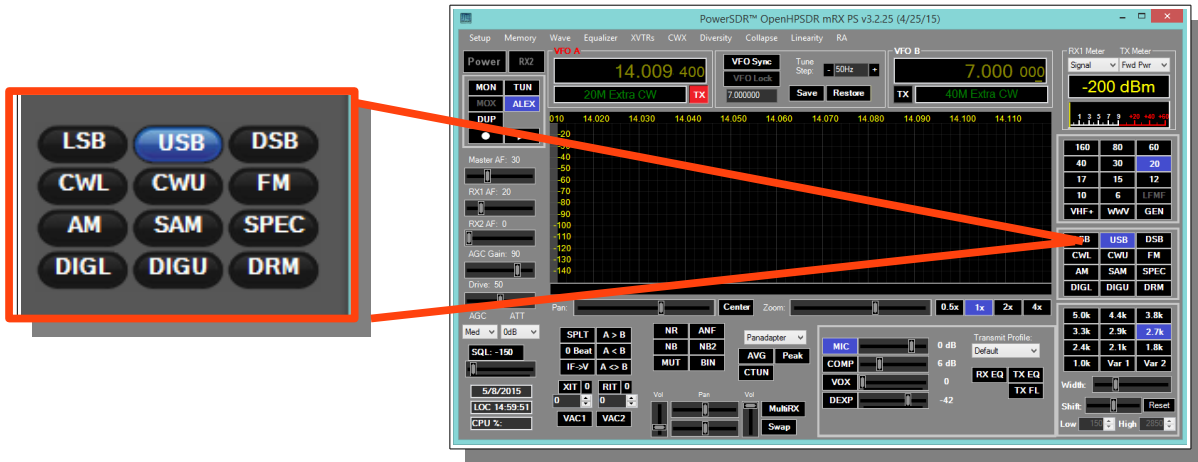

Selecting Transmit Profile

The "Profiles" drop down menu allows you select various transmit profiles. The default profile is "Default". You can modify profile settings on this tab and save them to a profile name you select, or you can just modify the included profiles to your liking. You can recall saved profiles at a later time.

Adjusting mic gain

The internal jumpers JP4, JP5, and JP6 on the Hermes board need to be set properly for the type of microphone used. The default is a simple Condenser mic plugged into the front MIC jack. See the reference section of this document for the jumper settings, or refer to the document by Phil Harman VK6PH: http://svn.tapr.org/repos_sdr_hpsdr/trunk/Hermes/Documentation

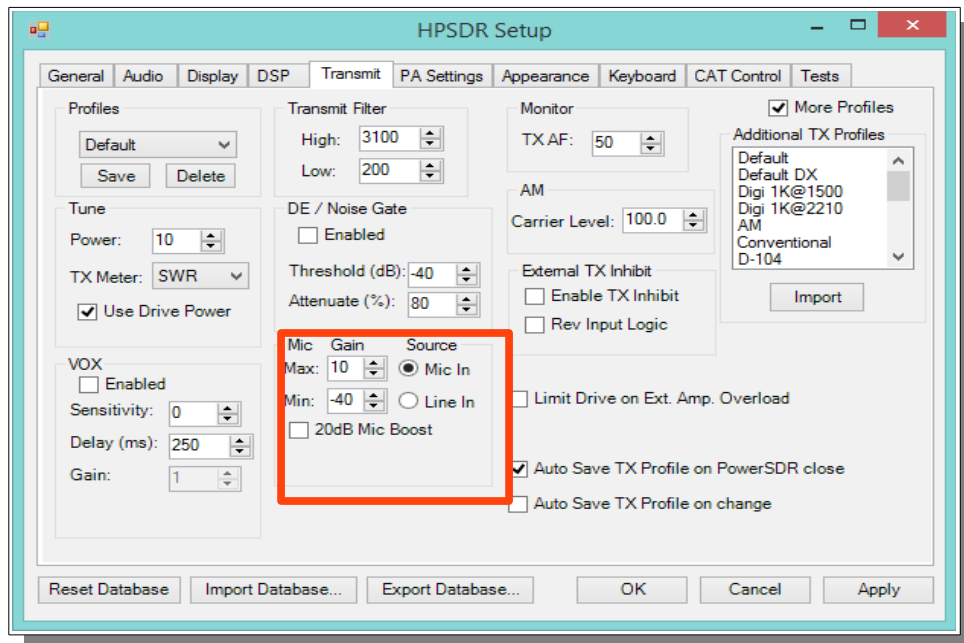

- You should make all microphone adjustments using a **Dummy Load**.
- Select Setup → Transmit the default Source is **"Mic In"**.
- Locate the "MIC" gain control slider. It is located at lower right, below the panadapter. The present mic gain setting is shown just to the right of the MIC gain slider.

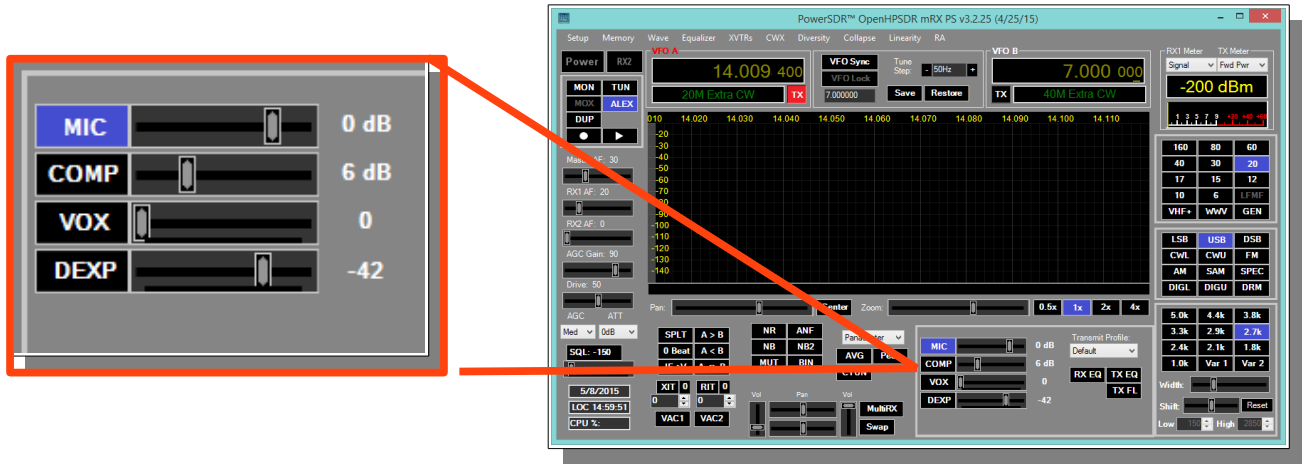

- On the OpenHPSDR/PowerSDR main window, use the "TX meter" (Upper right corner] dropdown box to select "Mic".
- Press your Mic PTT button, keyboard space bar, or click the "MOX" button on the main form to key the radio. With the radio keyed and while speaking into the mic in a normal voice adjust mic gain for peaks 0db.

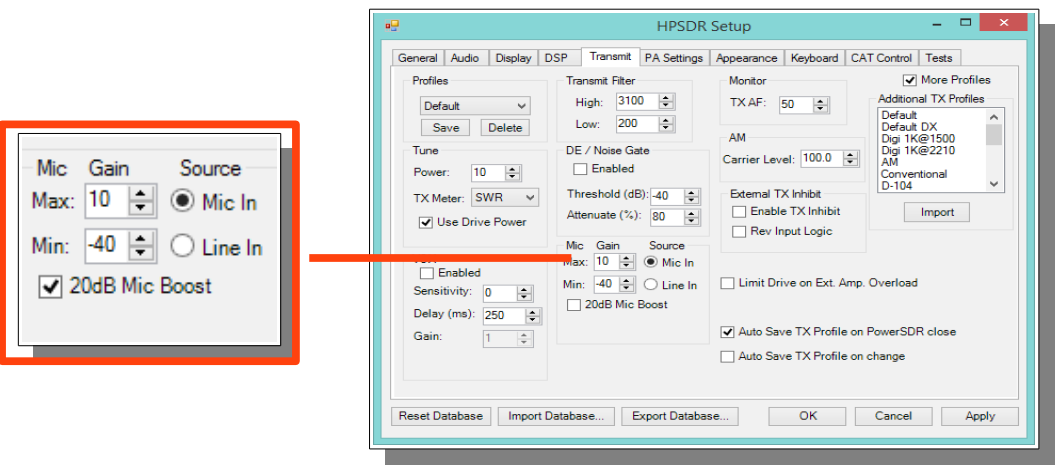

- If 0 db voice peaks cannot be achieved with the slider at the extreme right, go to the Setup, transmit tab (lower left], check **"20db mic boost"** and try again to adjust the "MIC" gain control on the main OpenHPSDR/PowerSDR window for 0 db on voice peaks.
- If you are still unable to achieve 0 db on voice peaks:
 - [a] Check your JP4, JP5 and JP6 jumper settings on the Hermes board.
 - [b] Try a different mic.
- To enable or disable COMPRESSION you click on the COMP button. We recommend that you set COMPRESSION to no more than 6dB.

Transmitting

Tune

- The "Tune Power(%]" spinner allows you to select the power output used when the "TUN" button is pressed on the main OpenHPSDR/PowerSDR window. In some versions of OpenHPSDR/PowerSDR, this is actually a percentage of power output rather than output in Watts. The "Tun" button places OpenHPSDR/PowerSDR in CW mode and keys the transmitter using the specified power output level.
- The "TX Meter:" drop down selects what the TX Meter on the main form displays when the "Tun" button is pressed.

VOX

- Click the "enabled" button to enable "Voice Operating Transmit" if you want to cause the transmitter to key when you speak.
- Set the sensitivity spinner to a higher value if you wish to have a higher voice level cause the transmitter to key.
- Set the delay to cause the VOX to de-key the transmitter after not hearing voice for "Delay (ms]" milliseconds.
- Use this with care. Local noises (dog barking, TV playing, door bell, computer sounds] can cause your transmitter to key when you do not want this to happen. Extreme cases can cause your transmitter to key for excessive periods of time resulting in damage to your radio and attached power amplifier.

Transmit Filter

- This filter tailors the transmitting frequency response in voice modes.
- The default for high is 3100hz in some versions of OpenHPSDR/PowerSDR.
- This value exceeds the frequency response allowed on 60 meters in some regions.
- You can modify this and other values as needed before hitting the "Save" profile button to save to disk for later recall.

HPF/LPF Filters and switching in ANAN Transceiver

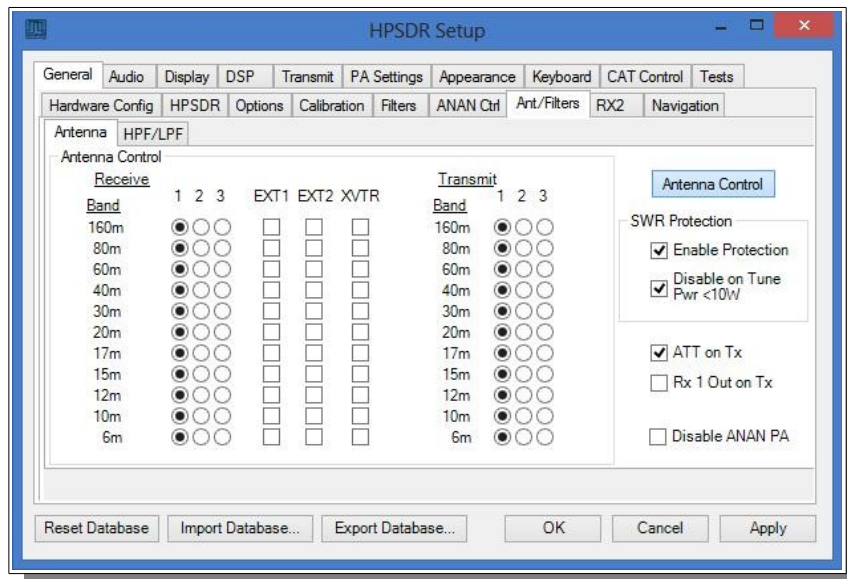

- The ANAN-10 has a very effective set of High Pass Filters (HPF) and Low Pass Filters (LPF), available on the Setup, General, Ant/Filters/HPF/LPF tab. The HPF and LPF are automatically selected as you change bands, according to the settings on this form.
- The ByPass check box on the left side of the HPF/LPF tab, when checked, removes the selected high pass filter from the receive path.
- The values in the up/down boxes control the frequency ranges when these filters are automatically selected.
- The 6m BPF/LNA bypass check mark controls the 6 meter low noise amplifier and filtering.
- The **ByPass**/55mhz HPF check mark, when enabled **bypasses** all high pass filters.
- The active buttons displayed between the HPF and LPF show which filters are currently active.
- The Auto/Manual radio buttons should be left in Auto mode for most operations. Selecting manual will allow you to see what receive filters are selected when you bypass or change receiver frequency ranges etc.

Antenna Control menu allows you to control the following options:

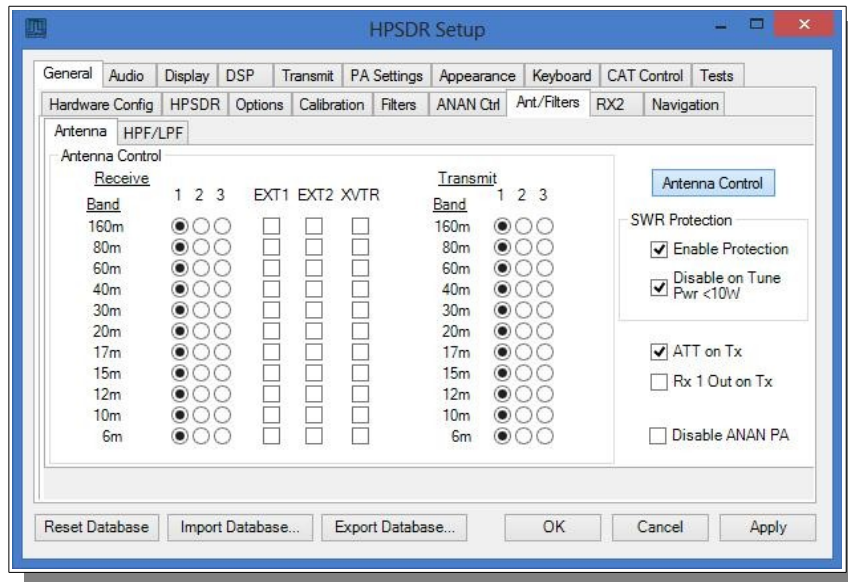

- Software SWR Protection will reduce power output when high SWR levels are detected.
- Disable on Tune Pwr < 10W will disable Software SWR protection when the Tune power level is less than 10 watts. The Tune power level can be set on the Setup, Transmit tab.
- ATT on TX. This option inserts attenuation in the receiver when the ANAN-* is transmitting. This can prevent or reduce the ADC/Receiver overload warnings during transmit.
- RX 1 Out on Tx. This option switches the receive path from ANT(n] to the rear panel Bypass connector.
- Disable ANAN PA (only functional via the XVTR form].ANAN-10 users may wish to manually calibrate the Transmitter Power Output settings within OpenHPSDR/PowerSDR™ OpenHPSDR/PowerSDR/OpenHPSDR allow small adjustments of transmitter power output.

Chapter 4 – How to operate Digital modes

Clarification CCS (3W)/ICAS (10W) operation

AM/FM, **CCS** (Continuous Commercial Service] **3W**

SSB, CW and all **ICAS** modes (Intermittent Commercial/Amateur Service] **10W PEP**

The Power Amplifier MOSFET transistors have characteristics that far exceed the needs of normal Transceiver operation. They are quite rugged. However, other internal components such as the Filters, Integrated Circuits, and some small SMT parts must also be considered when modes with high duty cycles are in use. There are three voltage rails all of which have thermal shutdown protection built in.

Digital modes such as PSK31, RTTY (AFSK), WSPR, JT65A work very well with PowerSDR control software and Apache Transceivers.

Digital operation of a Software Defined Radio may require additional Utilities and supporting software in order to complete the complex software (virtual) interconnections for digital operation. Fldigi will be used as an example.

There are dozens of high quality, digital programs available:

Helpful catalog of Ham Radio digital software: <http://www.dxzone.com/catalog/Software/>

Dxzone Software Catalog

W1HKJ Fldigi

VSP, Com0Com, RigCAT, Omni-Rig, VAC, VB-Audio

- **W1HKJ Fldigi** <http://www.w1hkj.com/FldigiHelp-3.21/html/index.html>
- **Virtual Audio Cable** or **VB-AUDIO** connections can easily be accomplished with the \$25-\$40 program called "VAC" or the VB-AUDIO virtual audio cable
 VAC is available here <http://software.muzychenko.net/eng/vac.htm#download>
 VB-Audio is available here: <http://vb-audio.pagesperso-orange.fr/Cable/>
 VB-Audio Mixer here: <http://vb-audio.pagesperso-orange.fr/Voicemeeter/index.htm>
- You may also need **virtual Serial Ports** to interface software PTT connections. Here are two popular Utilities:
http://k5fr.com/ddutilwiki/index.php?title=VSP_Manager
<http://sourceforge.net/projects/com0com/>
- The **Apache Yahoo Group** has several helpful digi operating documents:
<https://groups.yahoo.com/neo/groups/apache-labs/files>
 SignalLink-Hermes-WiringDiagram.pdf
https://xa.yimg.com/df/apache-labs/PowerSDR-Fldigi_Guide_V2.0.pdf
- The **KC9XG Yahoo Group** also has many helpful diagrams and documents:
<https://groups.yahoo.com/neo/groups/KC9XG-SDR/files>
- Various libraries such as **ComCat, RigCat and Omni-Rig** may be necessary for CAT (PTT and VFO) control:
<http://www.dxzone.com/tag-rig-cat-control/>
<http://www.w1hkj.com/download.html>

Chapter 5 – How to operate CW

Sample Rate

- Select a **SAMPLE RATE** best suited to your CW tuning style from the **Settings → AUDIO** menu

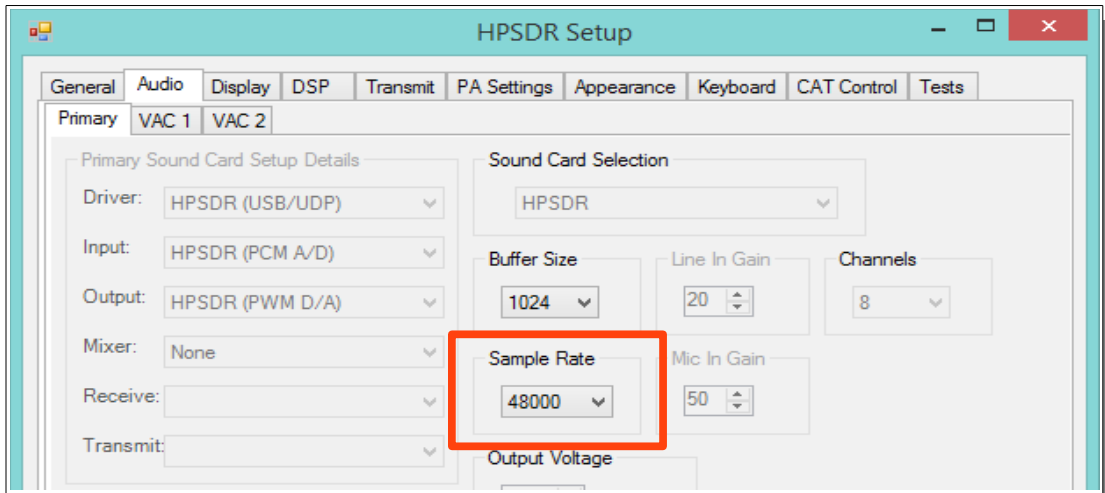

Note: the appearance of the Panadapter can be adjusted with the **ZOOM** settings, **Sample Rate**, and **SETUP --> DISPLAY --> RX1 (or RX2) --> Fast Fourier Transform Size** (min to max] Bin width.

Iambic A/B

- Select Iambic A or B from the **Settings → DSP → CW** menu

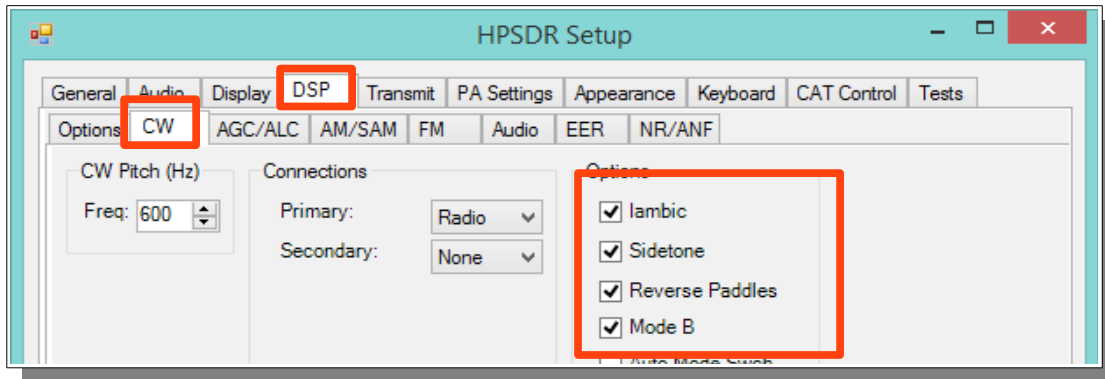

Note: Unselecting Iambic allows you to use the Paddle input in **"Bug"** mode or with a **Straight Key** connected to the **DAH** paddle input.

Paddle Connection

- Plug your favorite paddles into the front panel using a standard **1/8" Stereo Plug**.



To use a CW key with OpenHPSDR/PowerSDR™ you will need to enable it in the menu. To do so, click on Setup → DSP tab followed by the Keyer tab.

Provides connection for a CW key, either straight, single-paddle or Iambic. If using dual-paddle or Iambic mode, the common connection of the key should be made to the sleeve of a 3.5mm 1/8" stereo plug, the "dot" side to the ring and the "dash" side to the tip. If a straight key is used, this should be connected between the sleeve and the tip of the plug. PowerSDR Software enables the dot and dash connections to be reversed via a menu selection (above). The dot and dash connections are connected to a 3.3vdc via a 1k resistor.

If you find that your DAH and DIT **paddles** are **reversed**, there is a very convenient **SETUP** check box to put DAH on tip and DIT on Ring of the input **PLUG**

CWU/CWL

- Select **CWLower** or **CWUpper** from the **MODE** buttons in the main window. Note the position of the filter changes in the main window.

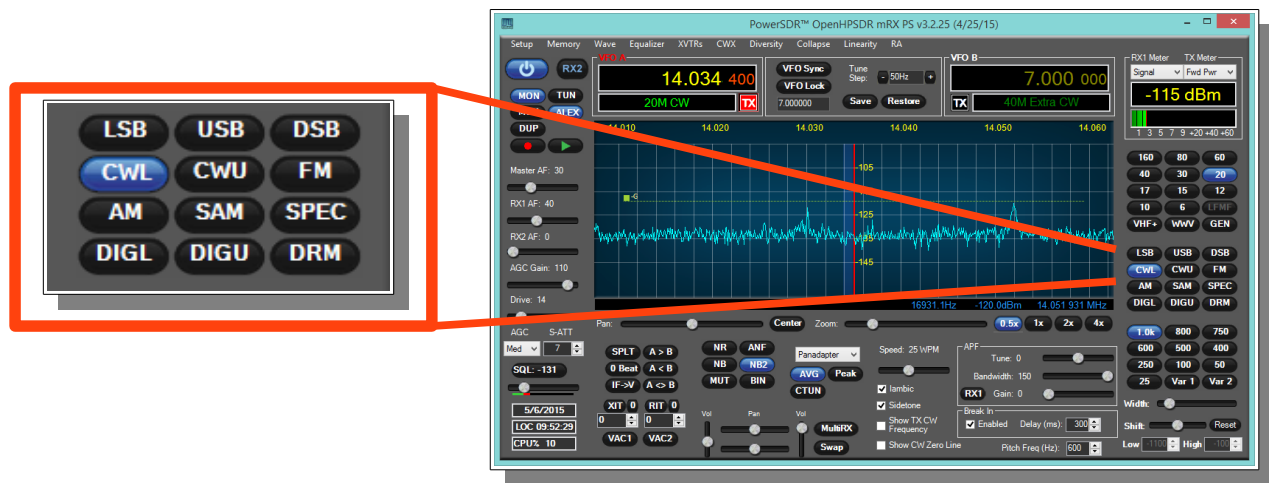

Select Operating Frequency

- Using your mouse on the PANADAPTER display, **select your operating frequency.**

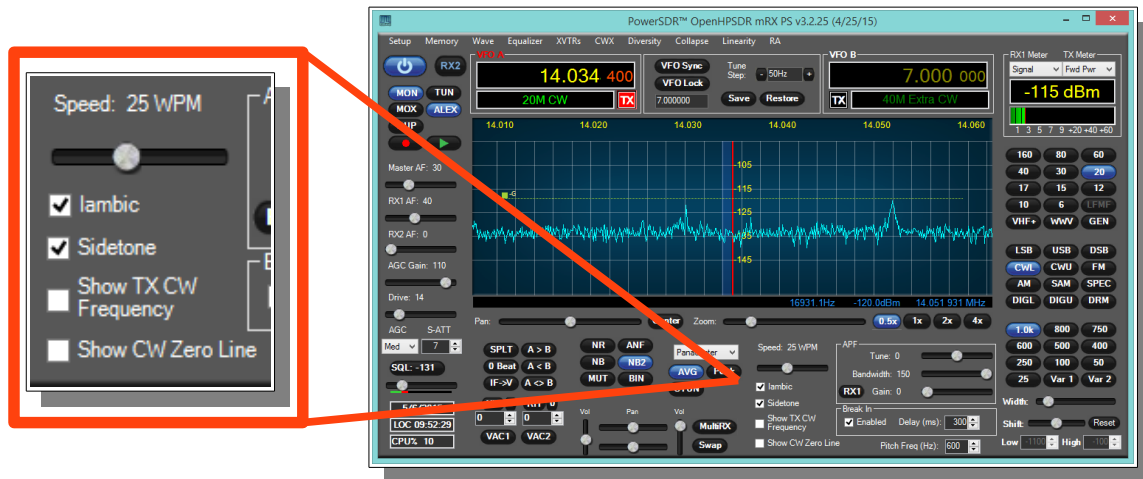

Note that you can see your **CW (BFO) CENTER FREQUENCY** or **TX FREQUENCY** by checking the boxes on the main screen. Those convenient vertical yellow marker-lines are really great when you are working split. The **SPEED** of the internal Iambic Keyer is shown at the top of this picture.

Set Drive Level

- Set the **DRIVE LEVEL** slider to 50% (mid range).

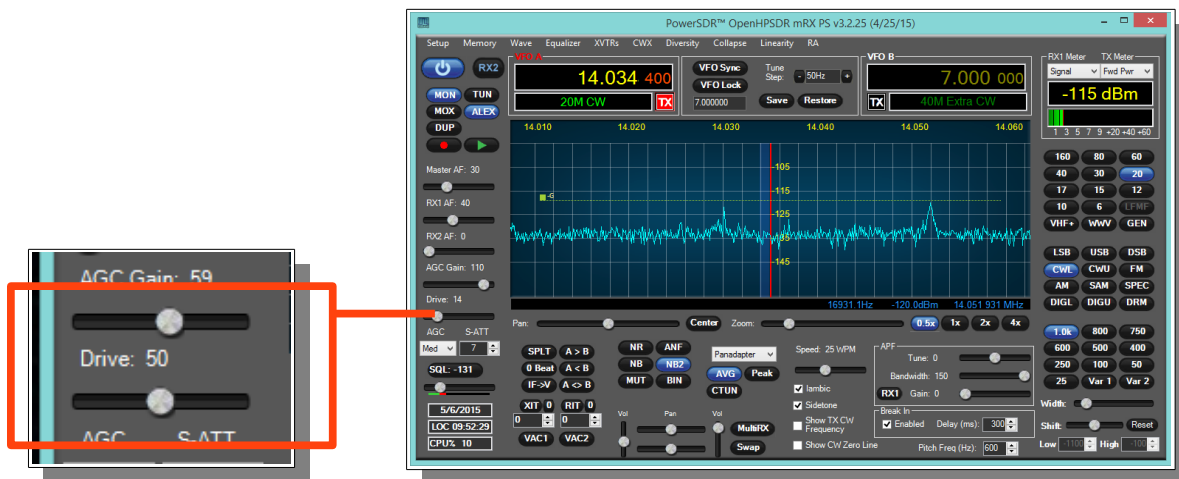

Break-in Delay

- You may wish to start with the default CW DELAY setting of 300ms. That value gives you plenty of time to complete words without tripping the T/R circuit at 20WPM. Set the DELAY to a value that best suits your comfortable operating speed.

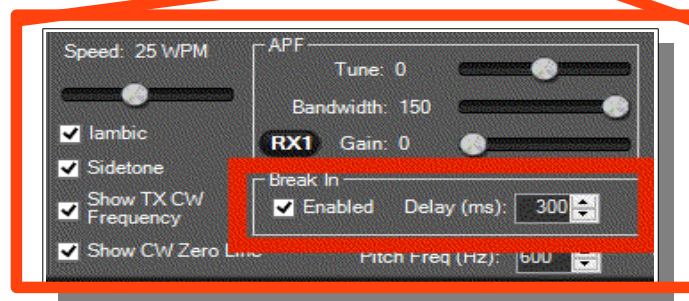

QSK

Do not expect fast QSK. At a later time, you can adjust SAMPLE RATE, DSP buffer sizes and DELAY for faster T/R when you are more familiar with the PowerSDR software. There are good references for QSK at these websites:

<http://anan-100d.wikidot.com/>

<http://www.w1aex.com/anan/anan.html>

<https://groups.yahoo.com/neo/groups/KC9XG-SDR/info>

<https://sdrzone.com/>

Sidetone Level

- On a Dummy Load try sending some code and see if the **sidetone** is at a comfortable level. The

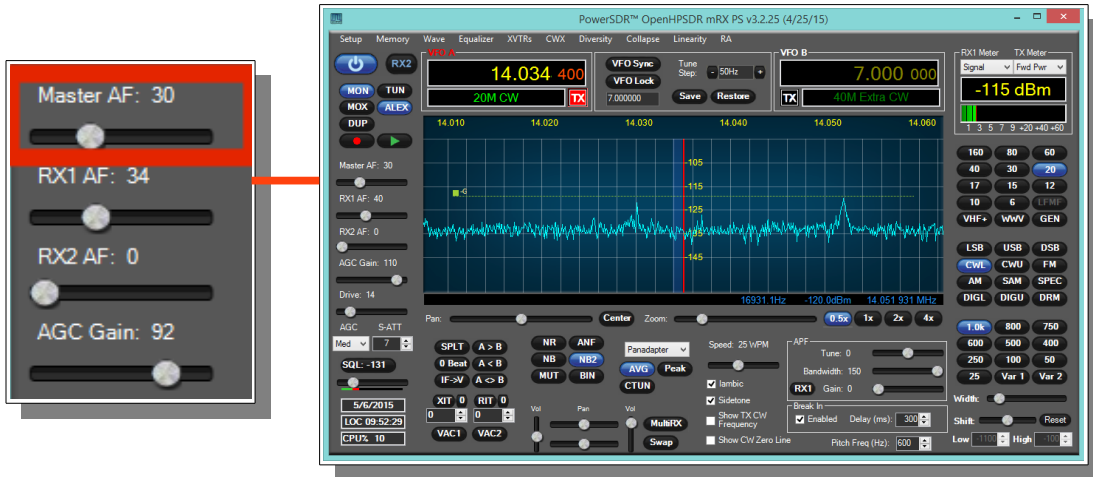

MASTER VOLUME slider (upper left) is ALSO the SIDETONE LEVEL setting when you are in **Transmit**.

Antenna

- Connect a good antenna (that is resonant on your favorite CW band] to ANT-1

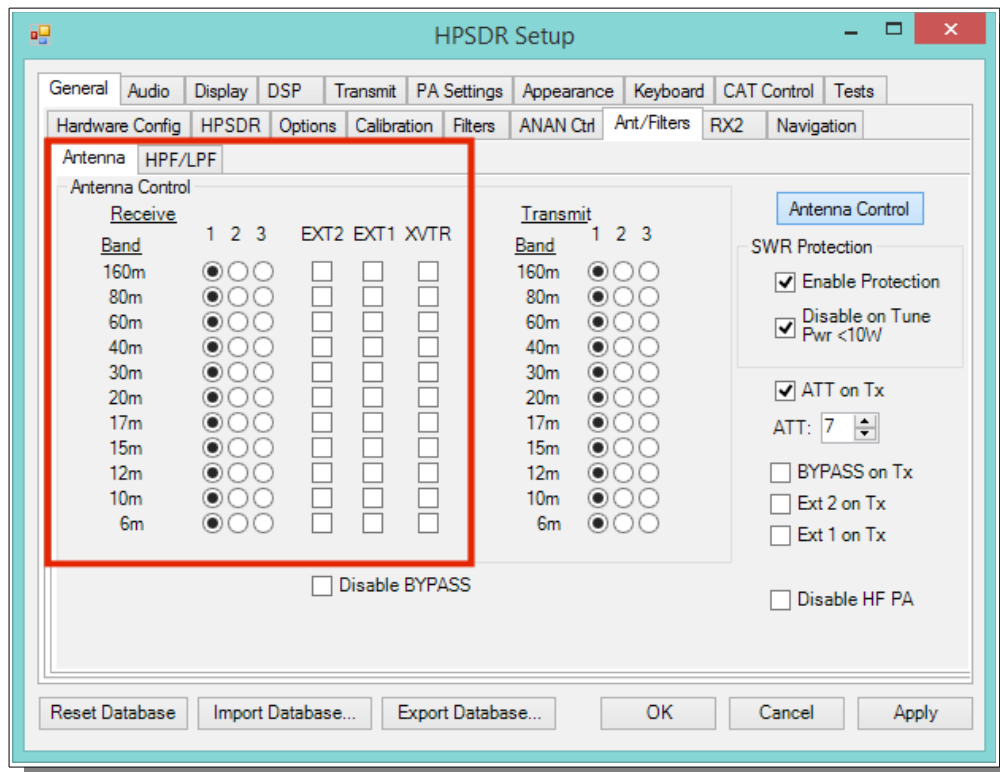
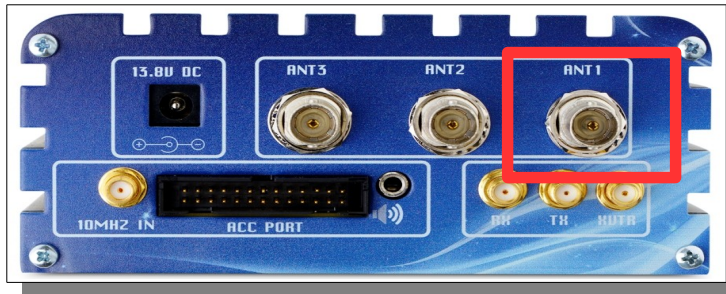

Use the Antenna Control settings DEFAULT values until you have more experience with your new Transceiver.

Note the Antenna Control menu allows you to control the following options:

1. Software SWR Protection will reduce power output when high SWR levels are detected.
2. Disable on Tune Pwr < 10W will disable Software SWR protection when the Tune power level is less than 10 watts. The Tune power level can be set on the Setup, Transmit tab.
3. ATT on TX. This option inserts attenuation in the receiver when the ANAN-* is transmitting. This can prevent or reduce the ADC/Receiver overload warnings during transmit.
4. RX 1 Out on Tx. This option switches the receive path from ANT(n] to the rear panel Bypass connector.
5. Disable ANAN PA (only functional via the XVTR form]



Tuning

- Methods for tuning your Transceiver to a frequency

Direct numeric input

Keyboard commands – see Setup → Keyboard menu

Point and Click with Mouse

The mouse can be used to tune signals on the Waterfall or Panadapter. Select an active amateur band by clicking on one of the band buttons located just below the "S Meter" in the upper right portion of the OpenHPSDR/PowerSDR window.

If you press and hold the left mouse button you can "drag" the frequency of interest into the panadapter highlighted filter area.

If you right click the mouse on the Panadapter you can go into "click tune" mode. The display will show a yellow indicator tuning line and filter width setting. Left clicking with the mouse will then QSY the receiver to that frequency. You can right click again to revert from "click tune" mode to "drag" tuning mode.



The "Zoom" slider and the "0.5x, 1x, 2x and 4x" buttons can be used to modify the frequency range displayed in the Panadapter. These controls are located just below the Panadapter/waterfall display. The "Pan" button can be used to move the displayed frequencies within the selected range.

Drag Mouse

Roll Mouse Wheel – see main window TUNE STEP selections

Methods for tuning your Transceiver to a frequency - continued

CTUNE

The PowerSDR "CTUN" button enables "Click Tuning" while using the panadapter and waterfall displays. "Click tuning" when active, allows you to click within the Panadapter or waterfall to QSY without shifting the Panadapter or Waterfall display. When "CTUN" is inactive, clicking on the Panadapter re-centers the panadapter, thereby shifting the entire panadapter. Note that the "CTUN" function only works within a frequency range equal to the sample rate. IOW, if the selected sample rate is 384khz and RX1 panadapter is 1 MHz, wide, CTUN will only function within the center 384khz of the panadapter or waterfall display.

DUP

The PowerSDR "DUP" (DUPLEX] button enables RX1 reception during transmit, allowing the user to view the transmitted RF signal in the Panadapter. The ANAN-10 transceivers switch the selected antenna (ANT1, ANT2, or ANT3] to ground during transmit, thereby protecting the receiver from damage due to high RF levels. Monitoring of the RF transmission using the "DUP" feature is visible in the Panadapter and Panafall modes.

LOCK VFO – prevents an unintended change of VFO frequency while in a QSO

Tune/SWR/Output

- Select the TUNE button to see your SWR and OUTPUT wattage on the main screen display. The TX display is in the upper right corner of the main window. Select various meter options to see which one suits your operating style. I frequently use SWR and OUTPUT WATTS when on CW.

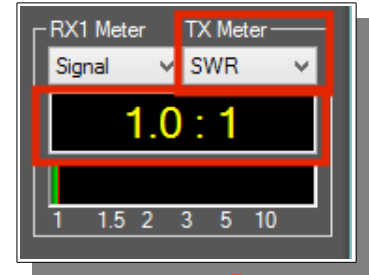
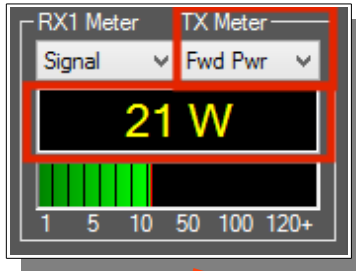

Drive Level

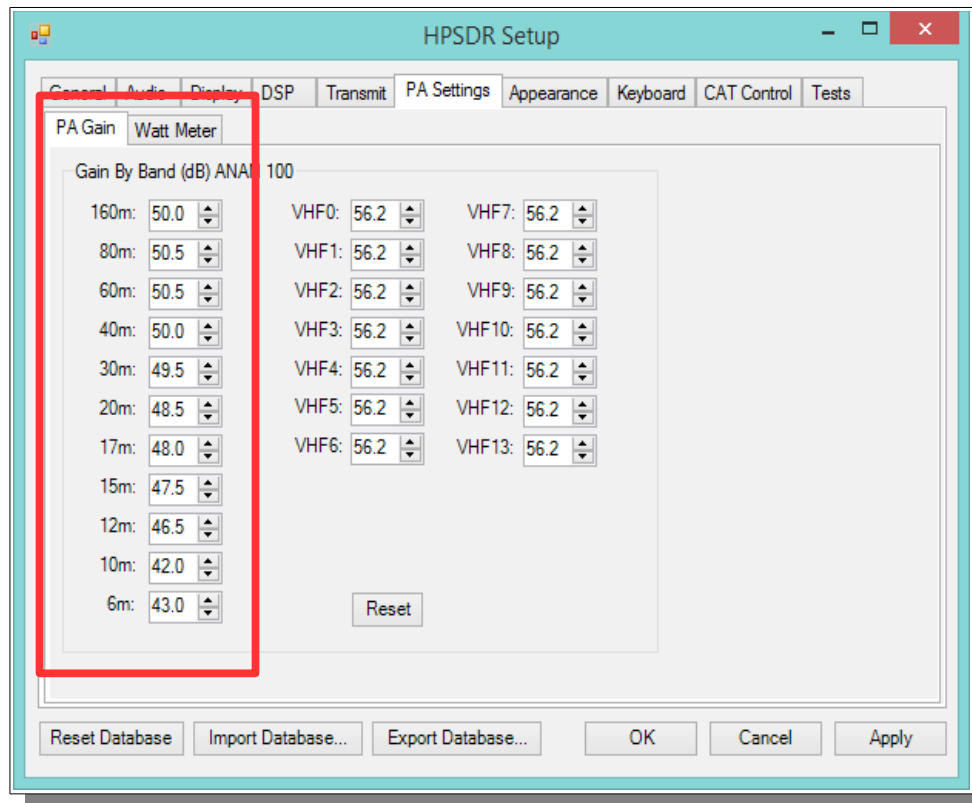

- If you have not yet completed a MANUAL PA CALIBRATION, then the output may be a bit above or below your desired **DRIVE** slider setting. The PowerSDR default PA CALIBRATION values are usually very good for most Apache Transceivers. Note: the Drive Level is a percentage and not the numerical watts output.

- Enjoy your first QSO and be sure to share the news with all the CW ops on the Apache Yahoo Group.

<https://groups.yahoo.com/neo/groups/apache-labs/info>

Chapter 6 – How to Interface to your Linear Amplifier

PTT Input

PTT Output

Most modern Linear Amplifiers have a connection for PTT input for keying the Linear. Apache Transceivers include a back panel connection for this purpose and it is activated by the PowerSDR software based on menu preferences. On the ANAN-10 Linear Amplifier PTT OUT it is pin 1 of the AUX I/O Ribbon connector.

FET

The PTT OUT is a common DRAIN 2n7002 type FET transistor as shown in the schematic for the ANAN-10.

The heavy duty type FET is best used to switch **25vdc** and **800ma** (or less). Exceeding these values may damage the PTT OUTPUT circuit.

How to test your PTT Linear Amplifier circuit **BEFORE** connecting your Apache Transceiver.

- Power your Linear, connect the control cable to your linear but do **not** connect the other end to your Apache Transceiver
- Using a **DC Voltmeter**, measure the voltage between the center pin and the outer connection of the cable. This must be less than **25vdc**.
- Connect a **DC Ammeter** between the center pin and the exciter connection of the cable. This should **ACTIVATE** the Linear Amplifier and give you a clear measurement of the current requirements. The ANAN-10 PTT circuit should not draw more than **800ma**.
- If either of these values are out of the required range, then use an external keying interface. There are many keying interfaces available from many sources such as MFJ, Elecraft, DX Engineering.

Important: Connecting a Linear Amplifier that does not meet the above voltage and current requirements is likely to cause damage to the Apache Transceiver linear switching transistor and extreme cases, serious damage to other parts. Damage to the radio caused in this manner is not covered by Warranty.

Various Linear Amplifier Keying ISOLATION are available

<http://www.dxengineering.com/search/product-line/kd9sv-products-sv-kr-keying-relays>

<http://www.ameritron.com/Product.php?productid=ARB-704>

<http://www.sultantronics.com/product.html>

http://stores.ebay.com/radiodan-w7rf?_trksid=p2047675.l2563

ALC

K2UE has written a helpful document about how he uses ALC with his Apache Transceiver. You can find it in the Apache Yahoo Group FILES section:

<https://xa.yimg.com/df/apache-labs/ExtALC+Installation+%26+Use.pdf>

For more information about suitable couplers from the KC9XG Yahoo Group Files section:

<https://xa.yimg.com/df/KC9XG-SDR/PSSamplersCouplers.pdf>

Various directional coupler models are available

ac2iqdave@gmail.com

<http://www.elecraft.com>

<http://www.wavenode.com>

<http://www.cleanrf.com>

In practice, the ANAN-10 works well with PureSignal with no external RF Sampler when running 10W. You will need to determine the suitability of your Linear Amplifier to the modes you wish to operate.

Automatic Band Selection can be accomplished using the Open Collector Output transistors available on the AUX I/O Connector on the back panel. DDUTIL?

VK6PH example OpenCollector BCD keying

This is an example provided by Phil Harman VK6PH of how to code the OpenHPSDR/PowerSDR/OpenHPSDR Power_mRX program to give a BCD (binary coded decimal] output for control of external equipment (such as band information for a Linear Amplifier).

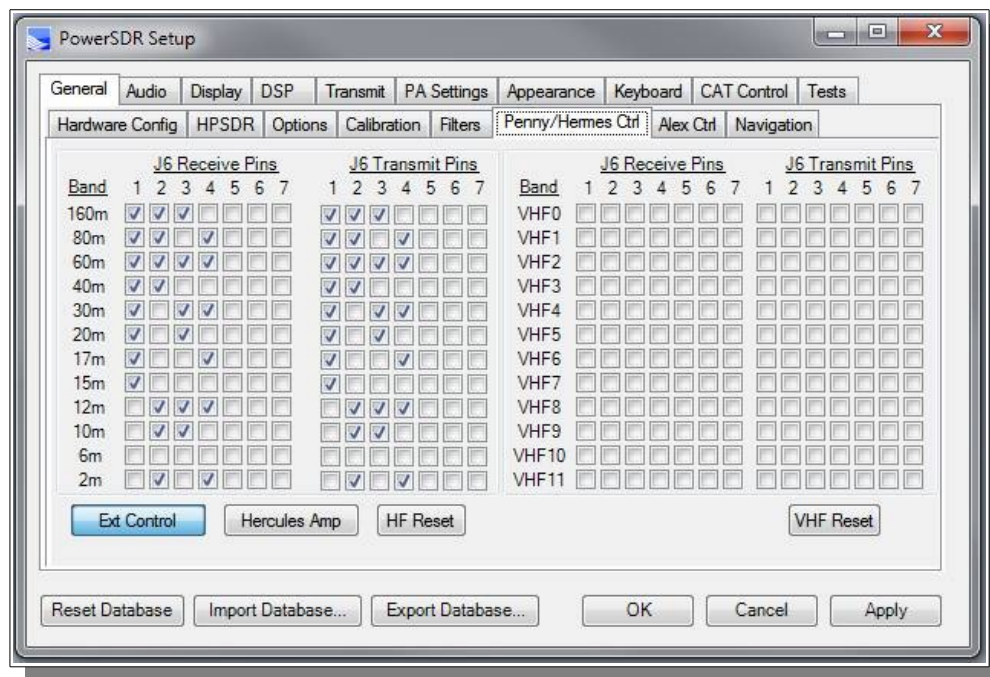

The utility "DDUTIL" may also prove useful and can be found here:
http://k5fr.com/ddutilwiki/index.php?title=Main_Page

Chapter 7 – How to use PureSignal Adaptive predistortion

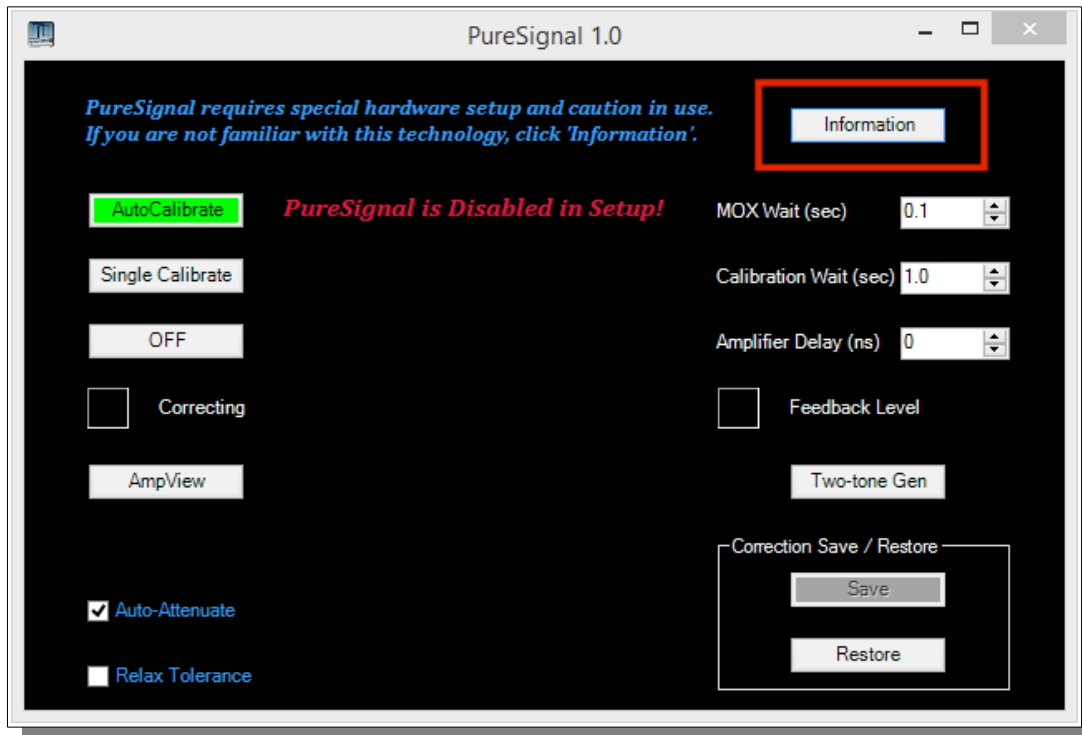

Information Tab of the **Linearization main menu** option.

Warren Pratt NRØV PureSignal Information

Linearity of an amplifier implies that the output increases linearly with increases of the input signal. i.e., if an input of 5W produces an output of 50W, then an input of 10W should produce an output of 100W.

Unfortunately, the analog amplifiers in our power amplifier stages are not so perfect. A real amplifier might behave more like the figure below.

The unfortunate side-effect of this NON-linearity is Inter-Modulation Distortion [IMD], some of which results in "splatter." Consequently, on the Panadapters of our SDRs it's easy to see signals that extend outside a normal transmit bandwidth. This phenomenon is more evident on strong signals as the IMD may be 25dB or more down from the peak of the signal. This IMD pollutes our bands and raises the interference and noise levels for amateurs that may be operating many kilohertz away from the offending transmitters. Some of the IMD is less visible on Panadapters because it falls IN-BAND, i.e., within the bandwidth of the transmitted signal. This adds distortion to the signal.

Fortunately, several techniques have been developed to improve the linearity of analog amplifiers and thereby reduce the IMD levels that they generate. One such method is "Predistortion"—making the amplifier's output more linear by "predistorting" the input signal in such a way as to offset the distortion that the amplifier will produce. The output of the amplifier can therefore be corrected to behave very much like the ideal case shown above.

Editorial note: IMD robs you of the value of an expensive Linear Amplifier by needlessly pumping out bad Energy in opposite sideband and IMD splatter.

How to Use PureSignal Adaptive Predistortion

When you have your Transceiver operating properly for SSB communication (Mic, Drive, PA, Filters, Profile) you are ready to improve your Tx signal quality.

- Select the Linearity tab at the top of the Main PowerSDR Window
- Select the **INFORMATION** link or button at the top of the PureSignal control window.

- If your PC is setup properly, PureSignal will automatically open a new Window displaying a detailed text and graphics pdf document Introduction and explanation by Warren Prat NRØV

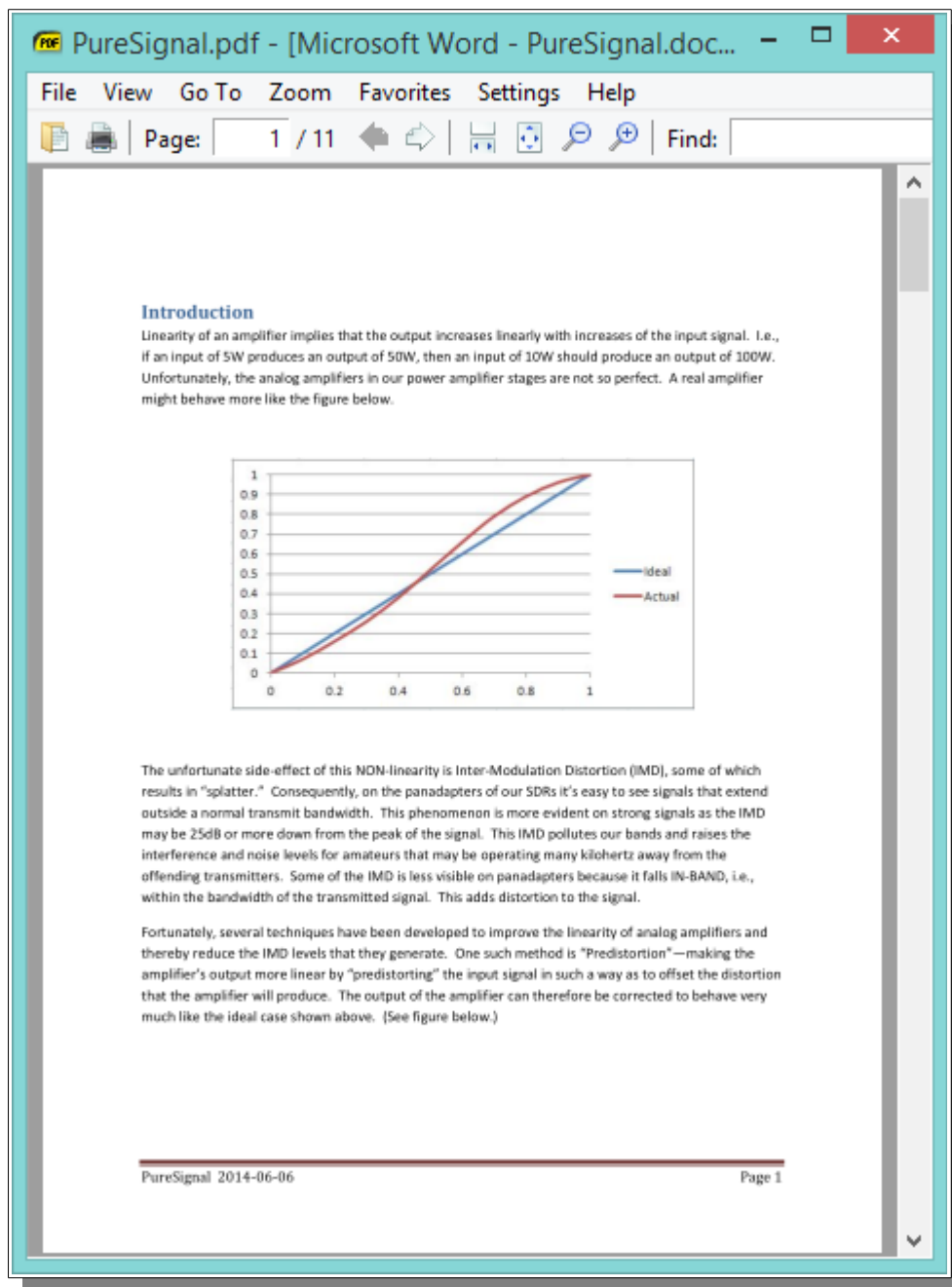

please take the time to read (and print out) this excellent document. You will have the best results and enjoy improved signal quality and performance by following Warren's instructions.

● In PowerSDR release **3.2.25** Warren has introduced a sophisticated new **“Automatic Tx Attenuation”** adjustment.

This was previously done manually by the operator using Setup ---> General ---> Ant/Filt and adjusting the thumb wheel value of ATT on TX (as shown below) while watching for a GREEN Feedback Level in the Linearization window indicating that you have sufficient feedback RF signal for PureSignal to measure, evaluate, and correct with Adaptive Distortion techniques in the DAC Tx signal.

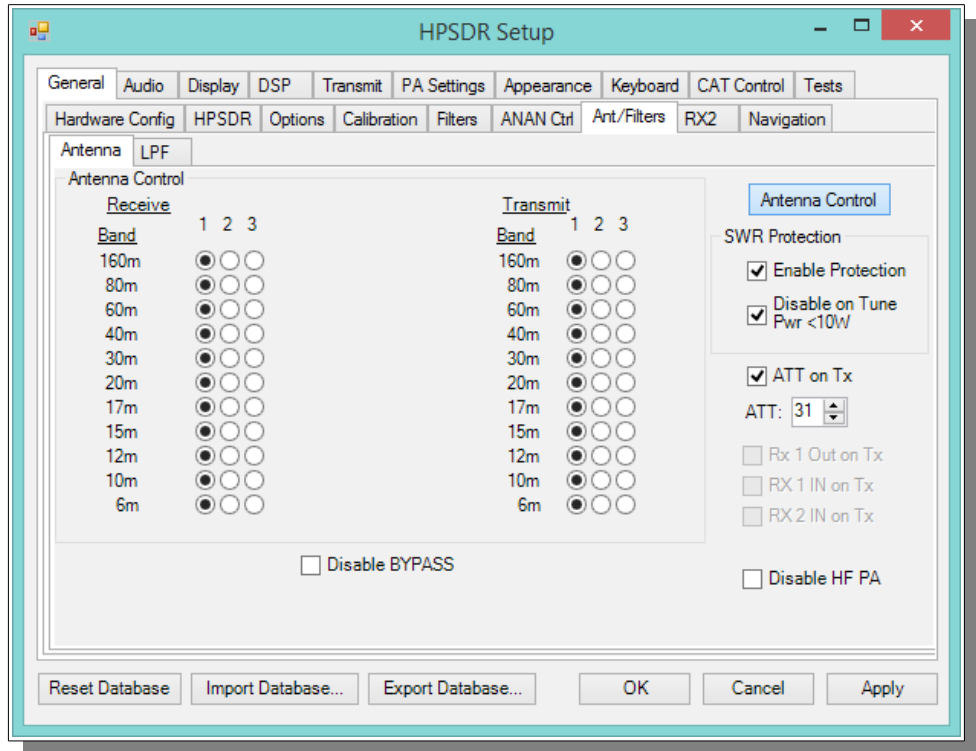

With the new automatic adjustment feature, Warren has dramatically improved PureSignal so that it is now even easier to use on a routine basis.

Using a DUMMY LOAD and your Panadapter set for DUF, you can activate the TWO TONE button in the PureSignal Window. You should immediately see your transmitted signal displayed with the primary and odd harmonic peaks. PureSignal will adjust your ATT on Tx for an optimal value and then in just a few seconds it will lower your 3rd, 5th, 7th harmonic peaks to a surprisingly lower level. PureSignal can optimally adjust unwanted IMD by as much as -45dbc. PureSignal will continue to optimize your signal as you speak in a normal voice.

Users who have a Linear Amplifiers properly equipped with an RF Signal Sampler will see a similar improvement in the quality of their transmitted two tone signal to the extent that PowerSDR can make mathematical adjustments for distortion introduced by the Linear Amplifier.

For more information about suitable couplers from the KC9XG Yahoo Group Files section:
<https://xa.yimg.com/df/KC9XG-SDR/PSSamplersCouplers.pdf>

Various directional coupler models are available

- ac2iqdave@gmail.com
- <http://www.elecraft.com>
- <http://www.wavenode.com>
- <http://www.cleanrf.com>

Chapter 8 – How to install a new version of PowerSDR software

Please refer to the Quick Start Software Installation information in Chapter 2

The most convenient method for updating is to download and install the latest PowerSDR .msi installation file from the OpenHPSDR Download webpage.

Updates to the PowerSDR software are issued by the volunteer Development Team on the OpenHPSDR Download webpage: <http://openhpsdr.org/download.php>

There have been a series of updates to add many new features and to improve performance. The current program is compiled with Microsoft® Visual Studio VS2010 and may be updated to VS2013 in the future. PowerSDR is written in "C" and "C#". The program is OpenSource.

Announcements about the latest version of PowerSDR are made via email on the Apache Labs Yahoo Group and the OpenHPSDR email list.

If you would like to test the latest update, you may wish to follow this safe procedure:

- BACKUP your current installation on a USB Flash Drive or DVD/CDROM so that you can restore your current operational preferences and settings in the even that you do not wish to continue with the latest version of PowerSDR.

Instructions to load independent versions on a single PC are summarized here:

- Go to the Properties of the shortcut.
- At the end of the Target you can add the new directory path using the command line argument `--datapath:<"directory path">`
- To create a new directory for the ANAN-10 radio I use the name PowerSDR ANAN_10 like this:
- `start --datapath:"%appdata%\FlexRadio Systems\PowerSDR ANAN_10\"`
- My new Target will look like this:
- `"C:\Program Files (x86)\OpenHPSDR\PowerSDR RX2 (W5WC)\PowerSDR.exe"
--datapath:"%appdata%\FlexRadio Systems\PowerSDR mRX\"`
- When you start PowerSDR using the modified shortcut you will receive this message the first time.
- Ensure the directory path is correct. The click on Yes.
- You will then get the normal startup with a new wisdom file and database created in the new folder.

- Each installation of PowerSDR makes entries in **BOTH** the `%appdata%` and Program Files (x86) folders. If you install a new version, it will override the XML DataBase that contains the detailed description of all your settings and preferences.
- at this time, there is no utility to retain your preferences and apply them to the next revision database

Chapter 9 - How/when to install a new version of Apache Firmware

New Firmware upgrades for all Apache Transceivers will be posted on the Apache Web site following acceptance testing by the Apache technical staff: <http://www.apache-labs.com>

HPSDRProgrammer and HPSDRBootloader

The **ANAN-10, ANAN-10, ANAN-100** use a **Hermes** Transceiver board and firmware.

The **ANAN-100D** uses the **ANGELIA** Transceiver board and firmware.

The **ANAN-200D** uses the **ORION** Transceiver board and firmware.

The ANAN-10 Transceivers were designed with an EEPROM to store the "bootloader" code in upper memory and the FPGA firmware .rbf file in lower memory. It is usually **not** necessary to reload the bootloader code.

Firmware updates are most easily uploaded into the EEPROM storage memory using the KVØS HPSDRProgrammer or HPSDRBootloader utilities. The most recent revision of these utilities is available on the OpenHPSDR Download webpage: <http://openhpsdr.org/download.php>

Firmware for the ANAN-10 is issued infrequently. Apache Labs installs the latest Firmware in each Transceiver at the Factory. The Firmware is stable and will operate smoothly without any maintenance required.

However, in the event that there is an update to add new features or improve performance, you should familiarize yourself with the documentation prepared by Phil VK6PH: http://svn.tapr.org/repos_sdr_hpsdr/trunk/Hermes/Documentation/Hermes_User_Manual_V1.18.pdf

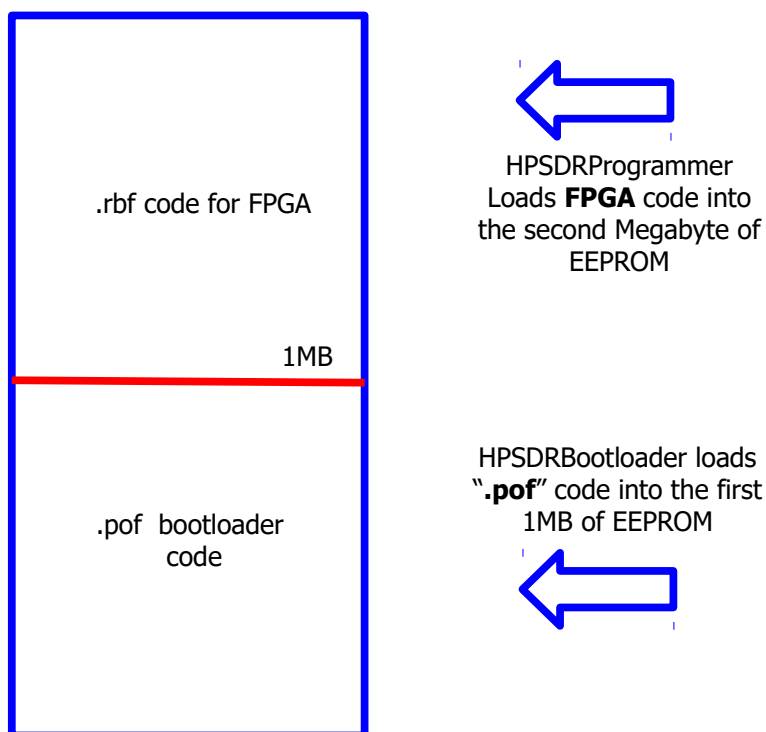



Pointers to reference materials

Apache Labs International Support

Technical support for ANAN-10 from the factory is available via the Apache Labs Yahoo Group

<http://groups.yahoo.com/group/apache-labs/>

or directly via email <support@apache-labs.com>

Apache Yahoo Support Group

<http://groups.yahoo.com/group/apache-labs/>

OpenHPSDR Group

Instructions relating to joining the OpenHPSDR Group reflector are here:

<http://lists.openhpsdr.org/listinfo.cgi/hpsdr-openhpsdr.org>

The OpenHPSDR archives may also be searched here:

<http://lists.openhpsdr.org/mmsearch.cgi/hpsdr-openhpsdr.org>

The latest version of the OpenHPSDR User Manual can be obtained from

<http://openhpsdr.org/documents.php> Revision 1.9 Author Phil Harman VK6PH

Apache Service and Repair

1023 Tower B4, Spaze I-Tech Park

Sector - 49, Sohna Road

Gurgaon - 122001

Haryana, India

Tel: 91-0124-4245173/4/5 (10AM - 6PM IST]

Email: support@apache-labs.com

Website: <http://www.apache-labs.com>

Apache Schematics

The current Apache ANAN-10 schematic can be downloaded from:

<https://apache-labs.com/al-downloads/1002/Hermes-Design-Files.html>



Warren Pratt NR0V PureSignal Information

Pointer to pdf documentation goes here

Original 2013 Users Guide

Please refer to the Technical Reference document (formerly User Guide v3.4] for information about various microphones and how to adapt them to the Apache Transceiver. You may find this reference helpful:

Website: <http://www.apache-labs.com>

Balanced Audio Input is not implemented in the current Apache Labs Transceivers.

The LEFT LINE level input is currently selectable in PowerSDR as an alternative to the mic input. Balanced audio is not supported by the Audio ADC hardware used in the ANAN radios. If a balanced input is required then an external balanced to unbalanced transformer (or active electronic equivalent] will be required.

Multiple independent .xml databases

Thank you **Doug W5WC** for this important information.

- Go to the Properties of the shortcut.
- At the end of the Target you can add the new directory path using the command line argument `-datapath:<"directory path">`
- To create a new directory for the ANAN-10 radio I use the name PowerSDR ANAN_10 like this:
- `start -datapath:"%appdata%\FlexRadio Systems\PowerSDR ANAN_10\"`
- My new Target will look like this:
- `"C:\Program Files (x86)\OpenHPSDR\PowerSDR RX2 (W5WC)\PowerSDR.exe"
-datapath:"%appdata%\FlexRadio Systems\PowerSDR mRX\"`
- When you start PowerSDR using the modified shortcut you will receive this message the first time.
- Ensure the directory path is correct. The click on Yes.
- You will then get the normal startup with a new wisdom file and database created in the new folder.

Bill KC9XG Audio IN/OUT diagram previously used here

Manual Calibration Procedure

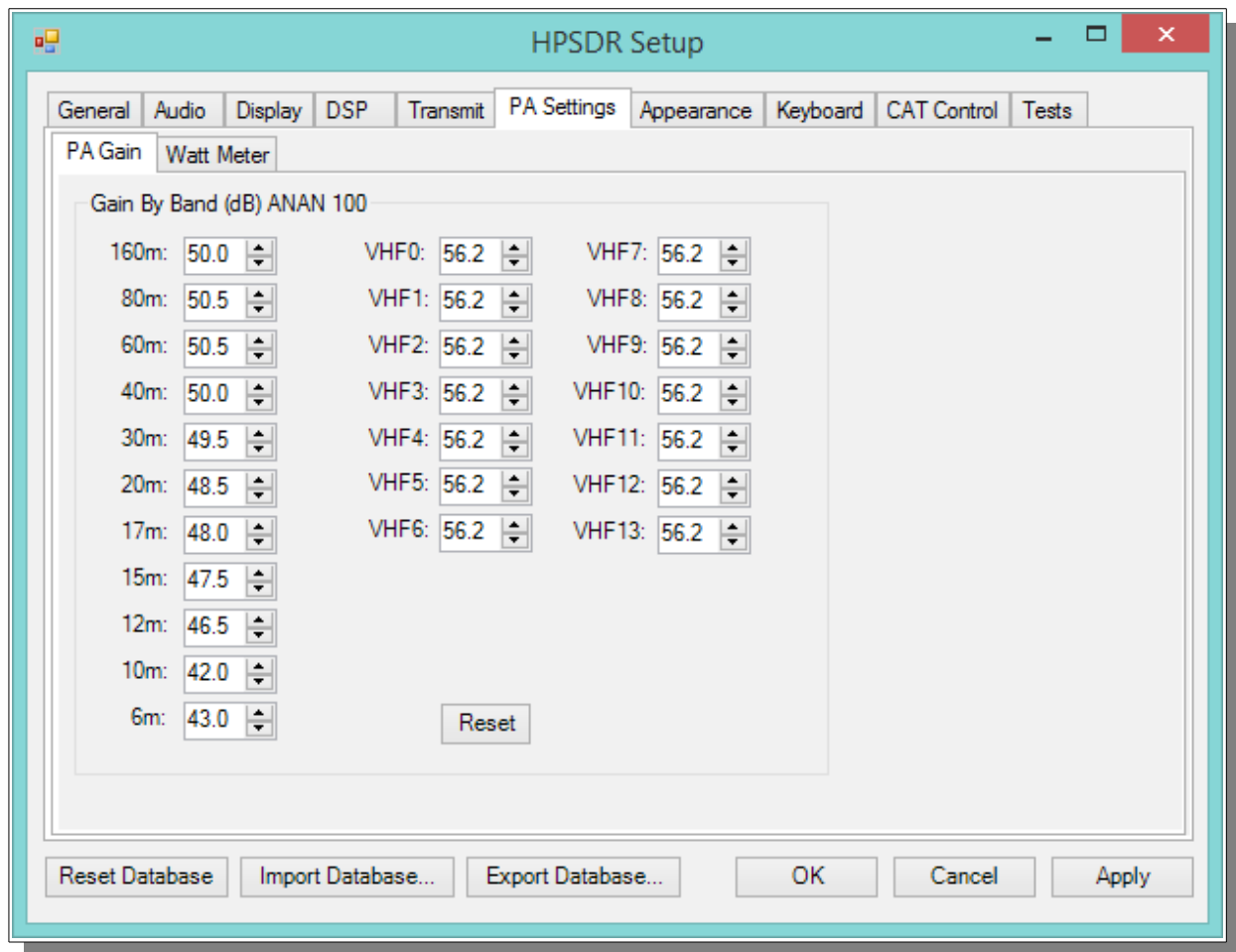

Use the following manual calibration procedure to properly set/calibrate your ANAN-10 power output into a dummy load:

1. Connect a suitable Dummy Load to ANT1 BNC port on the back panel of the Transceiver.
2. Click on menu selection, Setup, Transmit.
3. Set "TUNE", Power % to 100
4. Select "FWD Pwr" from the "TX Meter" upper right corner of the main OpenHPSDR/PowerSDR/OpenHPSDR window.
5. Enable the Antenna window by clicking on Setup ---> General ---> ANT/FILTERS tab to access the antenna settings.
6. Select the Transmit antenna ANT1 where you connected the Dummy Load.
7. Select the PA settings TAB on the Setup menu window.

The PA Settings TAB allows you to set (calibrate) the ANAN-10 Power Amplifier gain by band (dB – Power Output per Band] for each of the available Ham Bands. There is an up/down gain control for each band, which regulates the Power Amplifier output for that band. **As you increase the Gain By Band, power output will decrease. Conversely, decreasing Gain By Band will increase Power Amplifier output.**

Maximum power output per band can be reached at the lowest value in this menu.

8. Select one of the bands on the PA settings TAB.

9. Ensure you have the Setup ---> Transmit tab ---> Tune control set to 10 and a **Dummy Load** connected to the selected antenna port on the ANT/FILTERS setup tab.

10. Press "TUN" (Tune) on the upper left side of the OpenHPSDR/PowerSDR main display form on your computer.

11. Adjust the band gain value for a **MAXIMUM** TX Meter "FWD PWR" output reading of 10 watts while using your suitable Dummy Load. Do NOT use an Antenna for this calibration adjustment.

12. Press "TUN" button again to unkey the radio.

Repeat the above procedure for each Ham Band to properly calibrate the RF CW power output for a **MAXIMUM** 10 watts.

13. When all bands have been calibrated, remove the Dummy Load and select the antenna of your choice in the ANT/FILTERS setup Tab.

14. Remember to reduce the "TUN" power wattage setting on the Setup ---> Transmit tab to approximately 9W.



Computer Performance

Processing of streaming data in real-time can be a challenging task for Windows-based applications and device drivers. This is because by design Windows is not a real-time operating system. There is no guarantee that tasks can be executed in a deterministic (timely) manner.

Audio or video data streams transferred from or to an external device are typically handled by a kernel-mode device driver. Data processing in such device drivers is interrupt-driven.

Typically, the external hardware periodically issues interrupts to request the driver to transfer the next block of data. In Windows NT-based systems (Windows 2000 and later) there is a specific interrupt handling mechanism. When a device driver cannot process data immediately in its interrupt routine, it schedules a Deferred Procedure Call (DPC). Microsoft defines them as: A Deferred Procedure Call (DPC) is a queued call to a kernel mode function that will usually be executed at a later time. DPCs are used by drivers to schedule I/O operations that do not have to take place in an ISR at a high IRQL, and can instead be safely postponed until the processor IRQL has been lowered. When you look at Windows Task Manager and sort the running processes by CPU (Processor Utilization), the System Idle Process is almost always at the top of the list. What you may not know is that 'process' is really a roll-up of several things. Among other things included in that CPU number, is hardware interrupts and DPCs. You can see these two items by using the Microsoft "SysInternals" Process Explorer available here: [Process Explorer](http://www.sysinternals.com/ProcessExplorer.aspx)

The sycon's DPC Latency Checker is a free Windows tool that analyzes the capabilities of a computer system to handle real-time data streams properly. It may help you to determine if your personal computer is capable of powering your HPSDR system or to find the cause for interruptions in real-time audio and video streams, also known as 'drop-outs'. The program supports Windows 2000, Windows XP, Windows XP x64, Windows Server 2003, Windows Server 2003 x64, Windows Vista, Windows Vista x64, Windows 7 32 bit and 64 bit and is available here. Latency checker found by N9VV

<http://www.resplendence.com/latencymon>

and

http://www.thesycon.de/deu/latency_check.shtml



Warranty

We warrant that our products are free of defects in material and workmanship and extend this warranty under intended use and normal service conditions to the original owner for a period of one year from the date of purchase. This warranty does not apply to any product that has been repaired (Unauthorized] or altered in any manner and is void if damaged by accident, neglect, unreasonable use, improper installation, lack of proper impedance matching (High SWR], improper tuning, over driving power limits, damage due to use of any third party accessories, or any other cause not arising specifically out of defects in material or workmanship.

Our obligations are limited to repairing or replacing, at our sole discretion, any product or part that is returned to the mailing address, all shipping or transportation charges must be pre-paid, accompanied by proof of purchase and which examination reveals to have been defective within the warranty period stated above.

Our Warranty does not imply any obligation other than herein stated. Any implied warranties, including but not limited to fitness for a particular purpose, are limited in duration for the above one year period.

We shall not be liable under this warranty, or any implied warranty, for loss of use of the product or for any other consequential loss or damage incurred by the purchaser.

[Warranty -- Apache Labs website](http://www.apache-labs.com/terms-of-use.html) has a link to explain their warranty and other pertinent information: <http://www.apache-labs.com/terms-of-use.html> under "Terms of Use".

IMPORTANT

The FPGA and other components on the ANAN-10 PCBs can be damaged by Electrostatic Discharge (ESD]. When handling the PCB, you should take ESD precautions (e.g. use a work bench with an antistatic mat on it and wear a grounded wrist strap].

When powered on do not touch the top of any IC in order to determine its temperature. In particular, do not touch the Switch Mode Regulator IC. Touching its leads can change the switching frequency and alter the output voltage.

OpenHPSDR Software

OpenHPSDR/PowerSDR modifications

W5WC source code: click [here](#)

http://svn.tapr.org/repos_sdr_hpsdr/trunk/W5WC

W5WC skins with installer [here](#)

http://svn.tapr.org/repos_sdr_hpsdr/trunk/W5WC/OpenHPSDR_Skins/

K.I.S.S Konsole from OpenHPSDR team

http://svn.tapr.org/repos_hpsdr_kiss/branches/K9TRV/KISSKonsoleUnified

VK6PH has added new VNA capabilities to FPGA and K.I.S.S. codes.

ghpsdr3 - QtRadio from John Melton GØORX/N6LYT

and a new branch by Alex Lee

Heterodyne (MAC/OS] by Jeremy McDermond

OpenHPSDR software repository and information

<http://openhpsdr.org/download.php>



Contributing members to the Hermes project

THANK YOU each for the wonderful gift you have shared with us all

Kevin Wheatley M0KHZ who conceived the Hermes and is the Project Lead

Abhi Arunoday **Managing Director, Apache Labs**, PCB layout, manufacturer

Phil Harman - VK6PH - Software & hardware development, especially the brain wave for maintaining full DAC bits while reducing power.

Bill Tracey - KD5TFD - Component sourcing and kitting

Lyle Johnson - KK7P - significant contributor to hardware development

Scotty Cowling - WA2DFI – Parts procurement

Graham - KE9H - Hermes PA improvements

Doug W5WC for his adaptation of FLEX OpenHPSDR/PowerSDR to Hermes

Joe K5SO for his many software contributions.

George Brykit K9TRV for his installer and other software contributions.

Plus numerous other contributors via the OpenHPSDR reflector.

Apollo, a companion 20W PA, LPF and ATU, was conceived by Kjell Karlsen – LA2NI

The CORDIC Algorithm

The CORDIC mathematical algorithm used in the Apache-10W Transceiver;

CORDIC - Wikipedia, the free encyclopedia

<http://en.wikipedia.org/wiki/CORDIC>

CORDIC FAQ

<http://www.dspguru.com/dsp/faqs/cordic>

CORDIC FAQ-II

<http://www.dspguru.com/info/faqs/cordic2.htm>

CORDIC for Dummies

http://www.jacques-laporte.org/cordic_for_dummies.htm

The CORDIC Algorithm

<http://www.andraka.com/cordic.htm>

CORDIC

<http://www.nist.gov/dads/HTML/cordic.html>

From Hermes VHDL designer Phil Harman VK6PH:

The CORDIC takes the input samples and multiplies them by the sine and cosine of the phase value we feed to it (i.e. the frequency we want to tune to). The CORDIC is a successive approximation approach to generating the sine and cosine of an angle - since it only uses add and shift logic it was used in the early hand-held calculators. If we use enough bits in the CORDIC then the sine and cosine values it generates are so accurate that we get perfect I & Q signals out in terms of how well the amplitudes are matched and how close to 90 degrees apart they are.

As I said it is a successive approximation approach so it takes about 20 iterations to get the accuracy we need. In which case there is a delay of 20/122.88MHz from the time the RF appears at its input to the time the I and Q signals appear.

Because of this delay we use a technique called pipelining - we feed samples into a pipe that is 20 samples long and at the end of the pipe take the result out.

We decimate and filter at the same time. The [CIC](#) is a very simple way to produce a filter (just adds and subtracts] so it is very efficient to implement in the FPGA. But it's frequency response is not ideal so we follow it with a CFIR that compensates for the droop in the CIC passband and cleans up the overall shape.

The Hermes FPGA Verilog code can be found on the SVN <http://openhpsdr.org/download.php>

Accessory Port (back panel]

The Hermes/Angelia schematic detail J16 pin numbering does not correspond to keyed IDC ribbon cable numbering conventions.

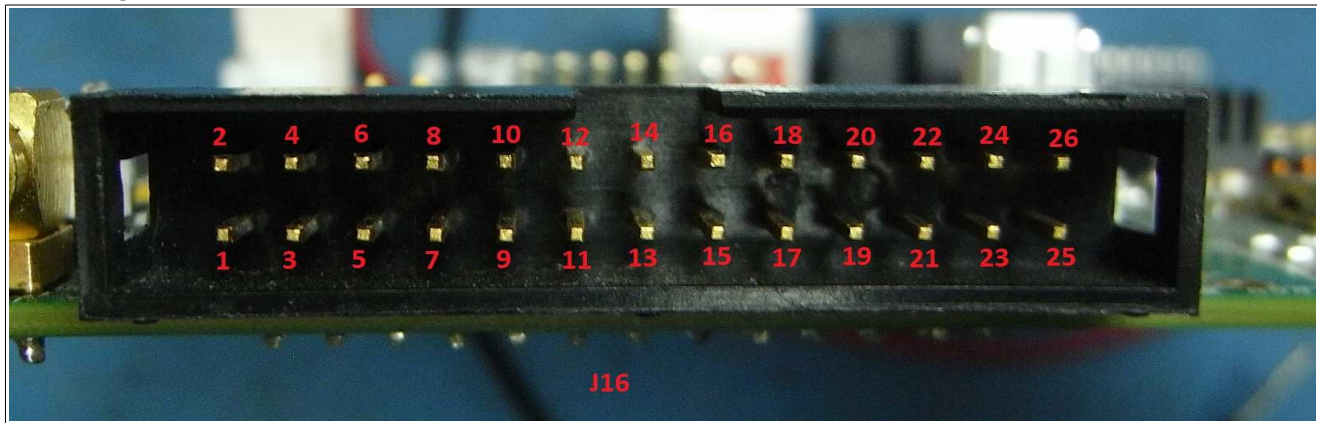

Pin out and connections between 26 pin J16, Modified [shifted] 26 pin IDC ribbon cable and DB 25.

J16 1 2 3 4 5 6 7 8 9 10 11 12 13 14 15 16 17 18 19 20 21 22 23 24 25 26
 IDC 26 25 24 23 22 21 20 19 18 17 16 15 14 13 12 11 10 9 8 7 6 5 4 3 2 1

NOTE: Left channel line audio input is the "Line In" source on the Setup, transmit tab. This input can be used instead of the mic jack. Pin 13 is PTT in.



NOTE: The speaker jack contains the Left Channel speaker pair. The Right Channel speaker pair is on pin 6 and Pin 19. These are balanced outputs. Do NOT ground these lines!

The OpenHPSDR/PowerSDR Setup, ANAN Ctrl tab numbering scheme for the J16 Receive and transmit pins does not represent the actual pin numbers.

acc Port pinout.	name	schematic pin numbers
1	Open-drain PTT output 25vdc @ 800ma	25
2	OC6 User open-collector output 7	23
3	OC4 User open-collector output 5	21
4	OC2 User open-collector output 3	19
5	OC0 User open-collector output 1	17
6	Right channel speaker Pair with pin 19	15
7	User Digital input 4: connected to 3.3V via 1K pullup resistor	13
8	User Analog input 1: 0-3V max	11
9	User Digital input 1: Connected to 3.3V via 1K pullup resistor	9
10	Left channel line Out	7
11	Right channel phones output	5

acc Port pinout.	name	schematic pin numbers
12	Left channel line-level audio input*	3
13	PTT input, connected to 3.3V via 1K pullup resistor	1
14	OCREF Open-Collector reference/flyback diodes	24
15	OC5 User open-collector output 6	22
16	OC3 User open-collector output 4	20
17	OC1 User open-collector output 2	18
18	User Digital input 2: Connected to 3.3V via 1K pullup resistor	16
19	Right channel speaker, pair with pin 6	14
20	User Analog input 2: 0-3V max	12
21	Analog Ground	10
22	Right channel line Out	8
23	Left channel phones output	6
24	not implemented	not implemented
25	Analog Ground	2

MARS operation

In PowerSDR select Settings → General → Hardware Config → **Region** you will be able to select band limits by country or Region. **Do not select "Extended"** unless your intended frequency of operation has been explicitly approved for your station operation on the intended frequency.

APIPA Automatic Private IP Addressing

Definition: A feature of Microsoft Windows, **APIPA** is a [DHCP](#) failover mechanism for local networks. With APIPA, DHCP clients can obtain IP addresses when DHCP servers are non-functional. APIPA exists in all modern versions of Windows except Windows NT.

When a DHCP server fails, APIPA allocates IP addresses in the private range 169.254.0.1 to 169.254.255.254. Clients verify their address is unique on the network using [ARP](#). When the DHCP server is again able to service requests, clients update their addresses automatically.

In APIPA, all devices use the default network mask 255.255.0.0 and all reside on the same [subnet](#).

APIPA is enabled on all DHCP clients in Windows unless the computer's Registry is modified to disable it. APIPA can be enabled on individual network adapters.

Also Known As: Automatic Private IP Addressing; AutoNet

Examples:

Because APIPA uses IP addresses in the private Class B space, APIPA is a feature generally only useful on home or other small intranet LANs.

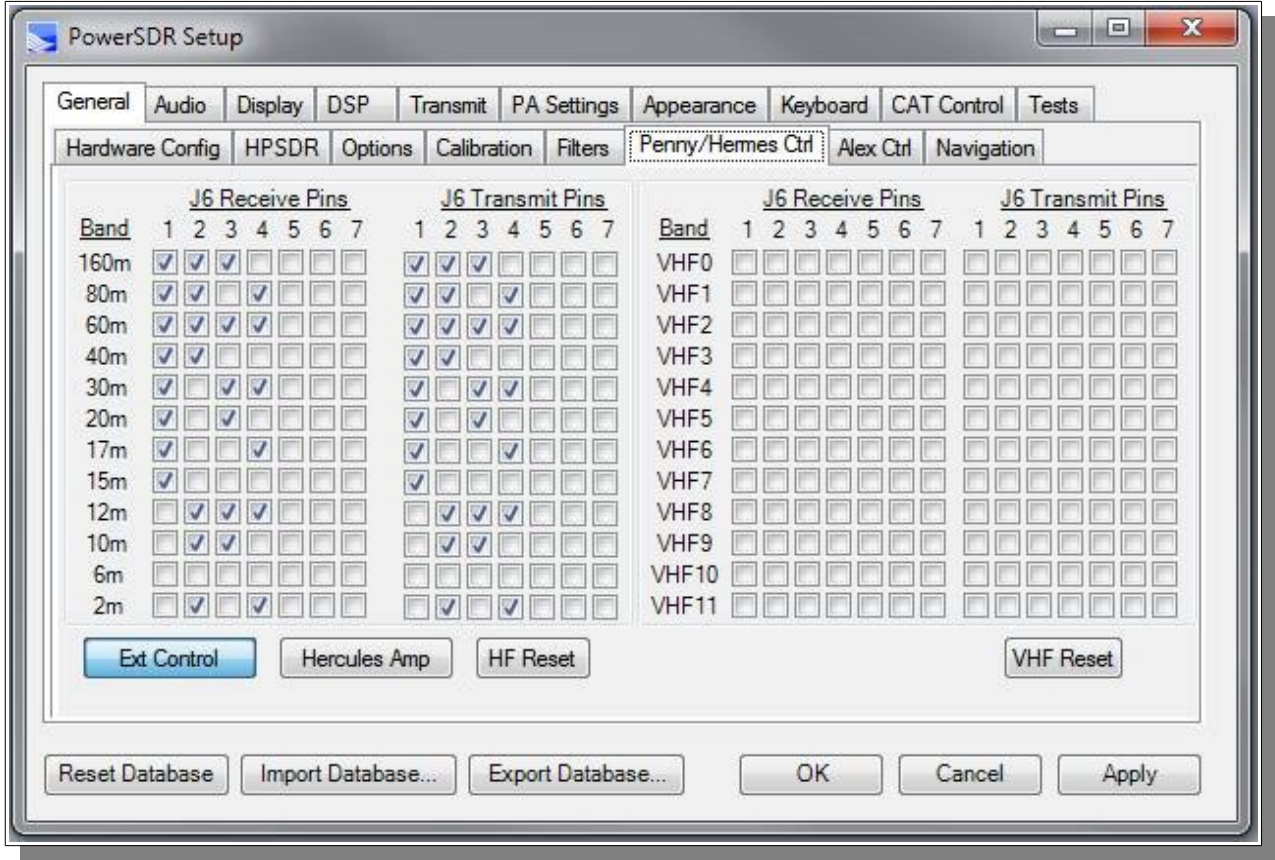

Apache Labs ANAN-10/100 (Hermes) PCB

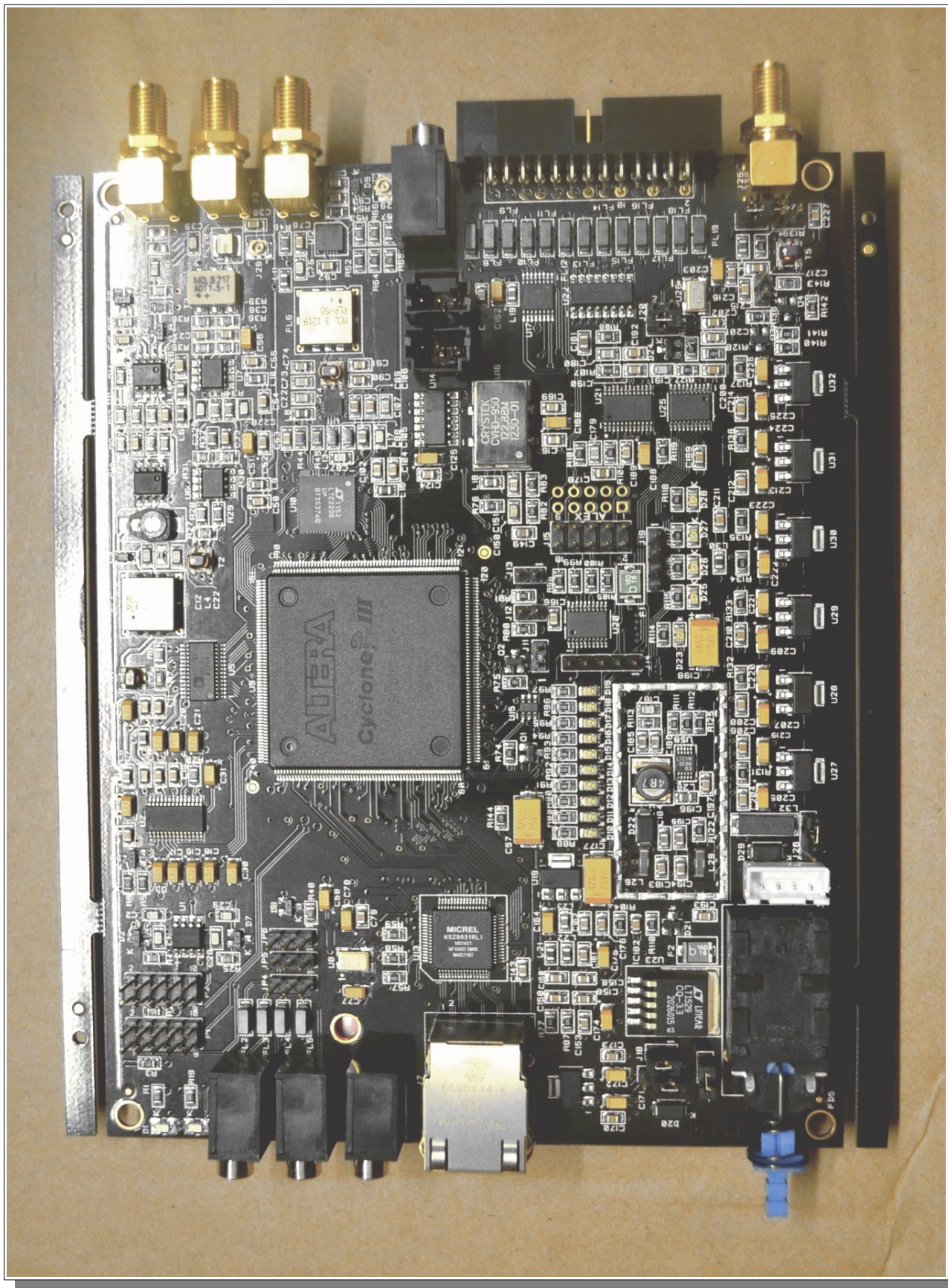

ANAN-10 jumper locations

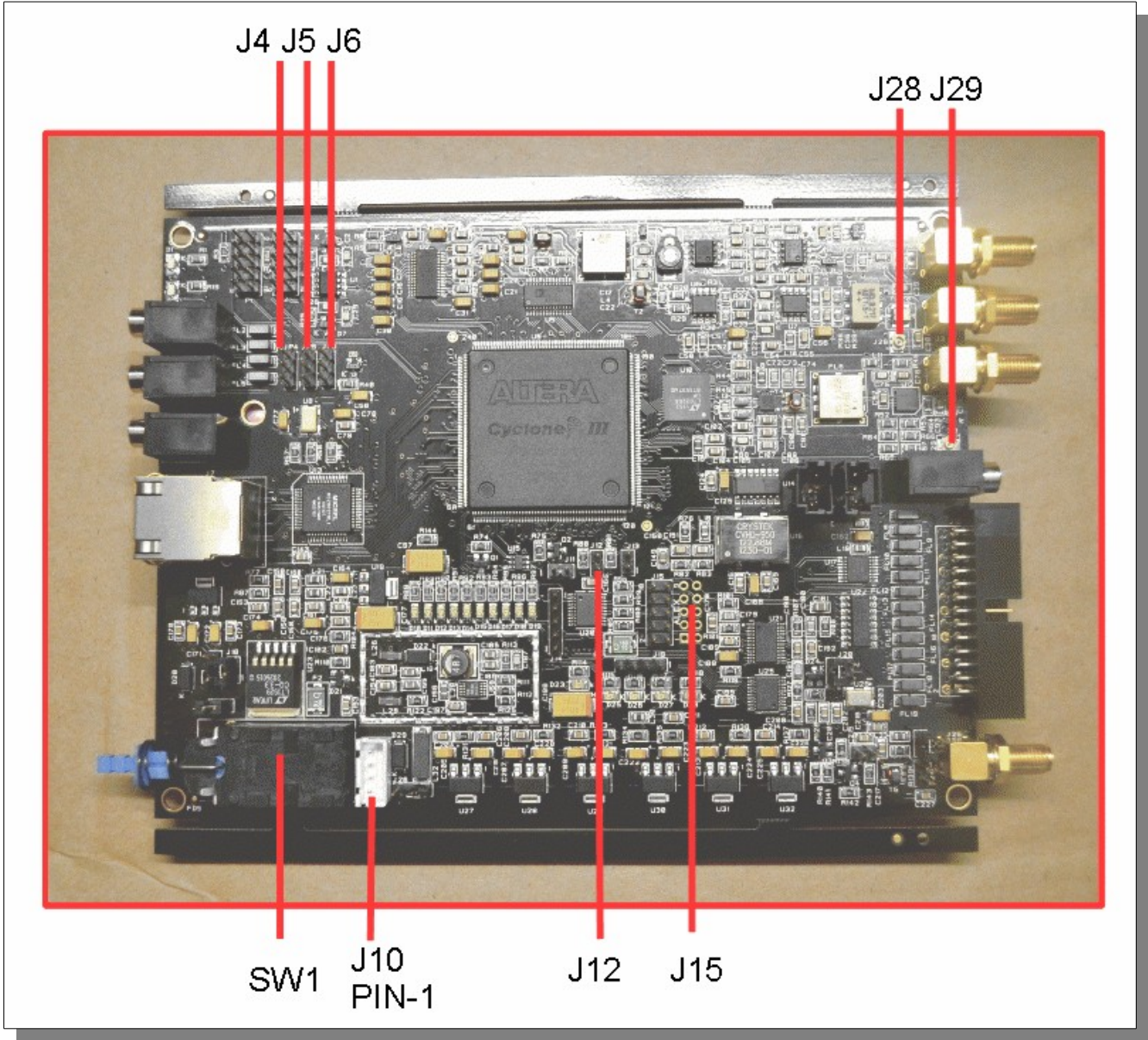

Apache Labs ANAN-10/100 Block Diagram (courtesy VK6PH)

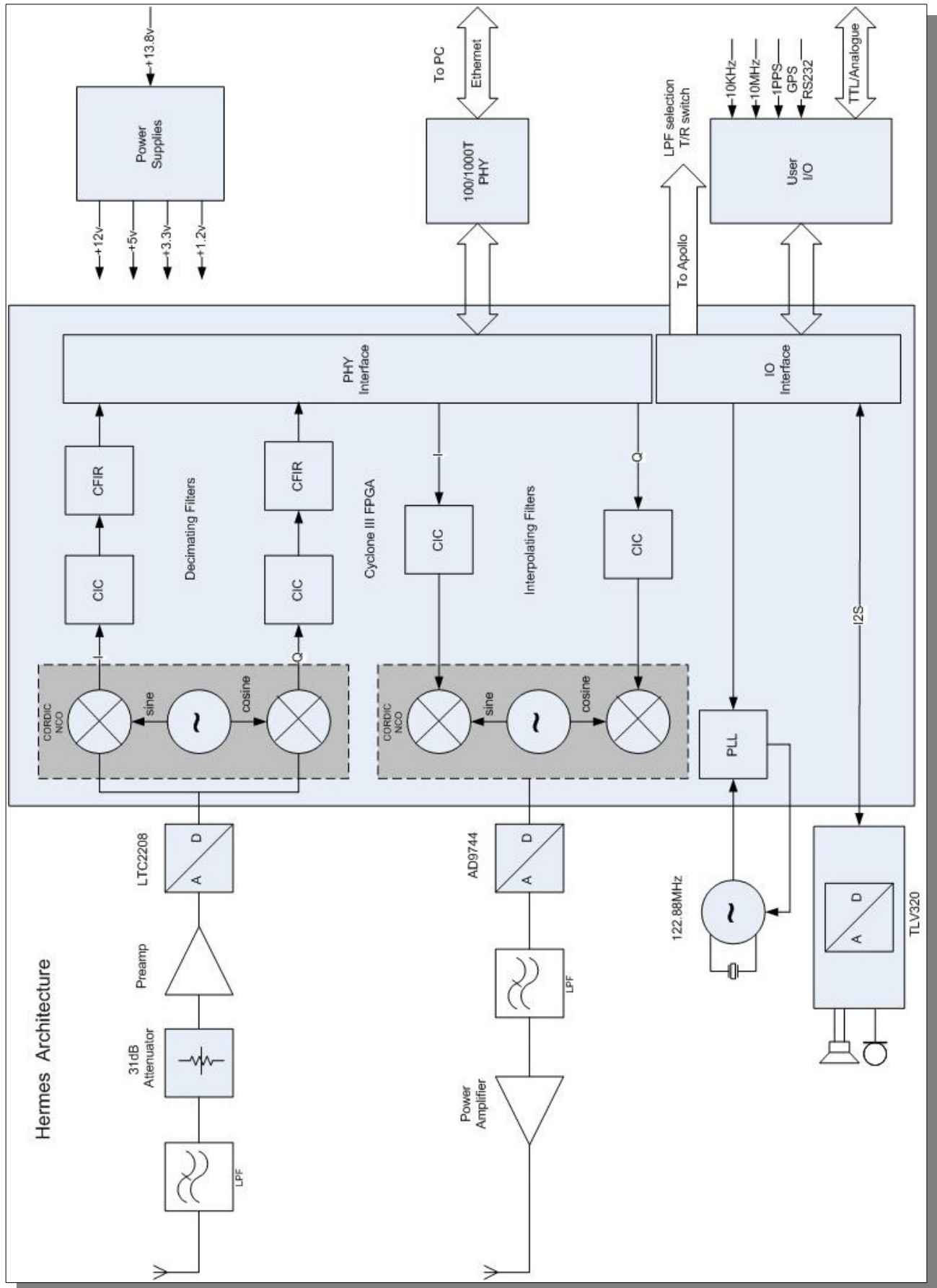



NOTES

Alphabetical Index

13.8vdc minimum, 7A.....	11
25vdc.....	39
800ma.....	39
Abhi Arunoday.....	52
Accessory Port (back panel].....	54
Adjusting mic gain.....	24
ALC.....	23
ALC.....	39
ANAN back panel.....	13
ANAN Front Panel.....	12
ANAN Hardware Requirements.....	11
ANAN-10 Linear Amplifier PTT OUT.....	39
Android.....	11
Antenna Connections.....	21
Antenna Control menu.....	28
Apache Labs ANAN-10/100 (Hermes] PCB.....	58
Apache Labs International Support.....	46
Apache Schematics.....	46
Apache Service and Repair.....	46
Apache Yahoo Support Group.....	46
Apollo.....	52
appdata.....	44
Audio Chain - How it works.....	23
BACKUP.....	44
Bill Tracey - KD5TFD.....	52
Break-in Delay.....	33
CCS (Continuous Commercial Service] 3W.....	8, 29
CE and RTTE Certified.....	7
CFIR.....	53
Chapter 1 - Introduction.....	9
Chapter 2 - Quick Start Instructions.....	14
Chapter 3 – How to operate SSB Phone.....	22
Chapter 4 – How to operate Digital modes.....	29
Chapter 5 – How to operate CW.....	30
Chapter 6 – How to Interface to your Linear Amplifier.....	39
Chapter 7 – How to use PureSignal Adaptive predistortion.....	41
Chapter 8 – How to install a new version of PowerSDR software.....	44
Chapter 9 - How/when to install a new version of Apache Firmware.....	45
CIC.....	53

Clarification CCS (3W]/ICAS (10W].....	8, 29
COMPRESSOR.....	23
Computer Performance.....	49
Computer with Full Duplex Ethernet NIC card.....	9
Connect a good antenna.....	34
Connecting a suitable Microphone.....	22
Contributing members to the Hermes project.....	52
CORDIC.....	53
CTUNE.....	36
cudaSDR.....	11
cuSDR.....	11
CW DELAY setting of 300ms.....	33
CW key terminated in 3.5mm.....	11
CWU/CWL.....	31
Damage to the radio caused in this manner is not covered by Warranty.....	39
DC Ammeter.....	39
DC Voltmeter.....	39
Declarations of Conformity.....	7
Direct numeric input.....	35
direct-down-conversion (DDC] receiver.....	9
direct-up-conversion (DUC] transmitter.....	9
Do not expect fast QSK.....	33
Doug W5WC.....	52
DOWNWARD EXPANDER.....	23
Drag Mouse.....	36
DUP.....	36
Dxzone Software Catalog.....	29
FILTER.....	23
Full Duplex Ethernet switch.....	9
ghpsdr3.....	11
Graham - KE9H.....	52
GRAPHIC EQUALIZER.....	23
Hardware Setup.....	14
Heat Dissipation.....	8
Heterodyn.....	11
How to test your PTT Linear Amplifier.....	39
HPF/LPF Filters and switching in ANAN Transceiver.....	27
HPSDRBootloader.....	45
HPSDRProgrammer.....	45
http://www.apache-labs.com	45
HUBS will NOT work.....	9

Iambic A/B.....	30
ICAS modes (Intermittent Commercial/Amateur Service] 10W PEP.....	8, 29
Important.....	39
Inter-Modulation Distortion.....	41
Introduction.....	9
Java.....	11
Joe K5SO.....	52
John Melton GØORX/N6LYT.....	11
Kevin Wheatley M0KHZ.....	52
Keyboard commands.....	35
KISS Konsole.....	11
Kjell Karlsen – LA2NI.....	52
LEVELER.....	23
Linearity of an amplifier.....	41
LOCK VFO.....	36
Lyle Johnson - KK7P.....	52
manual calibration procedure.....	48
Methods for tuning your Transceiver.....	35
Methods for tuning your Transceiver to a frequency.....	35
Methods for tuning your Transceiver to a frequency - continued.....	36
MIC Adapters.....	22
MIC GAIN.....	23
microphone terminated in 3.5mm.....	11
Microsoft .NET 4.x Framework.....	15
Minimum Requirements.....	9
NON-linearity.....	41
OpenHPSDR.....	45
OpenHPSDR Group.....	46
OpenHPSDR Software.....	51
openhpsdrJ.....	11
Operation tips.....	8
Original 2013 Users Guide.....	47
Paddle Connection.....	31
Panadapter set for DUP.....	43
Phil Harman - VK6PH.....	52
pin 1 of the AUX I/O Ribbon connector.....	39
pipelining.....	53
Plug.....	31
Point and Click with Mouse.....	35
Pointers to reference materials.....	46
posted on the Apache Web site.....	45

PowerSDR.....	11
Program Files (x86).....	44
PTT input.....	39
PureSignal.....	41
PureSignal control window.....	41
QSK.....	33
Region.....	56
release 3.2.25 Warren has introduced a sophisticated new "Automatic Tx Attenuation" adjustment.....	43
Roll Mouse Wheel.....	36
Sample Rate.....	30
Scotty Cowling - WA2DFI.....	52
Select Operating Frequency.....	32
Select the INFORMATION link.....	41
Select the Linearity tab.....	41
select your operating frequency.....	32
Selecting Transmit Profile.....	24
Set Drive Level.....	32
Set the DRIVE LEVEL.....	32
Setting up PowerSDR for Phone Operation.....	24
Sidetone Level.....	34
Software and download information.....	11
Software Setup.....	15
suitable couplers.....	39, 43
The CORDIC Algorithm.....	53
Transmit Filter.....	26
Transmitting.....	26
Tune.....	26
TUNE button to see your SWR and OUTPUT.....	37
Tuning.....	35
TWO TONE button.....	43
Updates to the PowerSDR software.....	44
Various directional coupler models are available.....	39p., 43
VB-Audio.....	22
Virtual Audio Cable.....	22
VK6PH.....	53
VK6PH example OpenCOllector BCD keying.....	40
VOX.....	26
VSP, Com0Com, RigCAT, Omni-Rig, VAC, VB-Audio.....	29
W1HKJ Fldigi.....	29
Warranty.....	50

Warren Prat NRØV.....	42
Warren Pratt NRØV PureSignal Information.....	47
Warren Pratt NRØV PureSignal.....	41
Windows Installation.....	15
XML DataBase.....	44
.....	9, 15, 23, 46p., 49, 51
Linear Amplifiers properly equipped with an RF Signal Sampler.....	43
%appdata%.....	44

