



HF/VHF/UHF  
Full mode SDR transceiver  
Ailunce HS2  
User manual  
(FW V1.2.2)

# Directory

<a href="#">Summary .....</a>	<a href="#">2</a>	<a href="#">LoRa/Compass.....</a>	<a href="#">20</a>
<a href="#">Accessories and options .....</a>	<a href="#">4</a>	<a href="#">Music .....</a>	<a href="#">20</a>
<a href="#">Specifications .....</a>	<a href="#">5</a>	<a href="#">Set.....</a>	<a href="#">20</a>
<a href="#">Panel control and operation .....</a>	<a href="#">8</a>	<a href="#">Rear panel interface .....</a>	<a href="#">21</a>
<a href="#">Front panel .....</a>	<a href="#">8</a>	<a href="#">Interface definition .....</a>	<a href="#">23</a>
<a href="#">Key Function .....</a>	<a href="#">9</a>	<a href="#">Transmitting operation.....</a>	<a href="#">24</a>
<a href="#">Indicator light .....</a>	<a href="#">10</a>	<a href="#">SSB communication .....</a>	<a href="#">26</a>
<a href="#">Main interface .....</a>	<a href="#">11</a>	<a href="#">CW communication .....</a>	<a href="#">26</a>
<a href="#">Band selection operation .....</a>	<a href="#">12</a>	<a href="#">FM communication .....</a>	<a href="#">27</a>
<a href="#">Different frequency operation .....</a>	<a href="#">12</a>	<a href="#">Relay operation .....</a>	<a href="#">27</a>
<a href="#">AF audio setting .....</a>	<a href="#">13</a>	<a href="#">AM communication .....</a>	<a href="#">28</a>
<a href="#">RF setting .....</a>	<a href="#">13</a>	<a href="#">Data communication RTTY .....</a>	<a href="#">28</a>
<a href="#">USB sound card data output format setting .....</a>	<a href="#">14</a>	<a href="#">Customize digital pattern mode .....</a>	<a href="#">28</a>
<a href="#">Transceiver frequency offset setting .....</a>	<a href="#">14</a>	<a href="#">CAT control .....</a>	<a href="#">29</a>
<a href="#">Transceiver mode setting .....</a>	<a href="#">15</a>	<a href="#">Computer third-party software setting operation .....</a>	<a href="#">30</a>
<a href="#">Tune operation .....</a>	<a href="#">15</a>	<a href="#">JTDX setting .....</a>	<a href="#">30</a>
<a href="#">A/B frequency operation .....</a>	<a href="#">16</a>	<a href="#">HRD setting .....</a>	<a href="#">32</a>
<a href="#">NR/NB noise suppression setting .....</a>	<a href="#">16</a>	<a href="#">N1mm setting .....</a>	<a href="#">34</a>
<a href="#">Spectrum and waterfall display setting .....</a>	<a href="#">17</a>	<a href="#">HDSDR setting .....</a>	<a href="#">35</a>
<a href="#">Spectrum parameter display setting .....</a>	<a href="#">17</a>	<a href="#">Mobile APP .....</a>	<a href="#">38</a>
<a href="#">Digital filter operation .....</a>	<a href="#">18</a>	<a href="#">PC software .....</a>	<a href="#">38</a>
<a href="#">Transmitting power setting .....</a>	<a href="#">18</a>	<a href="#">Receiving advanced operation .....</a>	<a href="#">38</a>
<a href="#">Application menu operation .....</a>	<a href="#">18</a>	<a href="#">HS2 firmware upgrade .....</a>	<a href="#">40</a>
<a href="#">FM Broadcast .....</a>	<a href="#">19</a>	<a href="#">Warnings .....</a>	<a href="#">41</a>
<a href="#">Bluetooth/GPS.....</a>	<a href="#">19</a>	<a href="#">Product warranty card.....</a>	<a href="#">49</a>

# Summary

HS2 is an ultra-portable full-frequency full-mode SDR radio which is launched by us. The receiving frequency is 300kHz ~ 1.6GHz, and the transmitting band covers 160m ~ 70cm.

HS2 operation modes include SSB, CW, AM, FM, LoRa, and digital modes. It includes all the advanced functions and features of all radio stations.

HS2 is designed with two power supply modes, USB interface, and the DC interface. The power supply voltage range is a 5VDC ~ 32VDC. At the same time, all power interfaces support anti-reverse connection protection.

The display adopts high brightness and high-resolution liquid crystal display, the backlight brightness can be adjusted, and it can also be clearly displayed outdoors. The panel is designed with a full keyboard, which is convenient for various operations. The keyboard backlight can be adjusted to operate the radio in a dark environment.

The built-in network interface can realize remote operation and remote firmware upgrade<sup>\*1</sup>. The HAM-BOX mobile APP developed by Retevis company can remotely control the radio<sup>\*2</sup>, making radio operation more convenient and fast. It has a built-in Bluetooth module, a USB cable integrated sound card, and a serial port, and a USB cable can control the radio.

HS2 has a lot of advanced features that are only available in large base stations. This machine has dual VFO mode, different frequency operation function, intermediate frequency offset adjustment, receiving frequency fine-tuning, intermediate frequency noise suppression, AGC speed selection, RF gain adjustment, squelch control, front attenuator, AM aviation communication reception, AM/FM Broadcast reception, built-in telegraph automatic key, automatic key-point ratio adjustment, built-in CTCSS analog tone, automatic shutdown function (APO), transmission timeout function (TOT); connection with computer and computer-aided control function, copy function, etc.

In addition, HS2 has a wide range of options.

---

\*1: Reserved function, Pay to use, still in developing, temporarily unavailable, we will release it when it is available.

\*2: Reserved function, still in developing, temporarily unavailable, we will release it when it is available.

## HS2 Basic Features and Application

### Feature

- 1, Real-time spectrum
- 2, Waterfall illustration
- 3, Doppler frequency tracking(under development)
- 4, Software Defined Radio (SDR) technology, the full frequency band supports SSB, CW, RTTY, AM, FM.
- 5, Double frequency conversion circuit structure
- 6, The Intermediate Frequency width and Intermediate Frequency displacement hardware and software can be modified to provide powerful IF interference suppression
- 7, DSP digital noise reduction
- 8, Built-in (6 ~ 160) m high-speed automatic Antenna tuner
- 9, Built-in electronic key controller, all parameters can be flexibly set.
- 10, Built-in sound card with IQ and audio output
- 11, Internal memory
- 12, USB Type-C 3.1 interfaces for power supply and computer connection.

- 13, High precision TXCO  $\pm 0.5\text{ppm}$  (- 10 °C ~ 60 °C)
- 14, Ultra-wide working voltage range: 5VDC ~ 32VDC\*<sup>1</sup>
- 15, Power supply reverse connection protection
- 16, Built-in GPS/ BeiDou Navigation Satellite System, GSM, electronic compass (acceleration, angle sensor) (optional)
- 17, GPS timing (requires optional GPS module)
- 18, Built-in UTC clock
- 19, Voltage display
- 20, Unique LoRa data transmission (requires matching LoRa module).
- 21, Ultra-lightweight:  $\leq 2\text{kg}$
- 22, Built-in remote operation network interface, remote firmware upgrade\*<sup>2</sup>

### Application

Emergency communication, Remote spectrum monitoring and sensing  
Radio direction finding, Ham radio

\*<sup>1</sup>: 5—32V receiving range, 5-12V transmit power limit, 12-15v UV full power output, 12-18V HF full power output, 15/18-32V prohibits transmit.

\*<sup>2</sup>: Reserved function, still in developing, temporarily unavailable, we will release it when it is available.

## Accessories and options

Standard	Option
FM Module	GPS Module
Bluetooth Module	LoRa Module
Built-in Sound Card	Electronic Compass Module (Altimeter)
Built-in Automatic Tuner	Shortwave Balcony Antenna
Internal Memory	External VFO Knob
DC Power Cord	Bluetooth Hand Microphone
Type-C USB Cable	
Wired Hand Microphone	

## Specifications

Transmitter Parameter	
Transmitting Architecture	SDR
Transmitting Mode	SSB, CW, RTTY, AM, FM
Frequency Resolution	1Hz
Transmitting Frequency Range <sup>*1</sup> /MHz	1.800~2.000; 3.500~3.900; 5.351.5~5.366.5; 7.000~7.200; 10.100~10.150; 14.000~14.350; 18.068~18.168; 21~21.450; 24.890~24.990; 28~29.7; 50~54; 144~146; 430~440.
Output Power <sup>*2</sup>	HF+6m: SSB: 1W~20W, CW: 0.1W~20W, FM: 0.1W~20W, AM: 1W~5W; VHF: SSB/CW/FM: 0.5W~5W; UHF:SSB/CW/FM: 0.5W~5W.
Power Consumption	TX: 13.8V*6A(20W); RX: 13.8V*0.35A Typical value, 0.45A(Maximum brightness, audio peak)
Carrier Suppression	<50dB
Spurious Suppression	1.8 MHz~54MHz: ≥50dB; 144 MHz~146MHz: ≥60dB; 430 MHz~440MHz: ≥60dB.
Number of Channels	999 (Temporarily unavailable)

Receiver Parameter	
Receiving Architecture	SDR
Receiving Mode	SSB,CW,RTTY,AM,FM
Receiving Frequency Range	300kHz~1.6GHz*
Intermediate Frequency Bandwidth	20kHz
Intermediate Frequency	ZERO IF
Sensitivity*2	SSB/CW:(BW: 2.4kHz @ 10dB S/N) ; 0.18μV(1.8~54)MHz; 0.25μV(144~146)MHz; 0.25μV(430~440)MHz; AM:( BW: 6kHz @ 10dB S/N); 15μV(0.3~1.8)MHz; 2μV(1.8~54)MHz; 2μV(144~146)MHz; 2μV(430~440)MHz; FM:(BW: 15kHz @12dB S/N); 0.5μV(28.0~29.7)MHz; 0.25μV(50~54)MHz; 0.3μV(144~500)MHz; 0.5μV(430~440)MHz.
Intermediate Frequency suppression	≥70dB
Image Suppression	≥80dB
Audio Output Power	2W(10% distortion rate, 4Ω load, 3kHz)
Spectrum Parameter	
Spectrum Bandwidth	48K
Radio Frequency Spectrum	FFT

<b>Antenna Tuner Parameter</b>	
Tuning Frequency Range	1.8 MHz~54MHz
Tuning Impedance Range	16.7Ω~150Ω unbalance (standing wave ratio is better than 1:3)
Tuning Accuracy	VSWR: ≤1:1.5or less
Tuning Time	2s~5s (Full Band 10s)
Tuning Ways	Automatic/Manual
<b>Structural Parameter</b>	
Size	190mm×120mm×45mm (without protrusions)
Weight	<1.5kg
<b>Working Voltage Parameter</b>	
Voltage Range	Receiving range is 5V ~ 32V, transmitting power limit is 5V ~ 12V, full power output is 12V~18V, transmitting power limit is 18V~32V.
<b>Antenna Interface</b>	
Antenna Interface	M
<b>Working Environment Parameter</b>	
Working Temperature	-10℃ ~ 60℃
Working Humidity	10%~70%

**Note:**

\*1: The frequency is set according to local laws.

\*2: To be calibrated, the final interpretation right belongs to the manufacturer.



# Panel control and operation

## Front panel

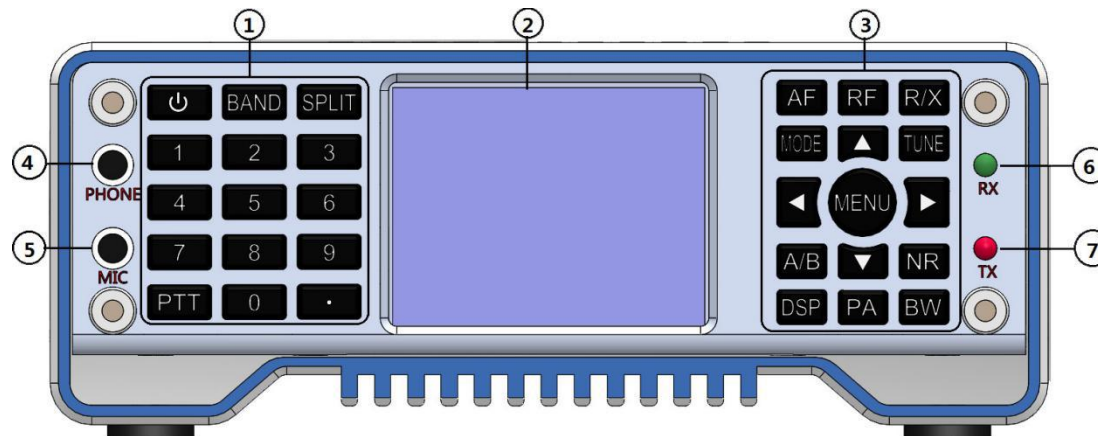

- ① Numeric keyboard
- ② LCD Monitor
- ③ Function keyboard
- ④ Headphone interface
- ⑤ Wired hand microphone interface
- ⑥ Receiving indicator
- ⑦ Transmitting indicator

## Key Function

Key	Short key Function	Long Key Function
Power	Switch the standing wave table (VSWR), ALC, MIC audio indication	Power on, power off
Band	Frequency band selection	CW setting
Split	Different frequency on, different frequency off	CTCSS setting
AF	Volume, MIC gain, MIC audio compression, ground bass, treble	*
RF	Radio frequency gain, Intermediate frequency gain, AGC, SQL, AMP	USB data output format selection
R/X	RIT receiving frequency offset, XIT transmitting frequency offset	Transceiver frequency deviation switch
Mode	Mode setting	USB/LSB, NFM/WFM/CWR switching
Tune	Antenna tuner on and off	Antenna tuner start and stop
A/B	A frequency or B frequency	A frequency = B frequency
NR	NB or NR options	Only display the spectrum, only display the waterfall chart, display the spectrum and the waterfall chart at the same time

DSP	NR, NB, PEAK threshold setting	Turn off NR or NB
PA	Transmitting power setting	High, Low transmission power gear selection
BW	Digital filter selection	Spectrum bandwidth setting, spectrum reference level setting, spectrum refresh rate setting.
▪	*	5W enable CW long tone transmit to adjust the antenna standing wave.
Direction key left	Left selection or decrement value operation	*
Direction key right	Right selection or increment value operation	*
Direction key up	Up choose	Fast frequency improvement
Direction key down	Down choose	Fast frequency reduction
Menu	Confirm	Application interface, back

### Indicator light

	Red Light	Green Light
Transmitting	On	
Receiving		On
Program Exception		Flicke

## Main interface

- 1, Digital filter
- 2, Waterfall illustration
- 3, Frequency spectrum
- 4, Band A/B instructions
- 5, Mode
- 6, SWR, AUD, ALC instrument
- 7, S meter (transmitting power meter when transmitting)
- 8, Different frequency transmitting frequency
- 9, Main frequency display (inter-frequency receiving frequency)

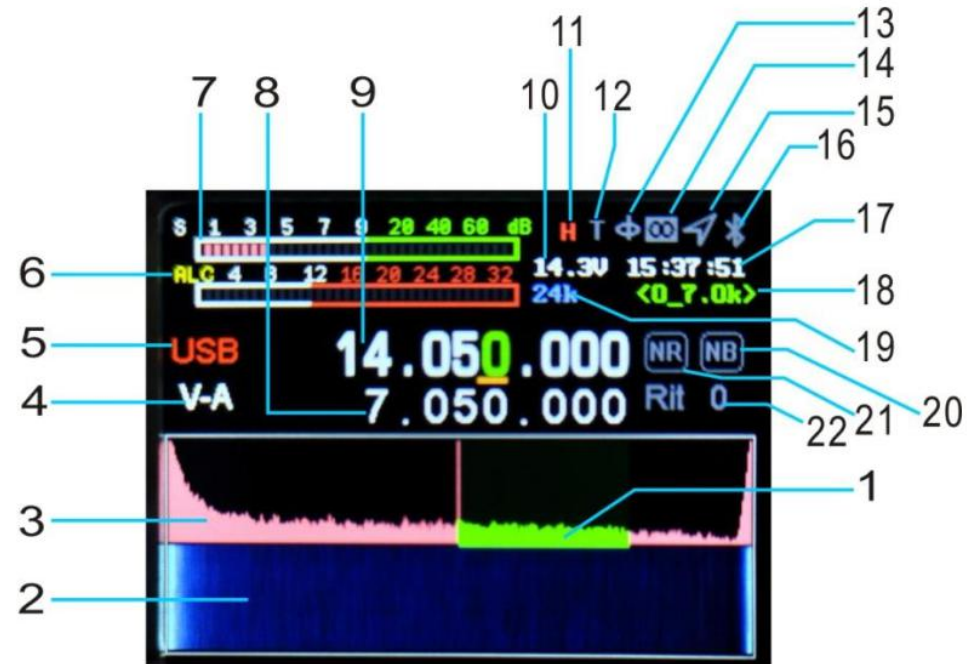

- 10, Voltage
- 11, High/Low power
- 12, Tune enable
- 13, Electronic compass
- 14, LoRa
- 15, GPS
- 16, Bluetooth
- 17, Time
- 18, Digital filter width
- 19, Frequency Spectrum bandwidth
- 20, NB indicator
- 21, NR indicator
- 22, RIT/XIT offset

## Band Selection Operation

Short press the **【BAND】** button to pop up the frequency band selection interface, press the direction key to select the frequency band, and press the MENU key to confirm.



## Different Frequency

Press **【SPLIT】** to display the different frequency, then press again to turn off the different frequency. Press the left and right direction keys to select the frequency, and press the up and down direction keys to increase or decrease the frequency. The upper row of frequencies is the receiving frequency and the lower row is the transmitting frequency. Press **【A/B】** to switch.

## AF audio Setting

Short press the **【AF】** button to enter the AF interface, use the left and right direction keys to select the setting item, and use the up and down buttons to set the value.

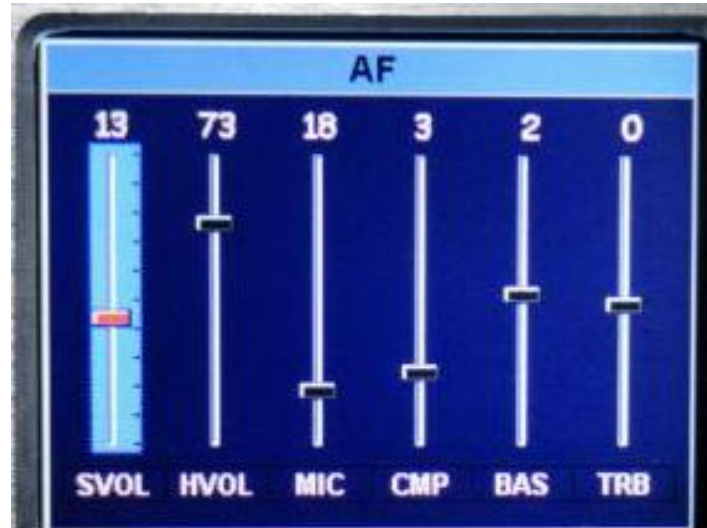

VOL: Volume

MIC: MIC gain

CMP: MIC Compression ratio

BAS: Bass

TRB: Treble

## RF setting

Short press **【RF】** to enter the RF parameter setting interface, use left and right direction keys to select the setting item and use the up, and down keys to set the value.

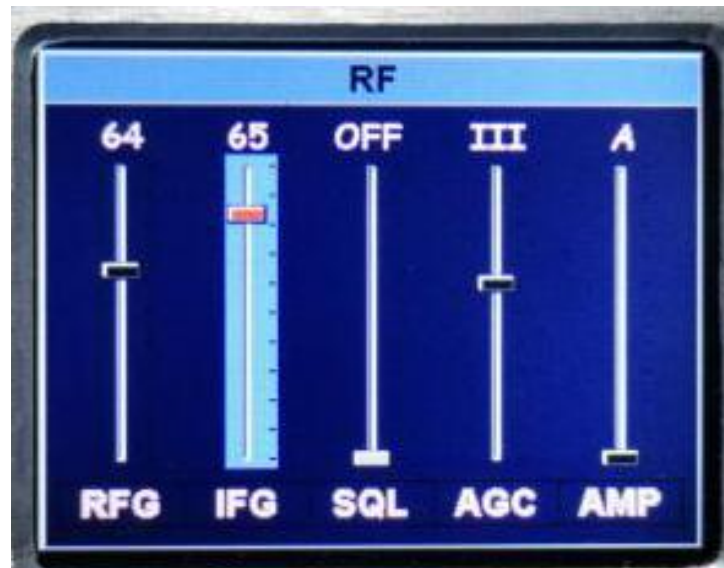

RFG: RF gain

IFG: IF gain

AGC: Automatic gain adjustment speed

SQL: Squelch level (FM)

AMP: Pre-amplification

## USB sound card data output format setting

Long press the **【RF】** key to enter the USB sound card data output format selection interface, and use the up and down keys to select the output mode. Press and hold again to exit.

MIC: Select when using a microphone.

USB: Select when entering digital modes such as FT8/HRD/N1MM/LOG32/RTTY.

SDR: Select when using software such as SDR#/HDSDR.

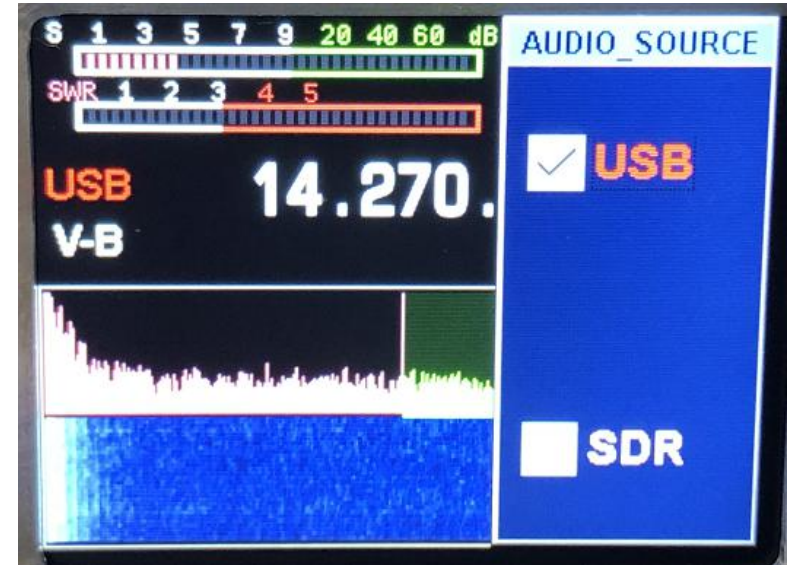

## Transceiver beat frequency setting

Long press **【R/X】** to open the beat frequency setting interface. Short press to select the receiving beat frequency RIT, and then short press to set the transmitting beat frequency XIT. Use the left and right direction keys to set the frequency deviation. Then long press **【R/X】** to exit.

Beat frequency = key display value \* 20Hz.



## Transceiver mode setting

Short press **【Mode】** button to select the mode.

FM mode: long press to select NFM/WFM.

SSB mode: Long press to select USB/LSB.

Followed by recycling AM, FM, USB/LSB, CW.



## Tune operation<sup>\*1</sup>

1. Short press **【Power】** key to switch to SWR standing wave instrument.
2. Short press **【Tune】** key, HS2 will automatically enter tuning mode. HS2 will emit a short “dada~” voice. The “T” on the screen will become green. Long press **【Tune】** if you want to exit the tuning mode halfway. Tuning fail, the “T” on the screen will become gray. Tuning success, it will become green. In the green state, we can short press **【Tune】** to turn off the tune.
3. Long press **【•】** HS2 will automatically enter into CW mode 5W long tone transmission. You can see your antenna SWR value, so you can adjust your antenna feed system easily. Short press **【•】** to exit.

<sup>\*1</sup>: The program is constantly improving and upgrading



## A/B frequency operation

Short press **【A/B】** button to switch A/B frequency,  
 Long press A frequency=B frequency.



## NR/NB noise suppression setting

Short press **【NR】** to turn on NR/NB, and then short press to switch NR/NB. As usual, we select NR.

Short press **【BW】** to turn on digital filter(green), adjust the right and left key to make the width to 4.8k, at this time, the NR will work.

Long press the **【DSP】** key to turn off NR/NB.



## Spectrum and waterfall display setting

Long press the **【NR】** key to select and display the waterfall chart, and long press to select and display the spectrum chart, and long press the waterfall chart and the spectrum chart to display at the same time.

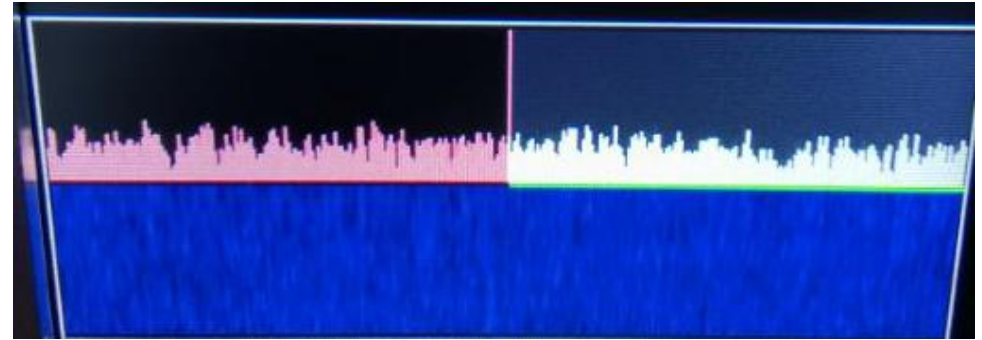

## Spectrum parameter display setting

Long press the **【BW】** key to set spectrum bandwidth, reference level, refresh rate, left and right direction keys to select setting items, up and down direction keys to set value.

SPAN: Spectrum bandwidth.

REF: Spectrum reference level.

SPEED: Spectrum refresh rate.

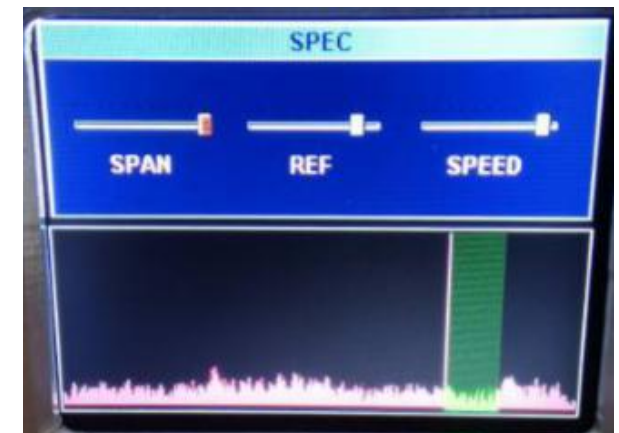

## Digital filter operation

Short press **【BW】** key to select digital filter(green color), left or right direction key to select filter bandwidth, short press **【BW】** key to ensure filter bandwidth and exit(the green will become white).



## Transmitting power setting

Long press **【PA】** key to select power setting, up and down keys to increase or decrease power. Short press **【PA】** key to switch High and Low power.



## Application menu operation<sup>\*1</sup>

Long press the **【Menu】** key to enter the menu interface, long press the **【Menu】** key to exit the menu interface, left and right, up and down keys to select the application, and short press the **【Menu】** key to select the application.



<sup>\*1</sup>: SDR radio has unlimited possibilities as long as the hardware support, Some functions we don't describe are reserved functions, temporarily unavailable.

## 1. FM Broadcast operation\*RADIO

Short press the left and right buttons to search channels by 100k steps, long press the left and right buttons to search channels automatically. Press the up and down buttons to increase or decrease the volume. Long press【MENU】to exit the FM radio function.



## 2. Bluetooth setting\*BT

Press the 【Menu】 key to select the master-slave mode. Connect the phone, tablet, etc. to the slave mode.

Select the master mode by connecting a Bluetooth headset, etc.

### Master mode:

Press the up and down keys to select the function button, and press the 【Menu】 key to confirm. Search Bluetooth headset Select search all Bluetooth slave devices, select Bluetooth slave device to connect.

Note: Temporarily unavailable

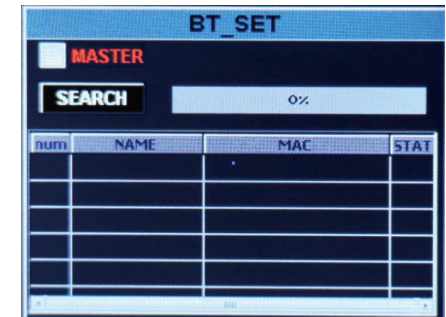

## 3. GPS operation\*DIR

Enter the menu to directly display the UTC time, latitude and longitude, speed, direction, altitude, etc. received by the GPS module.

Note: Some of them can be used, still in developing

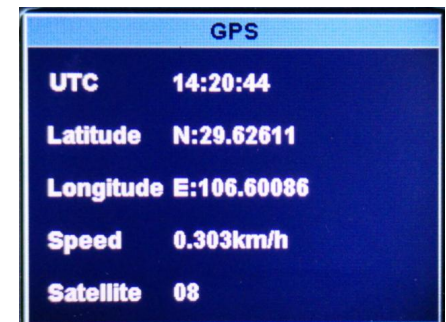

## 4. LoRa operation\*Q-CHAT

Directly display when receiving message, press the keyboard to input the information, and click TX to transmit the information. It need two radios for test this function.

Note: Still in developing

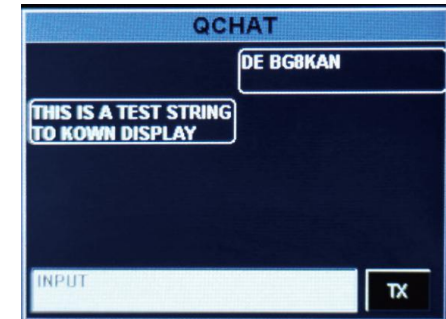

## 5. Electronic compass operation\*MESSAGE & \*MUSIC

Note: Still in developing

## 6. VSWR

Press **【MENU】** to enter, long press **【MENU】** to exit. Works on HF band only. You also can set the VSWR value in the setting list.



## 7. Setting\*SET

- 7-1 key led
- 7-2 Out-band-en
- 7-3 Tx-en: turn on/off transmit
- 7-4 key-volume: the key touch beep
- 7-5 Backlight: Set the screen brightness
- 7-6 led-brightness: set the receive indicator led brightness
- 7-7 Hour
- 7-8 Minute
- 7-9 Second

- 7-10 Fan-en-temp: the temperature which fan start to work.
- 7-11 VSWR-protection
- 7-12 VSWR-tuner
- 7-13 TOT-timer
- 7-14 FW-version

# Rear panel interface

## ① Antenna interface

HF/50MHz/144MHz/430MHz antenna port (M type), the output impedance is 50Ω.

## ② DC power interface .

Radio power interface, the specification is 5.5\*2.5. Use the standard DC power cord to connect to a regulated power supply or battery. The power supply must be able to provide a current of 6A@(12~16.8)V to ensure the full power output of the radio.

## ③ Sleeve USB interface

It is used to connect the USB cable to the computer and can output audio, digital and IQ signals.

## ④ RS232 serial interface

It is used for connecting peripheral smart devices, such as external VFO knob.

## ⑤ Electric key interface

This interface is a 3.5mm three-core interface, used to connect electronic automatic key control or ordinary hand keys.

## ⑥ Network interface

Used for remote control and remote firmware upgrade.

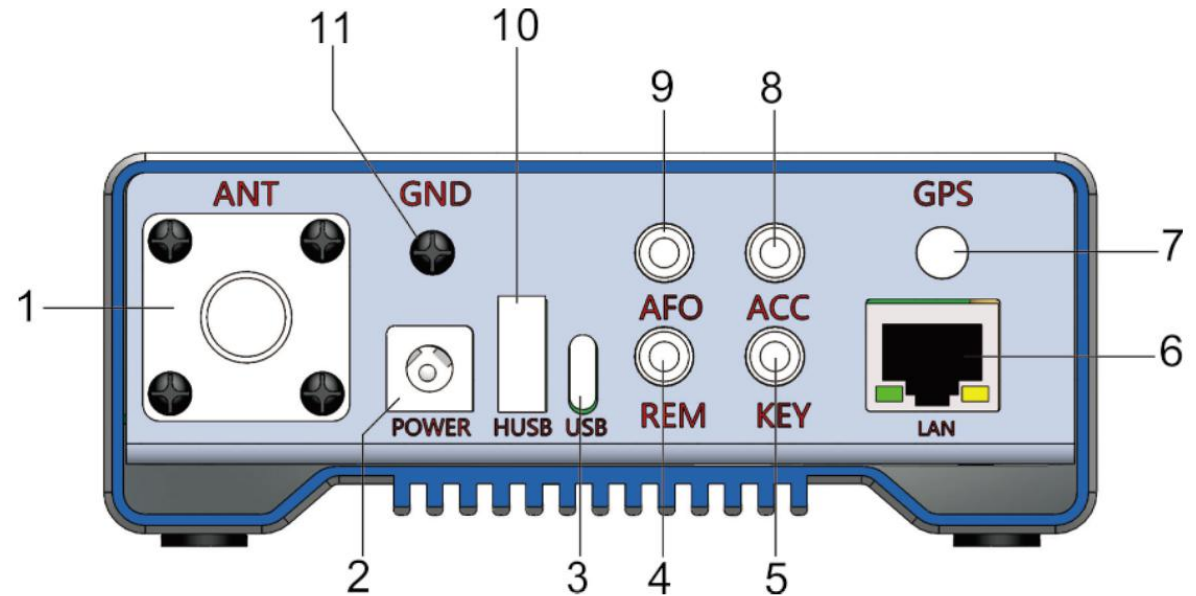

⑦GPS antenna port

Connect an active GPS antenna.

⑧PTT control output.

PTT transceiver used to control the power amplifier.

⑨Audio output.

Demodulated audio output

⑩Host USB interface

The function of this interface is temporarily reserved and used with caution for charging external devices.

⑪Grounding post

Note: To achieve the best performance and ensure safety, you can use a short and thick copper stranded wire to connect this ground terminal to the ground well.

# Interface definition

## Key

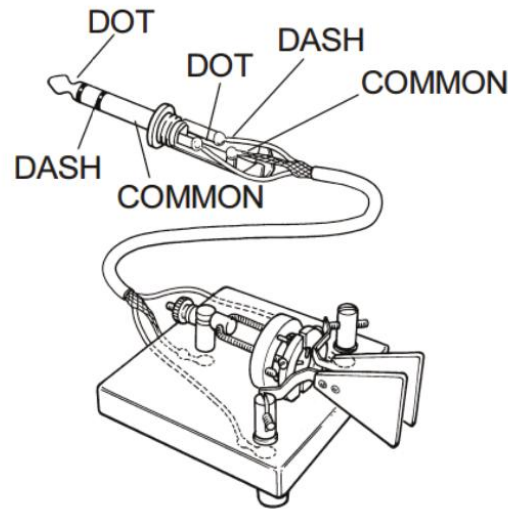
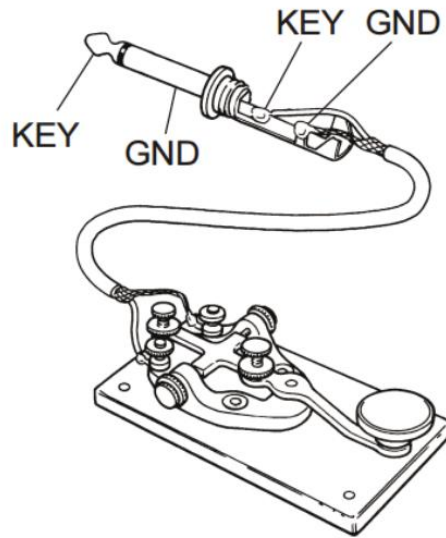

## Power

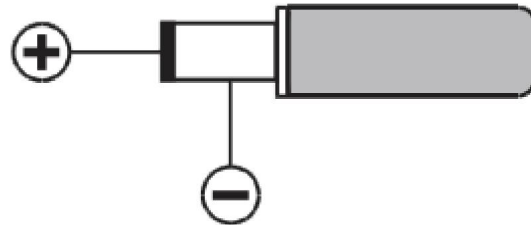

## Audio output/headphone interface

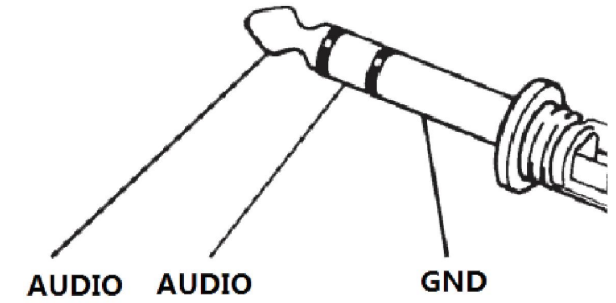

## Hand microphone

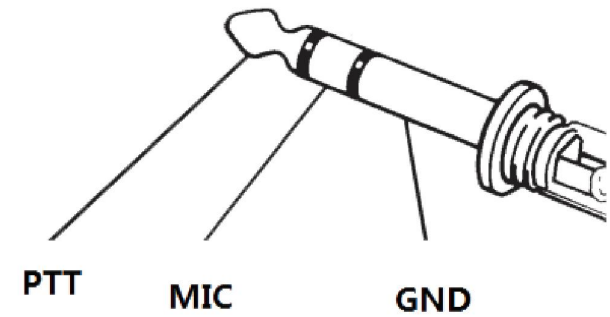





# Transmitting operation

Please follow my guide to learn how to quickly set up and use your new equipment HS2. You must really want to use it to communicate. Below we will guide you to the first QSO. You will get an unparalleled experience from this brand new device. Now, we begin to understand how to operate it!

## ● Turn on and off HS2

1. To turn on the radio, simply long-press the power button  for one second.
2. To turn off the radio, simply long-press the power button  for one second.

## ● Frequency band selection

1. The frequency range of HS2 is very wide. Short press **【Band】** to bring up the frequency band menu
2. Short press the arrow keys to select, short press **【Menu】** to confirm the frequency band.

## ● Frequency selection

1. Short press the left and right direction keys to select the cursor position, short press the up direction key to adjust the required frequency, and long-press the up and down direction keys to quickly select the required frequency.
2. Input the required frequency by the direct numeric keyboard.

For example: if you want to enter 14.270MHz, press the numeric keyboard: 014270000 or 14.270000, and then press the menu key **【Menu】** to confirm.

## ● Mode selection

1. The whole HS2 supports LSB, USB, CW, AM, FM. Short press **【Mode】** key to select, LSB and USB need to long press **【Mode】** key to switch, CW and CWR long press **【 Mode】** key to switch.

## ● Transmit power selection

1. Short press **【PA】** to enter the transmit power adjustment and use the up and down direction keys to adjust the value.
2. Long press **【 PA】** to quickly select the 5W and 20W sections, and each section can be fine-tuned by the up and down direction keys.

●Receive volume, MIC gain

1. Short press the **【 AF】** button to enter the AF interface, use the left and right direction keys to select the setting item, and use the up and down buttons to set the value.

VOL: volume

MIC: MIC gain

CMP: MIC compression ratio

BAS: Bass

TRB: Treble

After a simple setup is completed, you can now communicate happily. Usually, LSB mode is used below 7Mh, USB mode is used above 14MHz, and FM mode is used above 28MHz. Please check your radio license before launching, and abide by local laws and regulations. The HS2 will be locked before launching (prohibited from launching). Please open it after complying with legal regulations.

## SSB communication

1. Press the **【Mode】** key to select one of the SSB (LSB or USB) modes. If you are operating at 7MHz or below, please select LSB mode. If you are operating at 14MHz or above, please select USB mode.
2. Short press **【Power】** key, the screen switches between ALC, SWR, AUD meter display.
3. Press the PTT button on the microphone and speak into the microphone in a normal voice, while observing the AUD meter display. When the microphone enters the actual voice level, there will be a corresponding amplitude display on the AUD meter. Release the PPT button to return to the receive mode.
4. If the AUD meter shows too high or too low, you can reset the microphone gain value as follows: Long press the **【AF】** key for one second to enter the selection mode, select the MIC item in the left and right direction, and set up direction key Set value, long press **【AF】** key again to exit. Speak into the microphone until AUD appears at the peak of your voice.

## CW communication

When using hand keys, automatic keys, semi-automatic keys, an external electronic key control or a computer-generated keyboard device, please follow the steps below:

1. Insert your 3.5mm (three-phase or two-phase) plug into the KEY jack on the rear panel.
2. Short press **【Mode】** to select a CW mode (CW or CWR), "CW" mode uses the carrier input on the USB side, and CWR (reverse) mode uses the input on the LSB side.
3. Long press **【BAND】** key to enter CW set. Up and down arrow keys on the keyboard to select an option and use the left and right arrow keys to adjust the settings within the option.
  - 3-1, KEY MODE left and right direction key selection content: manual electric key automatic electric key.
  - 3-2. KEY SPEED automatic key code rate, the greater is the value, the faster is the speed.
  - 3-3. TX-RX CW transmission and reception switching time, the greater is the value, the greater is the delay.
  - 3-4. STF CW sidetone audio. 3-5. STG CW sidetone volume. 3-6. TRAINING, when turn on the CW will not output power when the key is connected.



## FM communication

The HS2 supports full-band FM mode transmission and reception. It is usually used for FM communication above 28MHz in short-wave communication. 29.6MHz is called the magic band by the HAM community. It will be opened in a short time in the summer of the year, which is very challenging.

1. Short press **【Mode】** key to find FM mode, long press **【Mode】** key to switch between WFM mode and NFM mode.
2. HS2 includes FM section FM, you can communicate with ordinary walkie-talkies, or you can go to a local relay station.
3. Short press **【RF】** key, left and right direction keys are to select SQL, squelch option, up and down direction keys are to set squelch level.

## Relay operation

1. Set the required frequency, for example, repeater parameters (downlink 145.670MHz, uplink 144.130MHz, uplink and downlink analog mute 88.5) are set as follows:

1-1. we press SPLIT to display the different frequency, and then press to turn off the different frequency. The upper row of frequencies is the receiving frequency, that is, the relay downlink, press the left and right direction keys to select the frequency, press the up and down direction keys to increase or decrease the frequency, or directly enter the numeric keyboard: 14567000, the lower row of frequencies is displayed as the transmission frequency, that is, the relay upstream frequency, you need to press the A/B key to switch to the upper row, directly enter 14413000 on the keyboard, and then press the A/B key to switch to the lower row.

1-2. The tone set, long press **【SPLIT】**, up and down keys to choose R\_CTSC(receive T\_CTSC(transmit), buttons to set the tone frequency, long press **【SPLIT】** to exit the sound settings. And you also can set 1750Hz here.

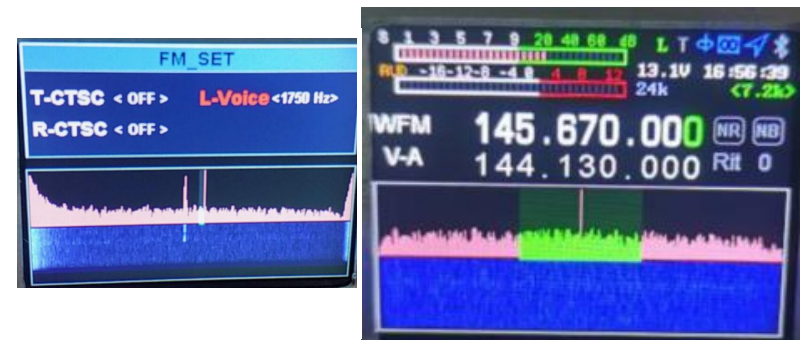

## AM communication

1. Press the **【Mode】** key to select the AM mode and set the required frequency
2. The AM mode input RF power is 5W

## Data communication RTTY

HS2's "RTTY" working mode is based on the long-term use of amateur radio, based on the LSB carrier. If you want to use the USB carrier for "RTTY" operation, you need to set up the user, please refer to the following introduction.

1. Connect your computer and HS2 via USB connection.
2. Long press the RF key to enter the USB sound card data output format selection interface, and use the up and down keys to select the output mode. Press and hold again to exit. Select **【DIGI】** digital mode.
3. At this time, you can search on the frequency, if there is an RTTY signal, the relevant computer software can decode.

## Customize digital pattern mode

HS2 cooperates with mobile phone APP software HAM-BOX to realize a custom digital communication mode, which requires the same settings for both parties.

1. Find the mobile phone Bluetooth search HS2 and pair and connect.
2. Open the mobile phone APP software HAM-BOX and set the relevant communication mode (requires the same communication side). Then the phone operation sends a text, pictures, coordinates, etc.

## CAT control

HS2 has a CAT system, so you can control the walkie-talkie with a personal computer. Multiple control operations can be fully automated with the click of a mouse, and control of third-party software packages (such as radio log software for games) is also supported so that HS2 can be used for communication without (additional) operators. The CAT protocol is compatible with FT-817, so the MODEL of FT-817 station is selected for CAT control. The CAT control USES a TYPE-C USB cable to connect to the computer, and the serial driver works only on Window 10. The USB cable is also integrated with the sound card, and only one USB is needed for CAT control and data transfer. HS2 only supports Windows 10 operating system. SDR software on the computer side and APPHAM\_BOX on android system developed by Ailunce can fully control the radio. HS2 also support a wide range of third-party control software packages.

# Computer third-party software setting operation

## 1, JTDX setting

1-1. The computer operating system only supports WIN10. Please use the TYPE-C USB cable to connect to the computer radio. After a successful connection, enter the computer device manager. You can view the port (USB serial device COM\*). Here I display COM4.

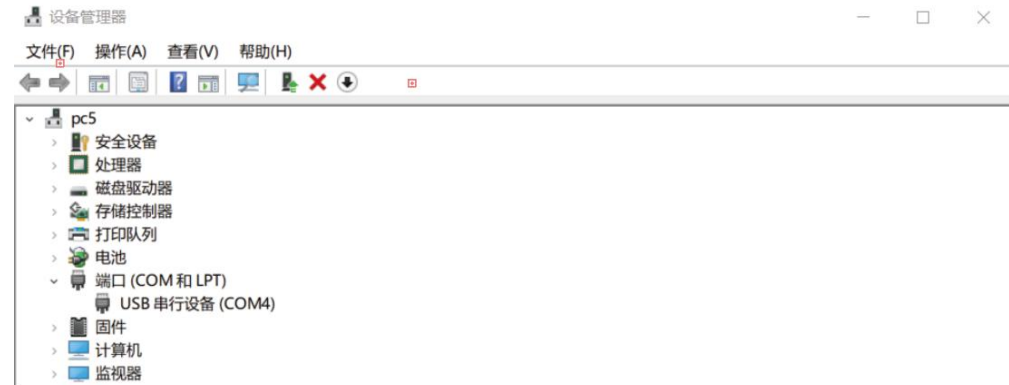

1-2. Set the USB mode on the radio terminal, long-press the **【RF】** key to enter the USB sound card data output format selection interface, use the up and down keys to select the output mode **【USB】**, and then long press to exit.

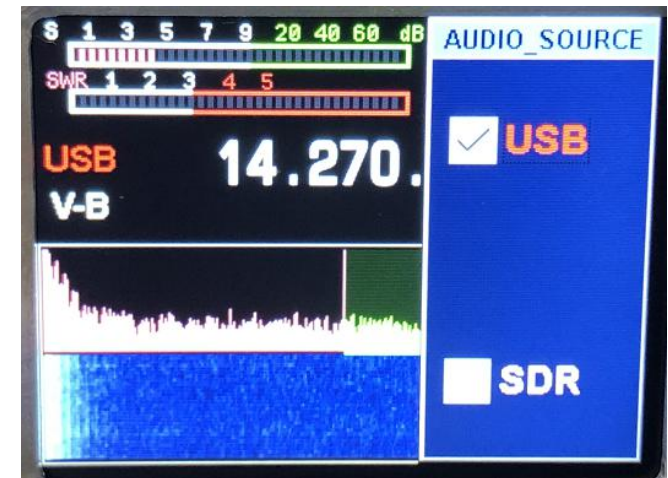

1-3. Open the FT8 software JTDX setting interface

The radio station chooses FT-817, the port number chooses the COM4 that the computer checks before, the PTT way chooses CAT control, just ignore the rest, click test CAT, when connecting successfully it will display green.

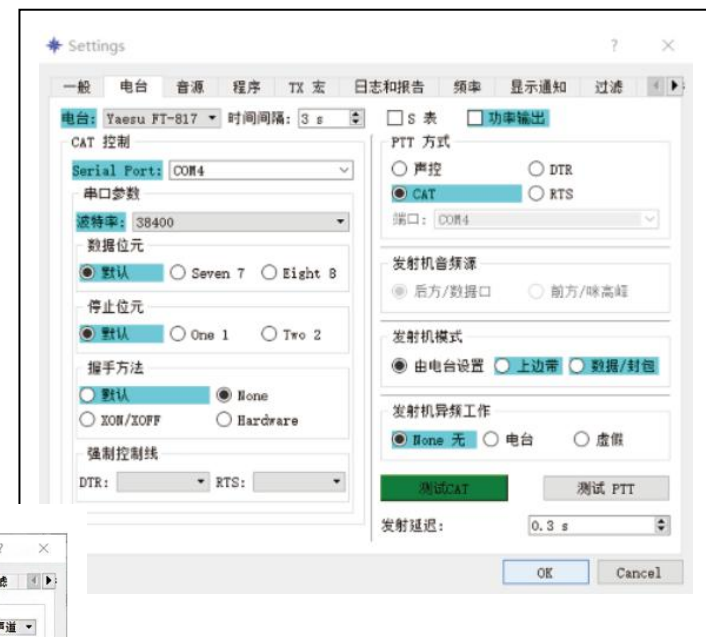

1-4, The sound source settings are as follows

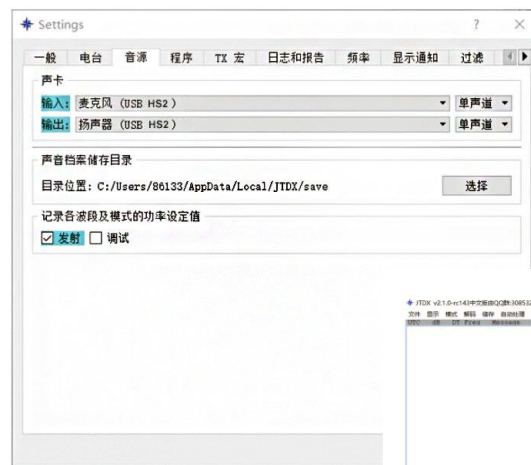

1-5. Software working interface after it has been set.

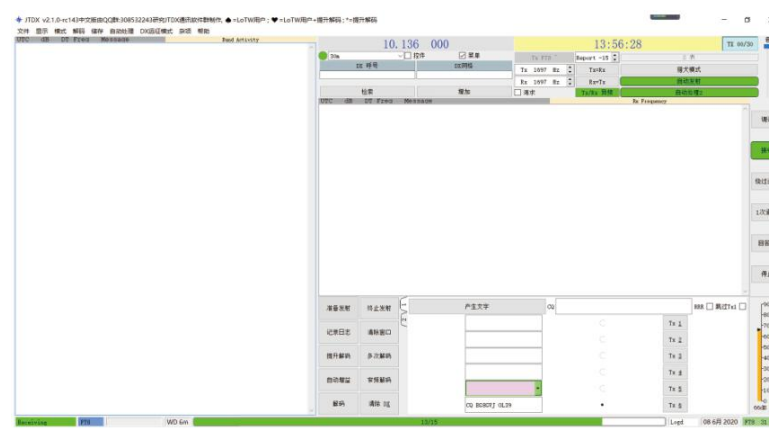



## 2, HRD setting

2-1. The computer operating system only supports WIN10. Please use the TYPE-C USB cable to connect to the computer radio. After the connection is successful, enter the computer device manager to view the port (USB serial device COM\*). I display COM4 here.

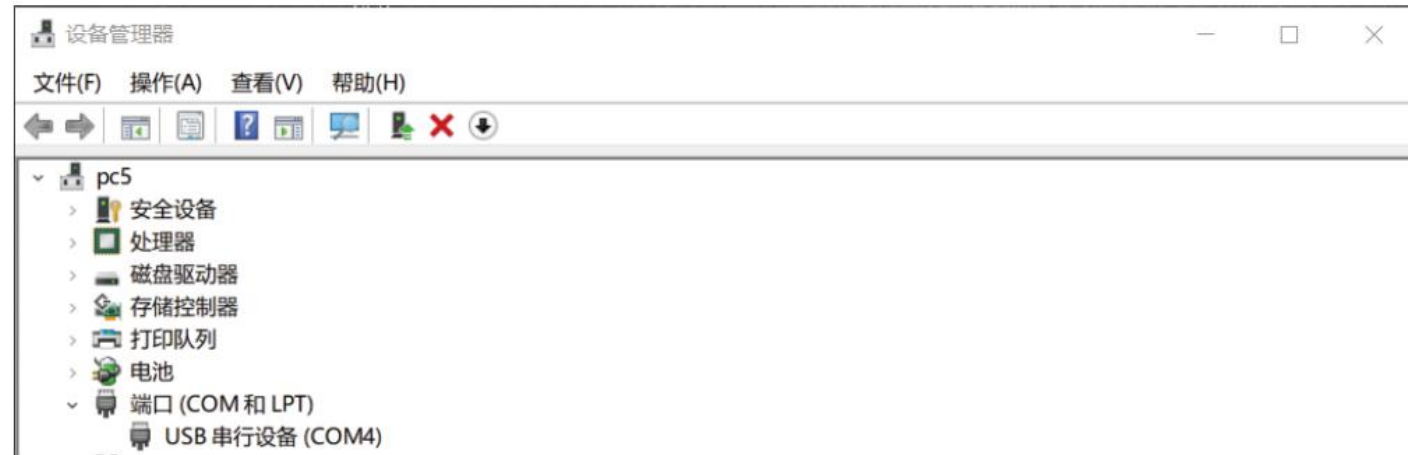

2-2. Set the USB mode on the radio terminal, long-press the **【RF】** key to enter the USB sound card data output format selection interface, use the up and down keys to select the output mode **【USB】**, and then long press to exit.

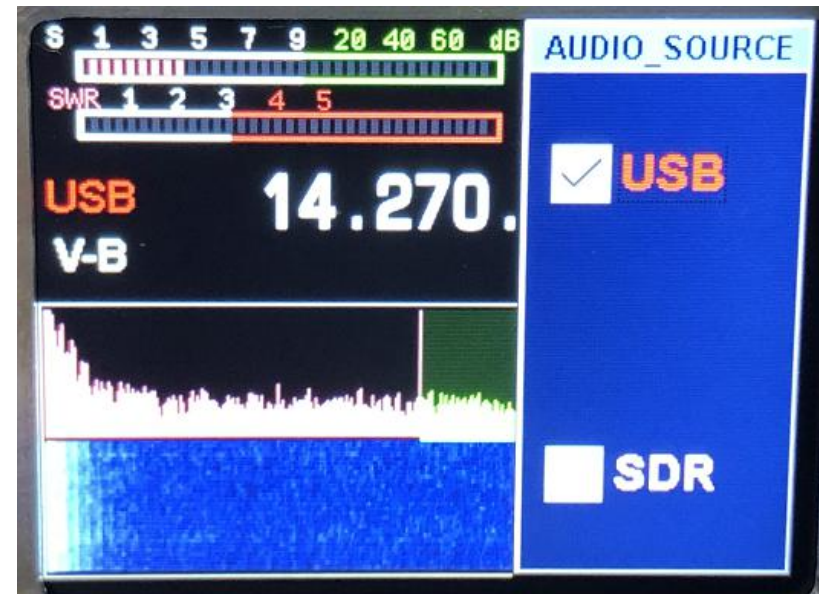

2-3. When you open the HRD for the first time, the options dialog box will pop up automatically. Click Connect after the settings are completed according to the figure. If the connection is successful, you will directly enter the software interface. If not, you will be noticed.

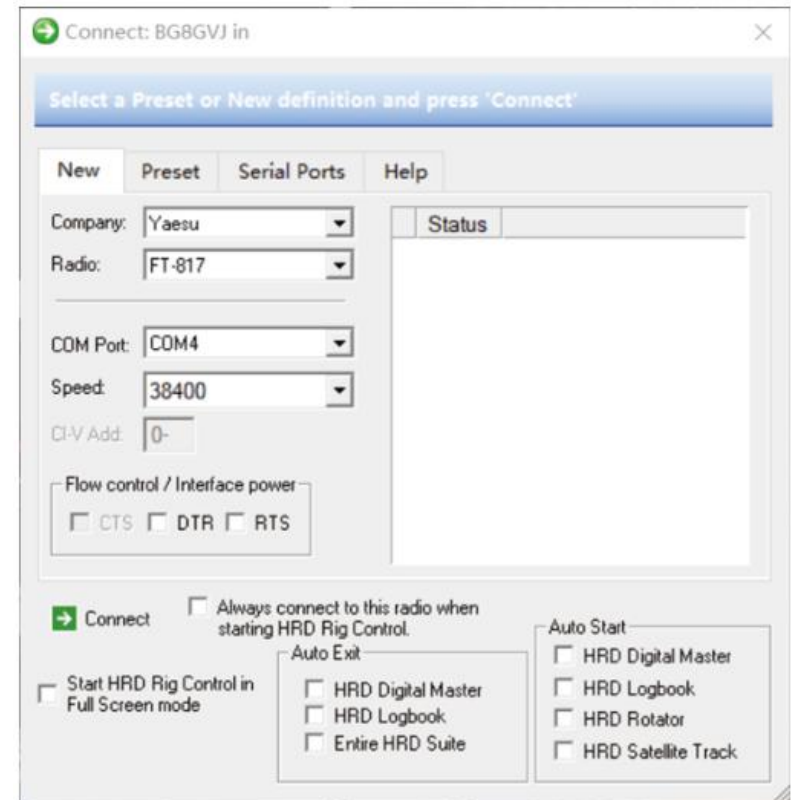
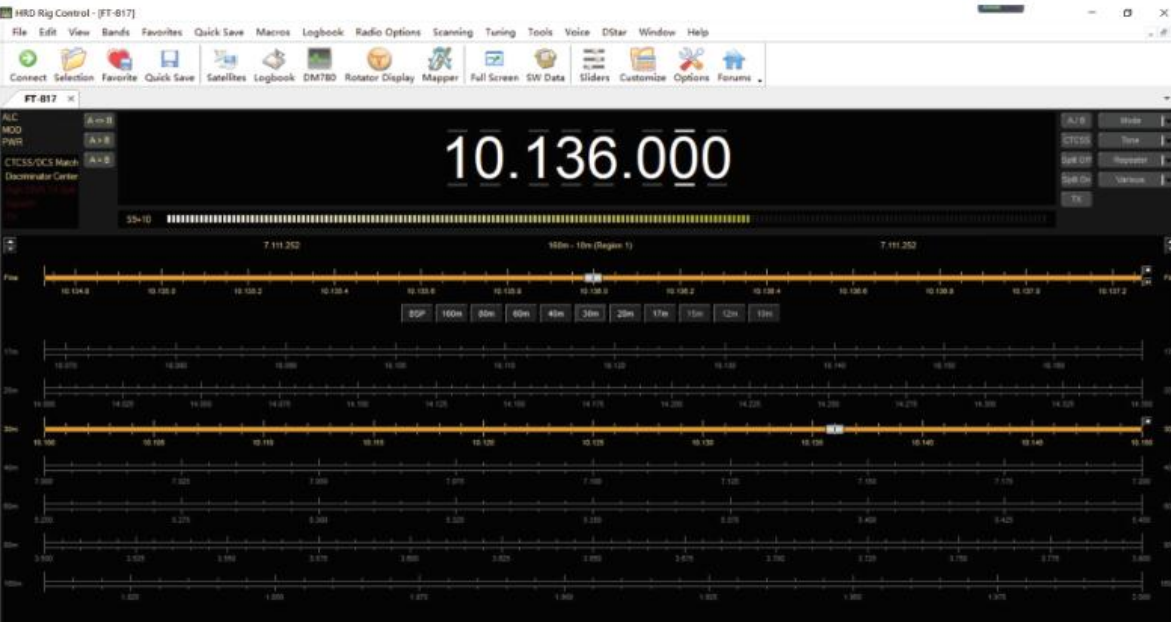

2-4. After successful connection it enters the software interface, the software can operate all the functions of the radio.

### 3, N1mm setting

3-1. the computer operating system only supports WIN10. Please use the TYPE-C USB cable to connect to the computer radio. After the connection is successful, enter the computer device manager. You can view the port (USB serial device COM\*). Here I display COM4.

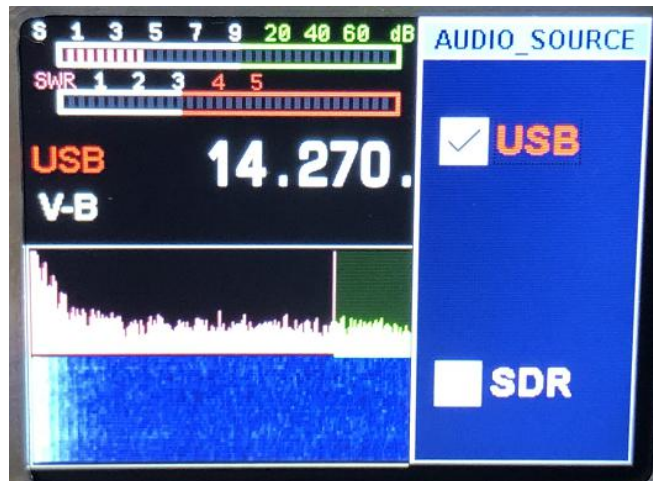

3-2. Set the USB mode on the radio station, long-press the **【RF】** key to enter the USB sound card data output format selection interface, use the up and down keys to select the output mode **【USB】** , and then long press to exit.

3-3. Open the N1MM setting menu and set the parameters as shown below.

Click SET to enter the further setting menu.

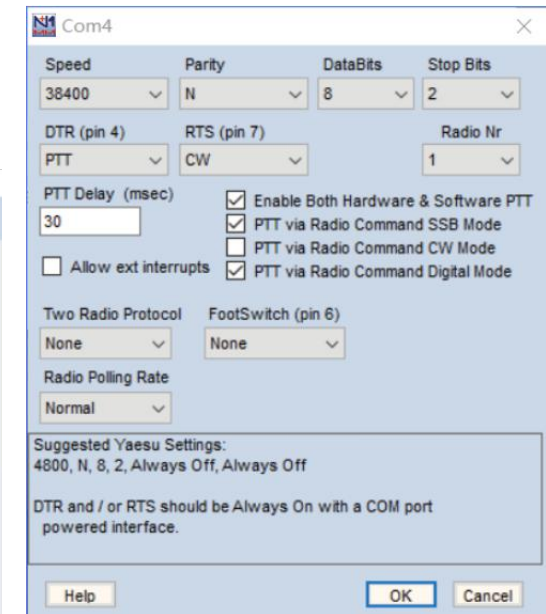
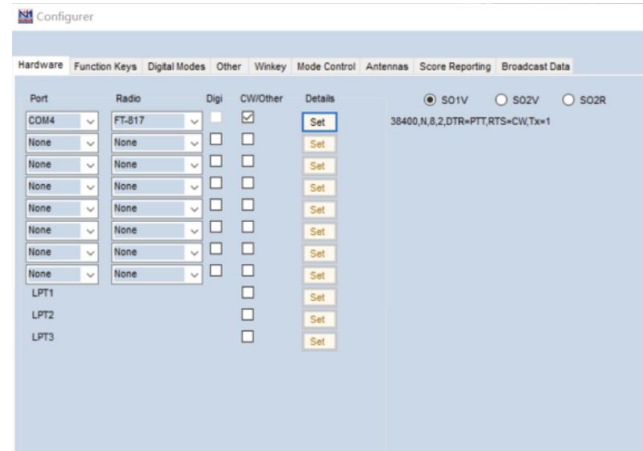

3-4. After a successful setting, the software can fully control the radio station.

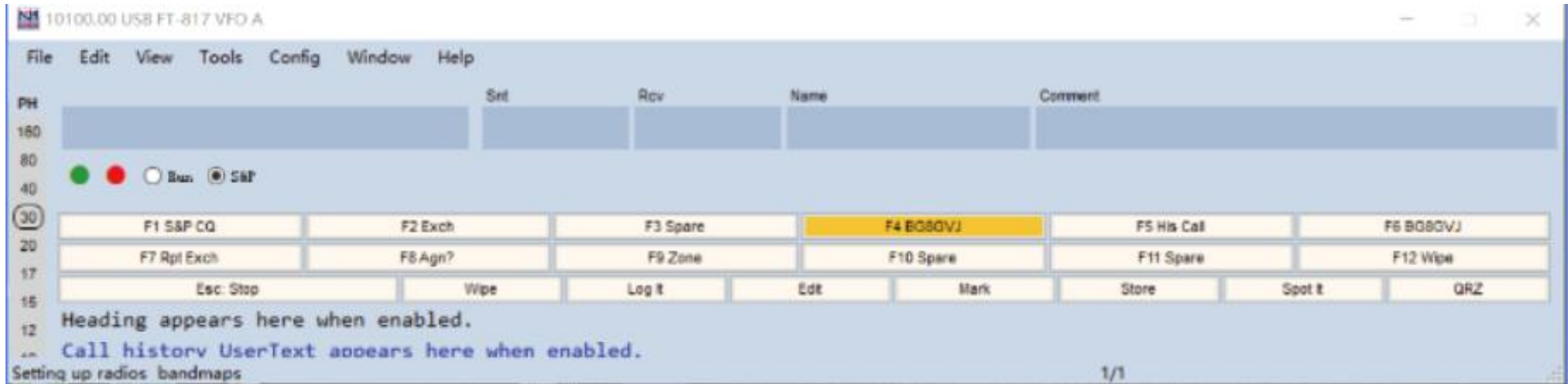

## 4, HSDR setting

4-1. The computer operating system only supports WIN10. Please use the TYPE-C USB cable to connect to the computer radio. After a successful connection, enter the computer device manager. You can view the port (USB serial device COM\*). Here I display COM4.



4-2. Set the USB mode on the radio station, long-press the **【RF】** key to enter the USB sound card data output format selection interface, use the up and down keys to select the output mode **【SDR】** , and then long press to exit.



4-3. Open the HSDR software and set the parameters in sequence according to the figure.

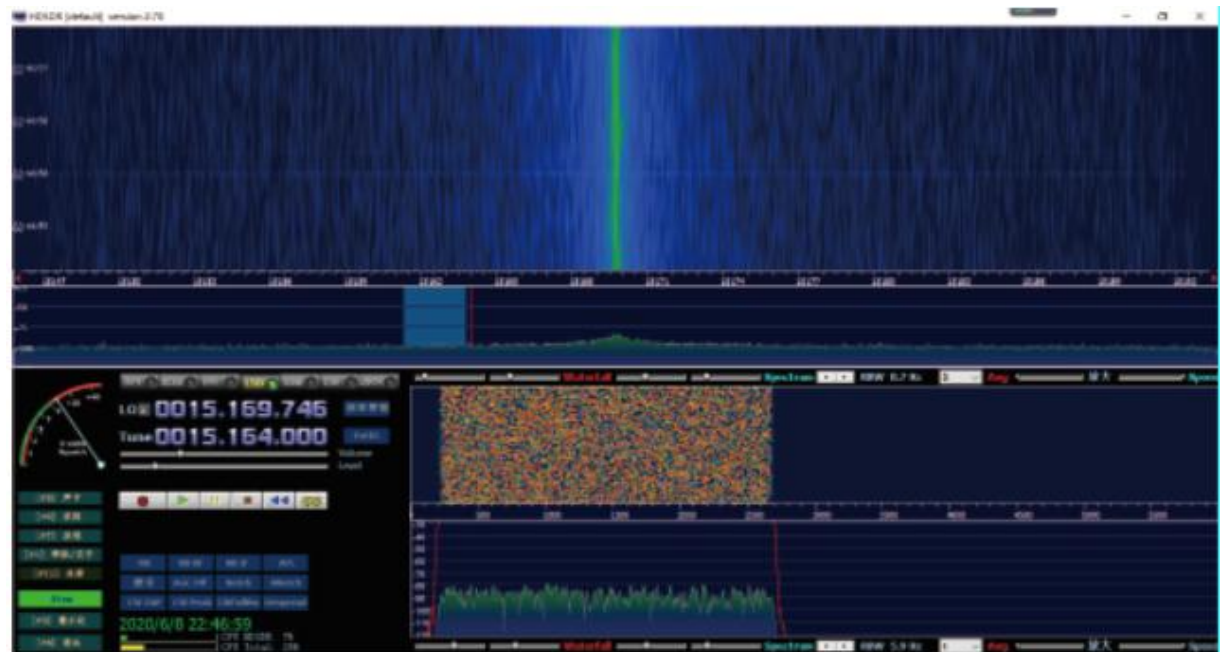

4-4. Select the RX input of the sound card as microphone USBHS2, and select the sound card of the computer as the output.

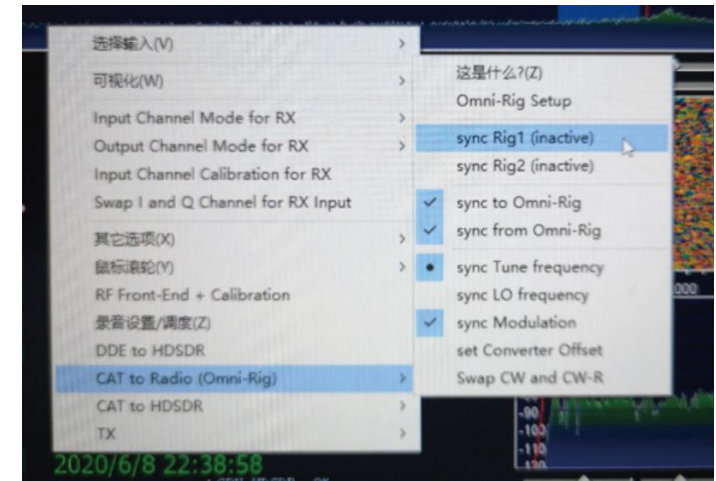
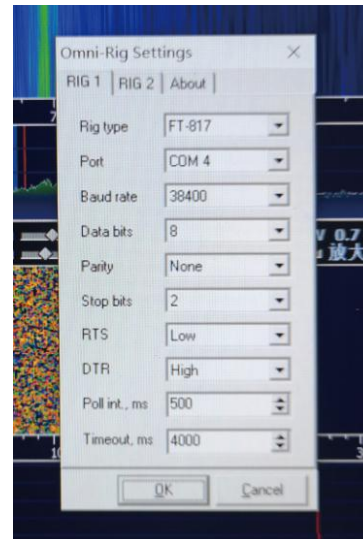
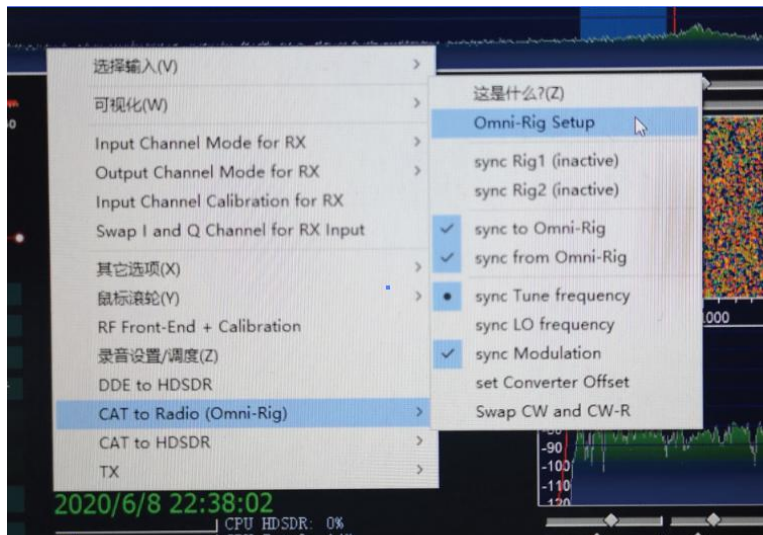
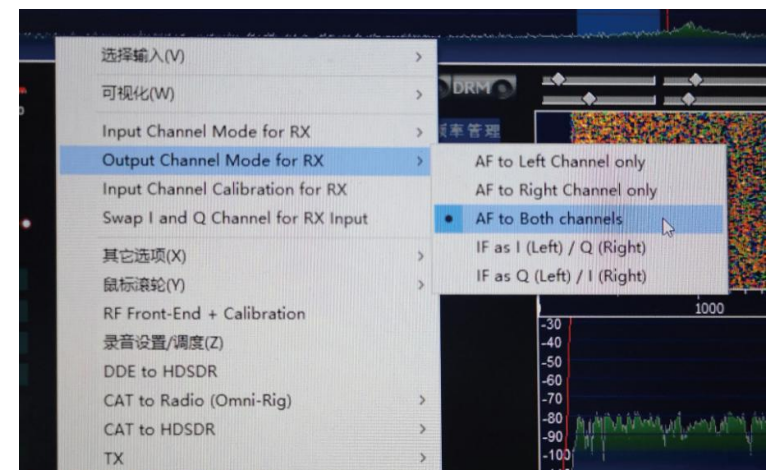
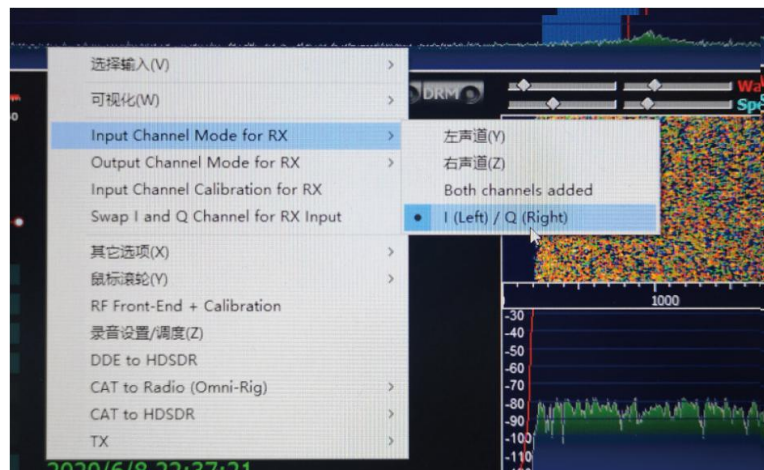
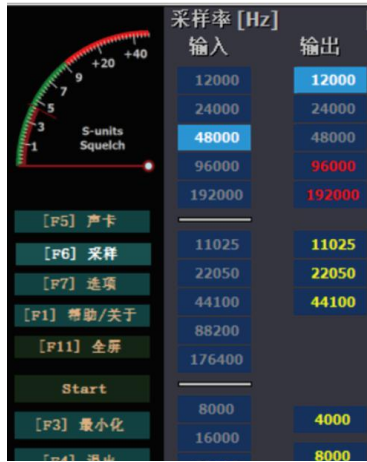

After it is set, click **【Start】** on the HSDR interface to use it.

## 5, Bluetooth adapter and radio realize wireless connection

The Bluetooth adapter is developed by us and the HS2 can realize the wireless connection between the computer and the radio. You can put the radio on the balcony, and the laptop and tablet computer can control the radio on the sofa in the living room.

### Mobile APP

The mobile app HAMBOX is developed by Retevis Company which has fully controlled the radio function, and some functions are free to use.

**Note:** Some functions are not fully developed, temporarily unavailable. Will release it asap

### PC software

The PC software is developed by Retevis Company which has fully controlled the radio function, and some functions are free to use.

**Note:** Some functions are not fully developed, temporarily unavailable. Will release it asap

## Receiving advanced operation

HS2's power-on state is the receiving state. In order to get a better listening experience, you need to follow me to understand the advanced operation of the machine.

1. Select the desired frequency, for example, 14.270MHz\USB.
2. Short press the **【AF】** button to call up the VOL volume adjustment. Use the up and down direction keys to adjust the volume and adjust the appropriate volume. Short press the **【AF】** button again to save and exit.
3. Short press the **【RF】** button to bring up the RF parameter setting interface. Use the left and right direction keys to select the setting item, use the up and down keys to set the value, and press the **【RF】** key again to save and exit.

3-1, RFG: RF gain.

3-2. IFG: IF gain.

The combination of RFG and IFG enables the receiver to achieve the highest sensitivity and the lowest amount of noise. Generally, you need to increase these two parameters if you want to hear a very weak signal, but the noise also increases. A balanced state requires careful adjustment. Usually, the IF gain can be set higher than the RF gain.

3-3, ATT: attenuation. If the signal is particularly strong, you can turn on ATT.

4. Long press the **【BW】** button to set the spectrum bandwidth, reference level, refresh rate, use the up and down buttons to select the setting item, left and right buttons to set the value, and long-press the **【BW】** button again to exit. The spectrum display shows other signals within the bandwidth.

4-1, SPAN: spectrum bandwidth, respectively 12K, 24K, 48K width

4-2, REF: spectrum reference level.

4-3, SPEED: spectrum refresh rate.

5. Display setting of the spectrum and waterfall chart

Long-press the NR key to select and display the waterfall chart, long-press to select and display the spectrum chart, and long press to display the tile chart and the waterfall chart at the same time.

6. Digital filter operation, HS2 provides a powerful digital filter.

We short press the BW button to select the digital filter. After the digital filter is turned on, the original white horizontal line on the spectrum is displayed in green. Use the left and right buttons to select the filter bandwidth. Press the BW button again to confirm the filter bandwidth and exit.

Different bandwidths can effectively avoid interference signals to achieve excellent listening effects.

7. NR/NB noise suppression setting, usually this option shall cooperate with the digital filter to achieve excellent results.

7-1. we short press **【NR】** to turn on NR/NB, and short press to switch NR/NB. Press and hold the **【DSP】** key to turn off NR/NB. Short press **【DSP】** to set the NR/NB/PEAK threshold, use the up and down keys to select the NR/NB/PEAK setting item, left and right keys to set the value, and short press **【KSP】** again to exit.

7-2. Find the required signal, turn on NR, usually the effect of NR is more obvious, then press **○6** to open the digital filter to the maximum bandwidth, and then



adjust the digital filter bandwidth a little bit. You will find that the noise will be greatly suppressed. At this time, you can also adjust the combination of the previous RFG and IFG to achieve the best reception effect.

Through the above settings, you have mastered the advanced receiving settings of HS2. Now, let HS2 explore with you in the ocean of radio waves.

## HS2 firmware upgrade

1. Open the DfuSe Demo software.
2. Plug the HS2 power supply and connect it to USB.
3. Hold down the BAND key and then hold down the POWER key. At this time, if the computer is connected to the HS2 normally, ① will display (STM Device in DFU Mode). Otherwise, please check whether the computer is properly connected to the HS2.
4. Select the firmware file \*.dru②
5. Hold down the BAND and power keys, click③Upgrade

At this point, the upgrade begins, wait for the progress bar to finish, release the button, and restart the computer.

6. If you let go of the button or power off halfway, you only need to restart the operation.

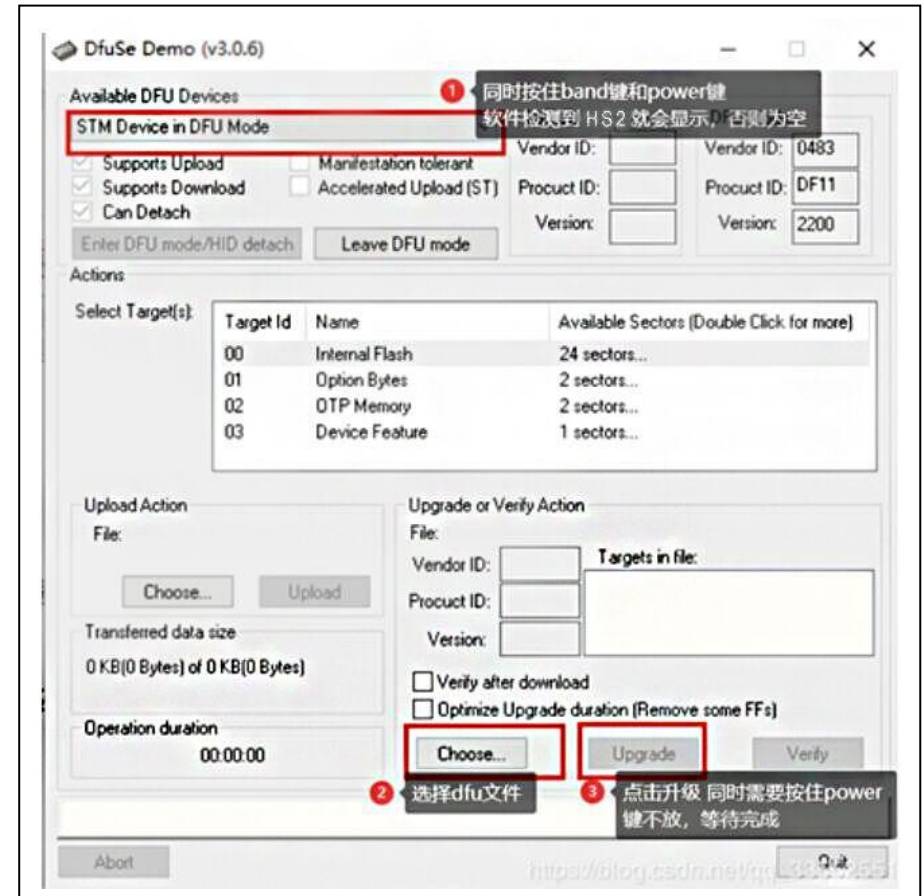

## RF ENERGY EXPOSURE AND PRODUCT SAFETY GUIDE FOR PORTABLE TWO-WAY RADIOS



**ATTENTION!**

Before using this radio, read this guide which contains important operating instructions for safe usage and RF energy awareness and control for compliance with applicable standards and regulations.

This two-way radio uses electromagnetic energy in the radio frequency (RF) spectrum to provide communications between two or more users over a distance.

RF energy, which when used improperly, can cause biological damage.

All Retevis two-way radios are designed, manufactured, and tested to ensure they meet government-established RF exposure levels. In addition, manufacturers also recommend specific operating instructions to users of two-way radios. These instructions are important because they inform users about RF energy exposure and provide simple procedures on how to control it.

Please refer to the following websites for more information on what RF energy exposure is and how to control your exposure to assure compliance with established RF exposure limits: <http://www.who.int/en/>

### **Local Government Regulations**

When two-way radios are used as a consequence of employment, the Local Government Regulations require users to be fully aware of and able to control their exposure to meet occupational requirements. Exposure awareness can be facilitated by the use of a product label directing users to specific user awareness information. Your Retevis two-way radio has an RF Exposure Product Label. Also, your Retevis user manual or separate safety booklet includes information and operating instructions required to control your RF exposure and to satisfy compliance requirements.

### **Radio License**

Governments keep the radios in classification, business two-way radios operate on radio frequencies that are regulated. by the local radio management departments (FCC, ISED, OFCOM, ANFR, BFTK, Bundesnetzagentur...).

To transmit on these frequencies, you are required to have a license issued by them. For the detailed classification and the use of your two radios, please contact the local government radio management departments. The use of this radio outside the country where it was intended to be distributed is subject to government regulations and may be prohibited.

### **Unauthorized modification and adjustment**

Changes or modifications not expressly approved by the party responsible for compliance may void the user's authority granted by the local government radio management departments to operate this radio and should not be made. To comply with the corresponding requirements, transmitter adjustments should be made only by or under the supervision of a person certified as technically qualified to perform transmitter maintenance and repairs in the private land mobile and fixed services as certified by an organization representative of the user of those services. Replacement of any transmitter component (crystal, semiconductor, etc.) not authorized by the local government radio management department equipment authorization for this radio could violate the rules.

### **FCC Requirements:**

This device complies with part 15 of the FCC Rules. Operation is subject to the condition that this device does not cause harmful interference. (Licensed radios are applicable); This device complies with part 15 of the FCC Rules. Operation is subject to the following two conditions:

(Other devices are applicable)

- (1) This device may not cause harmful interference, and
- (2) this device must accept any interference received, including interference that may cause undesired operation.

NOTE: This equipment has been tested and found to comply with the limits for a Class A digital device, pursuant to part 15 of the FCC Rules. These limits are designed to provide reasonable protection against harmful interference when the equipment is operated in a commercial environment. This equipment generates, uses, and can radiate radio frequency energy and, if not installed and used in accordance with the instruction manual, may cause harmful interference to radio communications. Operation of this equipment in a residential area is likely to cause harmful interference in which case the user will be required to correct the interference at his own expense.



**CE Requirements:**

(Simple EU declaration of conformity) Shenzhen Retevis Technology Co., Ltd. declares that the radio

equipment type is in compliance with the essential requirements and other relevant provisions of RED Directive 2014/53/EU and the ROHS Directive 2011/65/EU and the WEEE Directive 2012/19/EU; the full text of the EU declaration of conformity is available at the following internet address: [www.retevis.com](http://www.retevis.com).

**Restriction Information**

This product can be used in EU countries and regions, including Belgium (BE), Bulgaria (BG), Czech Republic (CZ), Denmark (DK), Germany (DE), Estonia (EE), Ireland (IE), Greece (EL), Spain (ES), France (FR), Croatia (HR), Italy (IT), Cyprus (CY), Latvia (LV), Lithuania (LT), Luxembourg (LU), Hungary (HU), Malta (MT), Netherlands (NL), Austria (AT), Poland (PL), Portugal (PT), Romania (RO), Slovenia (SI), Slovakia (SK), Finland (FI), Sweden (SE) and United Kingdom (UK). For the warning information of the frequency restriction, please refer to the package or manual section.

**Disposal**

The crossed-out wheeled bin symbol on your product, literature, or packaging reminds you that in the European Union, all electrical and electronic products, batteries, and accumulators (rechargeable batteries) must be taken to designated collection locations at the end of their working life. Do not dispose of these products as unsorted municipal waste. Dispose of them according to the laws in your area.

**IC Requirements:**

License-exempt radio apparatus This device contains license-exempt transmitter(s)/receiver(s) that comply with Innovation, Science, and Economic Development Canada' s license-exempt RSS(s). Operation is subject to the following two conditions:

- (1) This device may not cause interference.
- (2) This device must accept any interference, including interference that may cause undesired operation of the device.

Le présent appareil est conforme aux CNR d'Industrie Canada applicables aux appareils radio exempts de licence. L'exploitation est autorisée aux deux conditions suivantes :

- (1) l'appareil ne doit pas produire de brouillage;
- (2) l'utilisateur de l'appareil doit accepter tout brouillage radioélectrique subi, même si le brouillage est susceptible d'en compromettre le fonctionnement.

## **RF Exposure Information**

- DO NOT operate the radio without a proper antenna attached, as this may damage the radio and may also cause you to exceed RF exposure limits. A proper antenna is an antenna supplied with this radio by the manufacturer or an antenna specifically authorized by the manufacturer for use with this radio, and the antenna gain shall not exceed the specified gain by the manufacturer declared.

- DO NOT transmit for more than 50% of total radio use time, more than 50% of the time can cause RF exposure compliance requirements to be exceeded.

During transmissions, your radio generates RF energy that can possibly cause interference with other devices or systems. To avoid such interference, turn off the radio in areas where signs are posted to do so.

- DO NOT operate the transmitter in areas that are sensitive to electromagnetic radiation such as hospitals, aircraft, and blasting sites.

Portable Device, this transmitter may operate with the antenna(s) documented in this filing in Push-to-Talk and body-worn configurations. RF exposure compliance is limited to the specific belt-clip and accessory configurations as documented in this filing and the separation distance between the user and the device or its antenna shall be at least 2.5 cm.

Mobile Device, during operation, the separation distance between the user and the antenna subjects to actual regulations, this separation distance will ensure that there is sufficient distance from a properly installed externally-mounted antenna to satisfy the RF exposure requirements.

Occupational/Controlled Radio, this radio is designed for and classified as "Occupational/Controlled Use Only", meaning it must be used only during the course of employment by individuals aware of the hazards, and the ways to minimize such hazards; NOT intended for use in a General population/uncontrolled environment.

General population/uncontrolled Radio, this radio is designed for and classified as "General population/uncontrolled Radio".

## **RF Exposure Compliance and Control Guidelines and Operating Instructions**

To control your exposure and ensure compliance with the occupational/controlled environment exposure limits, always adhere to the following procedures.

### **Guidelines**

- User awareness instructions should accompany the device when transferred to other users.
- Do not use this device if the operational requirements described herein are not met.

## Operating Instructions:

- Transmit no more than the rated duty factor of 50% of the time. To Transmit (Talk), push the Push to Talk (PTT) button. To receive calls (listen), release the PTT button. Transmitting 50% of the time, or less, is important because the radio generates measurable RF energy exposure only when transmitting in terms of measuring for standards compliance.
- Transmit only when people outside the vehicle are at least the recommended minimum lateral distance away from a properly installed according to installation instructions, externally mounted antenna.
- When operating in front of the face, worn on the body, always place the radio in a Retevis approved clip, holder, holster, case, or body harness for this product. Using approved body-worn accessories is important because the use of Non-Retevis approved accessories may result in exposure levels, which exceed the IEEE/ICNIRP RF exposure limits.

population/uncontrolled Use” .

## Hand-held Mode

- Hold the radio in a vertical position with the microphone (and other parts of the radio including the antenna) at least 2.5 cm (one inch) away from the nose or lips. The antenna should be kept away from the eyes. Keeping the radio at a proper distance is important as RF exposure decreases with increasing distance from the antenna.

## Phone Mode

- When placing or receiving a phone call, hold your radio product as you would a wireless telephone. Speak directly into the microphone. Electromagnetic Interference/Compatibility

NOTE: Nearly every electronic device is susceptible to electromagnetic interference (EMI) if inadequately shielded, designed, or otherwise configured for electromagnetic compatibility.

## Avoid Choking Hazard



Small Parts. Not for children under 3 years.

**Turn off your radio power in the following conditions:**

- Turn off your radio before removing (installing) a battery or accessory or when charging battery.
- Turn off your radio when you are in a potentially hazardous environments: Near electrical blasting caps, in a blasting area, in explosive atmospheres (flammable gas, dust particles, metallic powders, grain powders, etc.).
- Turn off your radio while taking on fuel or while parked at gasoline service stations. To avoid electromagnetic interference and/or compatibility conflicts
- Turn off your radio in any facility where posted notices instruct you to do so, hospitals or health care facilities (Pacemakers, Hearing Aids and Other Medical Devices) may be using equipment that is sensitive to external RF energy.
- Turn off your radio when on board an aircraft. Any use of a radio must be in accordance with applicable regulations per airline crew instructions.

**Protect your hearing:**

- Use the lowest volume necessary to do your job.
- Turn up the volume only if you are in noisy surroundings.
- Turn down the volume before adding a headset or earpiece.
- Limit the amount of time you use headsets or earpieces at high volume.
- When using the radio without a headset or earpiece, do not place the radio's speaker directly against your ear
- Use carefully with the earphone may be possible excessive sound pressure from earphones and headphones can cause hearing loss

Note: Exposure to loud noises from any source for extended periods of time may temporarily or permanently affect your hearing. The louder the radio's volume, the less time is required before

- Your hearing could be affected. Hearing damage from loud noise is sometimes undetectable at first and can have a cumulative effect.

## Avoid Burns



### Antennas

- Do not use any portable radio that has a damaged antenna. If a damaged antenna comes into contact with the skin when the radio is in use, a minor burn can result.

### Batteries (If appropriate)

- When the conductive material such as jewelry, keys or chains touch exposed terminals of the batteries, may complete an electrical circuit (short circuit the battery) and become hot to cause bodily injury such as burns. Exercise care in handling any battery, particularly when placing it inside a pocket, purse or other container with metal objects

### Long transmission

- When the transceiver is used for long transmissions, the radiator and chassis will become hot.

## Safety Operation



### Forbid

- Do not use charger outdoors or in moist environments, use only in dry locations/conditions.
- Do not disassemble the charger, that may result in risk of electrical shock or fire.
- Do not operate the charger if it has been broken or damaged in any way.
- Do not place a portable radio in the area over an air bag or in the air bag deployment area. The radio may be propelled with great force and cause serious injury to occupants of the vehicle when the air bag inflates.

### To reduce risk

- Pull by the plug rather than the cord when disconnecting the charger.
- Unplug the charger from the AC outlet before attempting any maintenance or cleaning.



- Contact Retevis for assistance regarding repairs and service.
- The adapter shall be installed near the equipment and shall be easily accessible.

### Approved Accessories



- This radio meets the RF exposure guidelines when used with the Retevis accessories supplied or designated for the product. Use of other accessories may not ensure compliance with the RF exposure guidelines and may violate regulations.
- For a list of Retevis-approved accessories for your radio model, visit the following website: <http://www.Retevis.com>

EU Importer:

Importer:Germany Retevis Technology GmbH

Address:Uetzenacker 29,38176 wendeburg

## Guarantee

Model Number:

Serial Number:

Purchasing Date:

Dealer:

Telephone:

User's Name:

Telephone:

Country:

Address:

Post Code:

Email:

### Remarks:

1. This guarantee card should be kept by the user, no replacement if lost.
2. Most new carry a two-year manufacturer's warranty from the date of purchase. Further details, please read <https://www.ailunce.com/AfterSaleService/>
3. The user can get warranty and after-sales service as below:  
Contact the seller where you buy.  
Products Repaired by Our Local Repair Center
4. For warranty service, you will need to provide a receipt proof of purchase from the actual seller for verification.

### Exclusions from Warranty Coverage:

1. To any product damaged by accident.
2. 2. In the event of misuse or abuse of the product or as a result of unauthorized.

