

ACOM

OUTSTANDING HF POWER PRODUCTS



ACOM 2000A
Automatic
HF Linear Amplifier

User's Manual

Installation, Operation
and Maintenance

July 2020

This manual is for electronic distribution mainly.
If you have it on paper and you no longer need it, please, recycle it!

The latest versions of our User's Manuals are available at
www.acom-bg.com

ABOUT DOCUMENTATION

All ACOM documentation (including manuals, brochures, specifications, descriptions, presentations, video materials, etc.) are based on the latest available information at the time of creation of our documents.

As we always strive to constantly improve and update our products, ALL PRODUCTS, PRODUCT SPECIFICATIONS AND DATA ARE SUBJECT TO CHANGE. ACOM reserves the right to make changes and improvements at any time without further notice or obligation to notify any person or organization of such revisions or changes, made in order to improve the reliability, function, quality and design, and/or performance of the ACOM products and services.

Further, this User's Manual is provided AS IS and ACOM shall not be liable for possible errors contained herein.

This manual supersedes all previous editions, which thereby become invalid.
The cover images used in the manual are illustrative only.

We are continuously striving to improve our documentation, but nobody is perfect.
And our documentation is not an exception of this rule.
Have you found any errors or would you like to suggest changes in our documentation?
Please help us by sending your suggestions to the following e-mail address:
documentation@acom-bg.com

The latest versions of our User's Manuals are available at
www.acom-bg.com

We highly recommend you to use this manual in electronic form as PDF-file instead of printed version. The PDF-file is easy to read on any computer, tablet, smart phone or other similar device. In the PDF file you will find the necessary information very fast due to context-oriented links (marked in **orange**) inside the file, including context-linked Table of Content.

To open PDF-files you can use any free PDF viewer, for example:

- Adobe Acrobat Reader DC (<https://get.adobe.com/reader>);
- Foxit Reader (<https://www.foxitsoftware.com/pdf-reader>);
- Your web browser. Web browsers like Google Chrome, Firefox and Safari all have integrated PDF readers.

Title of Documentation ACOM 2000A Automatic HF Linear Amplifier
User's Manual
Installation, Operation and Maintenance

Type of Documentation User's Manual

Purpose of Documentation This manual explains Installation, Operation and Maintenance of the ACOM 2000A Automatic HF Linear Amplifier.

Record of Revisions	Description	Release Date	Notes
	ACOM 2000A User's Manual	18.11.2004	First edition
	ACOM 2000A User's Manual	15.09.2010	Second edition
	ACOM 2000A User's Manual	19.05.2017	Third edition
	ACOM 2000A User's Manual	14.07.2020	Fourth edition

Validity The specified data is for product description purposes only and may not be deemed to be guaranteed unless expressly confirmed in the contract. All rights are reserved with respect to the content of this manual and the availability of the product.

Copyrights © 2020 ACOM Ltd.
Copying this document, giving it to others and the use or communication of the contents thereof without express authority, are forbidden.
Offenders will be held liable for infringement of any intellectual property of ACOM Ltd. and all damages which may rise as a result.

Published by ACOM Ltd.
Bulgaria | Bozhurishte 2227
Sofia-Bozhurishte Economic Zone | 6 Valeri Petrov Str.
GPS coordinates: 42.748616° | 23.209801°
Web: www.acom-bg.com
E-mail: documentation@acom-bg.com

Note This manual has been printed on chlorine-free bleached paper.

Contents

ABOUT DOCUMENTATION	3
1. GENERAL INFORMATION	8
1.1. Introduction and Description	8
1.2. Owner Assistance	8
1.3. Equipment Supplied and Options.....	9
1.4. Features.....	9
1.5. Safety Considerations, Explicit Definitions.....	11
2. INSTALLATION.....	13
2.1. Unpacking and Initial Inspection	13
2.2. Line Voltage Selection	14
2.3. Transformer Installation.....	14
2.4. Connections.....	16
2.5. Installation of Optional Fan.....	21
3. POWER ON, RCU CONTROLS, INDICATORS AND MENUS	22
4. AUTO MODE	25
4.1. MAIN MENU	25
4.2. AUTO TUNE procedure.....	29
4.3. Erasing USER segments (return to DEFAULT- tunings)	33
5. MANUAL MODES	35
5.1. MANUAL TUNE	35
5.2. MEASURE function	36
5.3. SERVICE procedure.....	38
5.4. CAT SETTINGS	38
5.5. MORE SETTINGS	39
5.6. HELP.....	41
6. OFF MENU	42
6.1. CALL SIGN	42
6.2. AUTO ANTENNA CHANGE.....	42
6.3. AUTO OPERATE.....	42
6.4. SELF ADDRESS.....	43

- 6.5. CLEAR THE USER TUNINGS 43
- 6.6. CLEAR THE MEMORY 43
- 7. CAT OPERATION AND CONNECTIONS..... 45
- 8. MAINTENANCE 49
 - 8.1. Cleaning..... 49
 - 8.2. Backup Battery Replacement 49
 - 8.3. Fuse Replacement 49
 - 8.4. Tube Replacement..... 50
 - 8.5. The ACOM 2000A Simplified Schematic Diagram 50
 - 8.6. Troubleshooting 53
- 9. SPECIFICATIONS..... 56
 - 9.1. Parameters 56
 - 9.2. Functions 57
 - 9.3. Storage and Shipment..... 58
- 10. BRIEF MENU GUIDE 59
- NOTES 60

Figures

- Figure 2-1 Transformer Installation..... 15
- Figure 2-2 Amplifier Main Unit Connections 16
- Figure 2-3 Amplifier Remote Control Unit Connections..... 17
- Figure 2-4 Main Unit, RCU, Antenna Selector and Transceiver connections 17
- Figure 3-1 Remote Control Unit (RCU) 22
- Figure 3-2 Menu Structure (see also Section 10) 23
- Figure 3-3 RCU display - OFF MENU 24
- Figure 4-1 RCU display during warm-up..... 25
- Figure 4-2 RCU display - MAIN MENU 26
- Figure 4-3 RCU display Main Menu during transmission 28
- Figure 4-4 RCU display - AUTO TUNE..... 31
- Figure 4-5 RCU display - end of AUTO TUNE 32
- Figure 4-6 RCU display – AUTO TUNE fail..... 33

Figure 5-1 RCU display - MANUAL MODE.....	35
Figure 5-2 RCU display - MANUAL TUNE	36
Figure 5-3 RCU display - MEASURE.....	37
Figure 5-4 RCU display - SERVICE.....	38
Figure 5-5 RCU display – CAT SETTINGS	39
Figure 5-6 RCU display – MORE SETTINGS	39
Figure 5-7 RCU display – MORE SETTINGS – ANTENNAS.....	41
Figure 7-1 CAT Connector pin-out front view	45
Figure 7-2 CAT Connection by RS-232 Y cable.....	46
Figure 7-3 CAT Connection to ICOM CI-V interface.....	46
Figure 7-4 CAT Connection to KENWOOD RS-232 interface	47
Figure 7-5 CAT Connection to KENWOOD TTL interface	47
Figure 7-6 CAT Connection to Elecraft K3.....	47
Figure 7-7 CAT Connection to Yaesu transceiver with RS-232 interface.....	48
Figure 7-8 CAT Connection to YAESU FT-1000D.....	48
Figure 7-9 CAT Connection to YAESU FT-897	48
Figure 8-1 ACOM 2000A Simplified Schematic Diagram	52

Tables

Table 2-1 ACOM 2000A Individual Data	13
Table 8-1 Troubleshooting, Error messages.....	55

1. GENERAL INFORMATION

Congratulations on purchasing one of the finest HF amplifiers in the world today.

ACOM is pleased that you have chosen one of our products, and we will endeavor to provide you with the information and support you need to enjoy your purchase for many years.

We urge you to read all of the following materials before you embark on operating your new amplifier.

1.1. Introduction and Description

This manual explains:

- Installation
- Operation and
- Maintenance

of the ACOM 2000A automatic HF linear amplifier.

The ACOM 2000A is a complete and self-contained linear amplifier that covers all amateur bands from 1.8 through 30MHz, has automatic self-tune capability, and provides up to 1500W output power with less than 60W exciter drive. The amplifier can tolerate loads up to 3:1 VSWR (2:1 on 160 meters) and the process of matching the antenna impedance to the optimum load of the tubes is automated. It features a Remote Control Unit (RCU), contains nonvolatile memory for settings on up to ten different antennas per frequency segment, and offers command capability for use with an external automatic antenna selector and/or automatic antenna tuner. Transmit/receive switching is capable of full break-in operation (QSK) via an internal vacuum relay.

All indicators and controls (except the primary mains switch and indicator) are available via the Remote Control Unit - RCU. All command input to the RCU is menu-driven.

1.2. Owner Assistance

If assistance is needed, you should contact your local dealer first. If necessary, your dealer will contact ACOM for additional guidance.

If you still have an issue you need to discuss with one of ACOM's specialists, the contact information is as follows:

ACOM Ltd.

E-mail: support@acom-bg.com

Bulgaria | Bozhurishte 2227

Sofia-Bozhurishte Economic Zone | 6 Valeri Petrov Str.

GPS coordinates: 42.748616° | 23.209801°

1.3. Equipment Supplied and Options

The ACOM 2000A amplifier is shipped in two cardboard cartons. One carton contains the power transformer and the second carton contains the amplifier. The remote control unit (RCU) is shipped inside the amplifier in the area where the power transformer will be mounted.

There are several individual purchase options available. They are:

- An auxiliary EXTERNAL FAN for continuous modes of operation (rear panel mount);
- CAT CABLES for connection to the supported transceivers.



NOTE

The Technical Supplement to this User's Manual is available from ACOM or from your dealer on request.

The Technical Supplement containing electrical diagrams, technical details on operation and maintenance, as well as a list of command set and local network rules for RS232 operation.

The Automatic antenna selector ACOM 2000S and Remote antenna switch ACOM 2000SW are especially designed to complete your ACOM system.

1.4. Features

- Automated matching of the antenna impedance to the optimum load of the tubes during initial preparation of user tunings.
- Easy to operate. No operator intervention is required when changing antennas or frequency. Thus, the risk of inadvertent errors, such as incorrect antenna selection or failure to change band switch, is eliminated.
- TFT color display. All amplifier status indicators and comments are presented on the Remote Control Unit (RCU) display. The HELP sub-menu gives on-board technical assistance and troubleshooting suggestions, power-on elapsed time hours etc. Two color strips display peak forward and reflected power. Indicators are provided for OPERATE/STANDBY and for fault conditions.
- Easy maintenance. Information on the amplifier's internal status is stored in an "INFO BOX" for the 12 most recent protection faults. This information can be read directly from RCU display by the operator.
- Less QRM, improved Electro Magnetic Compatibility during tuning. Retuning can be achieved in three ways: manually via the RCU, by the transceiver's CAT system, or with a very short transmission - a single word on SSB or a dot (even at 40 wpm) on the new frequency is enough to change bands or segments automatically in a second. Also, the initial process of user tuning settings preparation is done in less than three seconds at a quarter of nominal output power.

- Saves space on the operating table. Since the amplifier is controlled by the RCU, the main unit can be located up to 20 meters (65 feet) from the operating position. The supplied 3 meters (10 ft) cable may be easily extended to the needed length.
- Operates automatically without special signals from the transceiver - "ground on TX" (PTT) and 60W RF drive power are sufficient to control and operate the amplifier.
- CAT connection to most transceiver models.
- Broadband input matching circuit resulting in very good load to the transceiver over the entire short-wave spectrum.
- Uses two 4CX800A (GU74B / ГY74Б) Svetlana (Светлана) high performance ceramic-metal tetrodes with plate dissipation of 800W each (forced air cooling, grid-driven).
- ACOM maintains strict adherence to the tube manufacturer's specifications for cooling and for the sequence of applying and removing the different tube voltages. Starting filament current is limited, and there is constant monitoring and protection of all supply voltages and currents. The Bias Optimizer decreases the heat dissipated from the tubes, and there is automatic protection against overheating or insufficient air flow.
- A novel and innovative output RF Arc protection is employed. It safeguards the amplifier, antenna, antenna selector and tuner against severe damage in case of possible break down.
- High voltage power supply inrush current protection which eliminates the danger of affecting sensitive devices, connected to the same mains circuit. The amplifier can be configured for 5 nominal line voltages: 100, 120, 200, 220 and 240VAC (50 or 60Hz). Other nominal values possible on request.
- Continuous measuring and/or monitoring of 20 most important parameters of the amplifier, exciter and antennas via RCU and computer as described in the Technical Supplement.
- All functions are accessible from a computer via RS232 serial port connection. Also, local networking capability exists for more than one set of amplifier / antenna units working in a system.

1.5. Safety Considerations, Explicit Definitions

The ACOM 2000A Automatic HF Linear Amplifier is a Safety Class I unit, i.e. the third grounding lead of its mains cord (which is colored yellow with two green stripes) and the ground stud on the rear panel of the amplifier, marked GND, both must be connected to the station's grounding system for safe operation. The amplifier is designed to meet international safety standards and complies with CE safety and electromagnetic compatibility requirements, as well as FCC regulations.

This User's Manual contains information, precautions and indications for cautions and warnings which must be followed by the user to ensure safe operation and to keep the ACOM 2000A in safe operating condition.

The EXPLICIT DEFINITIONS described below apply to this operating manual:



DANGER

These notes call attention to a procedure which, if not correctly performed, could result in serious personal injuries and even death, fire hazard, electric shock and/or in substantial material damage.



WARNING

These notes call attention to a procedure which, if not correctly performed, could result in injuries and equipment damage, not only in the ACOM products, but also to other systems.



NOTE

These notes call attention to technical tips, as well as to important information for better understanding of ACOM products.

ORANGE TEXT as LINKS

marks all internal links in the document between Sections, Figure, Tables, etc. for your convenience.

PRECAUTIONS:



DANGER! HIGH VOLTAGE!

The amplifier works with high voltages up to 3000V, which are LETHAL!

For your safety, pull the amplifier power plug out of the mains wall outlet and WAIT AT LEAST 30 minutes EACH TIME BEFORE you remove the cover of the amplifier. Do not touch any part inside while the amplifier is open because some residual voltages may still be present.



DANGER! HIGH VOLTAGE!

Never allow anyone, ESPECIALLY CHILDREN, to push anything into holes in the case - this will cause electric shock. NEVER TOUCH AN ANTENNA during transmission - this may result in an electric shock or burn. NEVER EXPOSE the amplifier to rain, snow or any liquids. AVOID placing the amplifier in excessively dusty environments or in direct sunlight. DO NOT OBSTRUCT AIR INTAKE (rear panel) and EXHAUST (top cover) areas of the amplifier. Keep a minimum distance of 10cm (4 inches) to the intake and 50cm (20 inches) to the exhaust.



DANGER

Do not undertake on your own repairs or changes in hardware or software of the amplifier in order not to endanger your or other's health and life and not to damage the amplifier and the equipment connected with it, not covered by warranty. The manufacturer is not liable for another's actions and responsibility shall be assumed by the doer.



WARNING

To avoid damage (not covered under warranty) read the Section **2 INSTALLATION** of this User's manual carefully. If you have any doubts about the installation, operation or safety of the amplifier, please consult your dealer.

2. INSTALLATION

2.1. Unpacking and Initial Inspection



NOTE

Before you install your amplifier, thoroughly read this manual. First, carefully inspect the both cardboard cartons and its contents for physical damage. ACOM ships amplifiers in highly protected containers, but it cannot assure that mistreatment by shippers will not occur. If damage is evident, notify your dealer immediately. Delay may void the carrier's warranty. Keep all packing for possible future transportation!

In order to take the RCU out of the amplifier, remove the cover by removing all screws except the eight located in the tube exhaust areas. Remove the plastic tubes holders but keep them for possible future transportation. Do not remove the silicone rubber chimneys!



WARNING

Check the HV Crowbar (see [Figure 2-1 Transformer Installation](#)) - it must reliably short the HV lead to the chassis when the cover is removed.

Take the RCU out and free the compartment for installing the transformer. Carefully inspect the RCU and the amplifier main components for any possible shipping damage.



NOTE

Check carefully the serial numbers of amplifier and tubes with the Table of Individual Data (see [Table 2-1 ACOM 2000A Individual Data](#)). If you find any discrepancies, notify your dealer immediately to have your warranty information corrected.

AMP SN:	
Front tube SN:	
Rear tube SN:	
Voltage Selector Position	VAC
Optional Fan Output Voltage	VDC

Table 2-1 ACOM 2000A Individual Data

2.2. Line Voltage Selection



WARNING

To avoid damage (not covered under warranty), verify that the voltage for which the amplifier is set corresponds to your mains nominal voltage. Most 120V and especially 100V domestic mains installations may not withstand the current consumption and you will have to reduce the output power to about 1000W PEP. In USA, 240V is strongly recommended.

Normally the amplifier is supplied with Voltage Selector set for a nominal mains voltage of 240V. There might be exceptions in cases of special delivery and then the voltage set is noted in the Table of Individual Data (see [Table 2-1 ACOM 2000A Individual Data](#)). If your mains has a different nominal voltage, it will be necessary for you to contact your dealer or see the Technical Supplement for details.

2.3. Transformer Installation



NOTE

After installing the transformer, the weight of the unit is about 35kg (78 lbs.), which should preferably be handled by two persons. An assistant may be needed to hold the amplifier steady during transformer installation.

Position the amplifier, with the transformer not yet installed, flat on a table near the place where it will be used. During the process described below, when the amplifier cover is removed, take care not to torque or twist the chassis nor let the amplifier stand on edge. Do not lift the unit by only one corner.

Orient the amplifier on the table so that the transformer compartment is in front of you (see [Figure 2-1 Transformer Installation](#)).

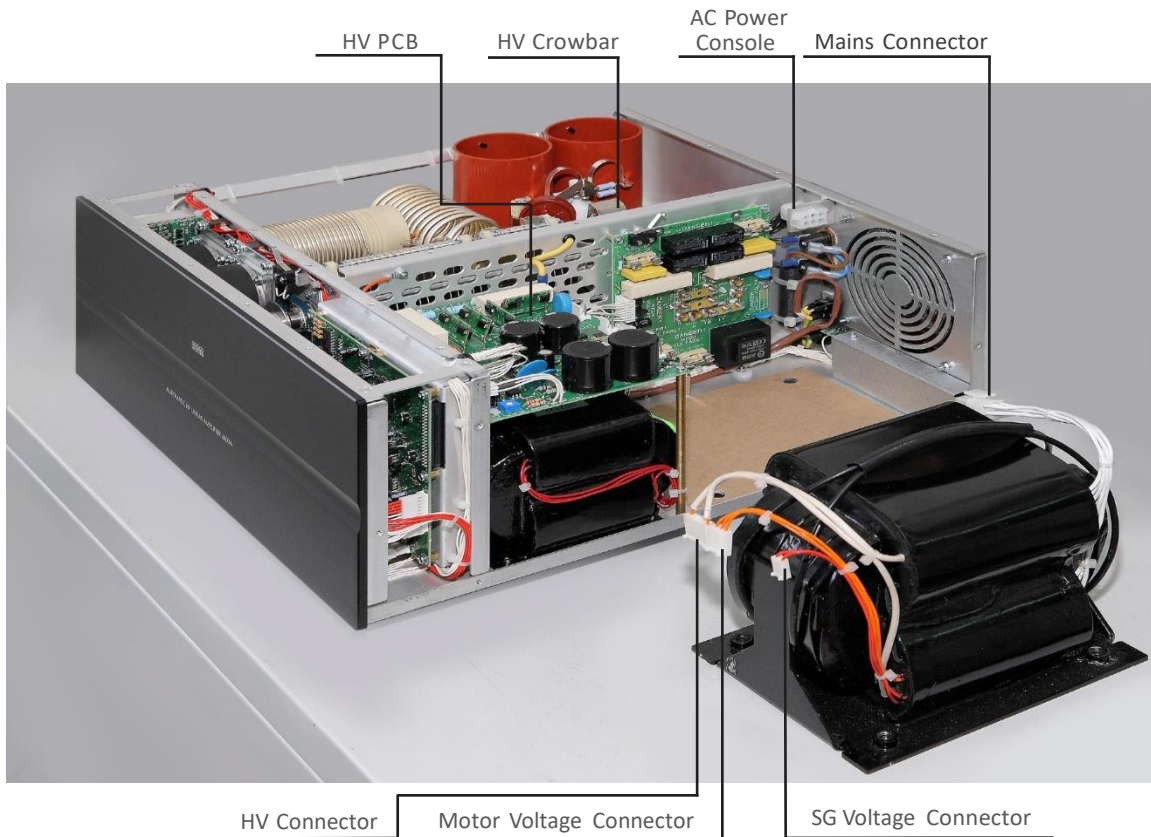

Figure 2-1 Transformer Installation

Take the transformer out of the carton and remove the shipping board but do not discard the shipping board or the bolts. For transformer mounting, four shorter bolts (M8x16mm) are provided in a polyethylene envelope inside the same carton. Use the polyethylene envelope to store the longer shipping bolts. Keep the board together with the four long bolts and all packing for possible future transportation of the transformer.

Move the transformer, using its rope sling handle, into the compartment. Take care not to damage the wiring or components and position the transformer so that the captive nuts are aligned with the corresponding chassis holes. Make sure that the transformer is centered. The transformer bolts must be installed NOW for safe operation.

Holding its two sides (front and back) simultaneously, pull the amplifier towards you just far enough that the two outside transformer captive nuts appear off the table edge. Support the amplifier until your assistant loosely screws in the two outside transformer-mounting bolts. Pull the amplifier a further 12-13cm (about 5 inches) until the other two captive nuts appear off the table edge. Keep supporting the amplifier until your assistant loosely screws them in. After checking that the transformer is centered, tighten all 4 bolts. Now move the amplifier back over the table.

The transformer's Mains Connector plugs into the AC power console (see **Figure 2-1 Transformer Installation**). The other three connectors (HV, Motors Voltage & Screen Grid Voltage) plug into the HIGH VOLTAGE PCB, clearly seen on top.

Replace the cover and carefully reinstall all screws.

2.4. Connections

The amplifier is now ready to be connected to your station. Connection must be accomplished in the order described below, before you apply mains voltage to the amplifier.



WARNING

Have in mind that the grounding system may have to withstand currents over 20A with insignificant voltage drop on it. Therefore, it may be necessary to improve it considerably (to become lower-resistive, i.e. with heavier leads and lower-resistive ground path). The grounding leads should be at least 8mm² (AWG 8 or SWG 10).

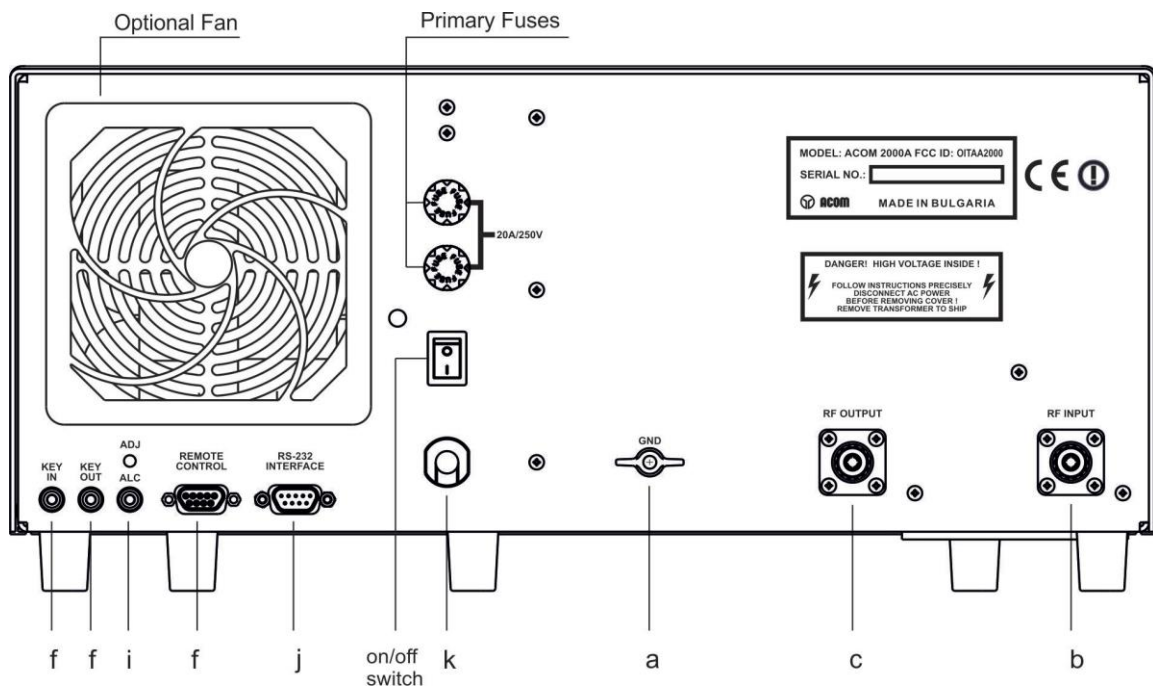

Figure 2-2 Amplifier Main Unit Connections

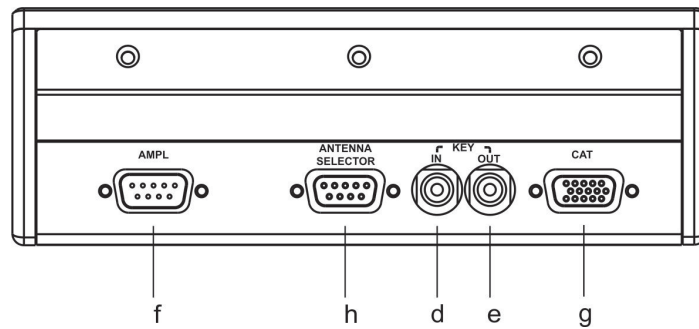

Figure 2-3 Amplifier Remote Control Unit Connections

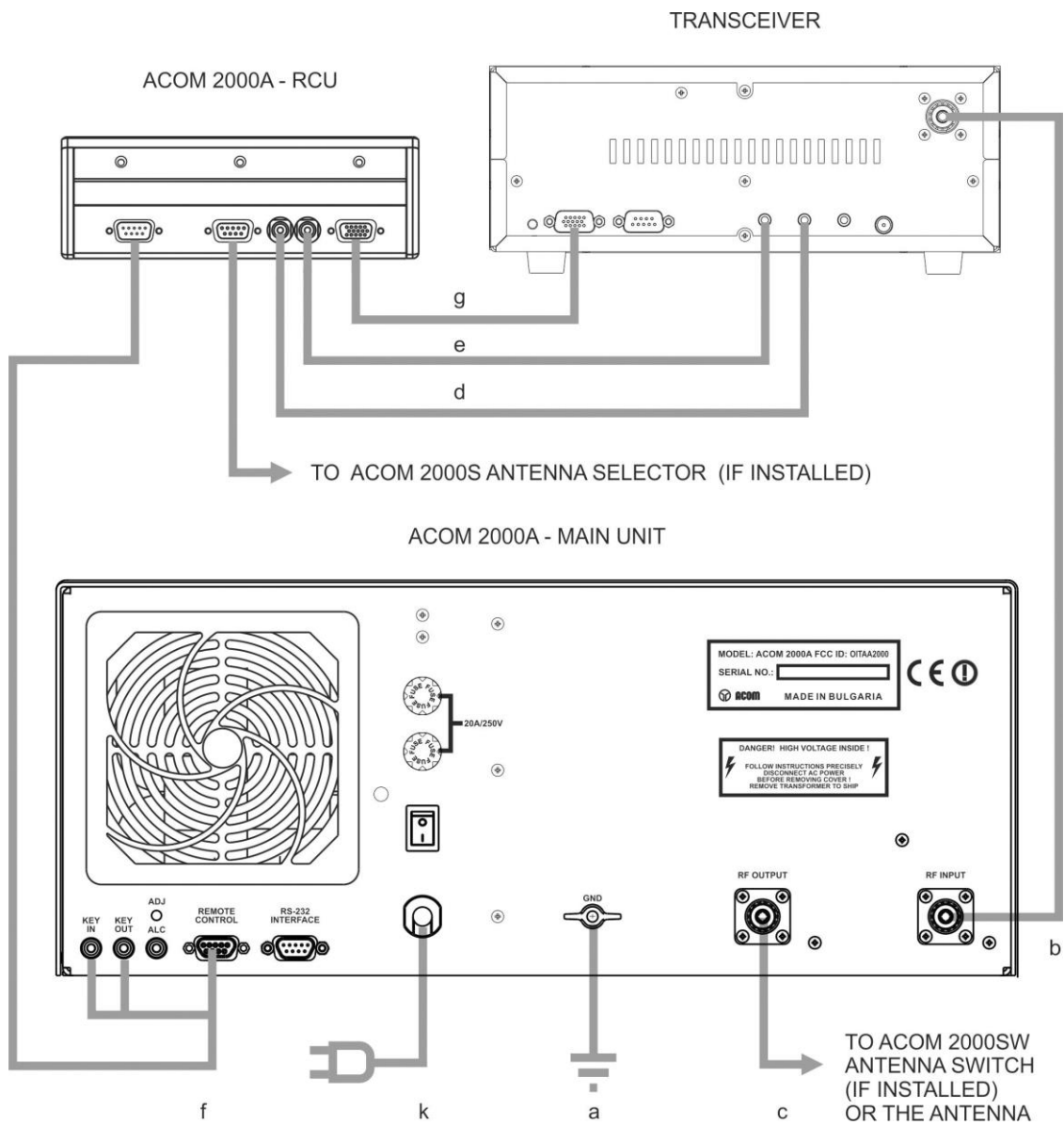

Figure 2-4 Main Unit, RCU, Antenna Selector and Transceiver connections

- a) Connect the ground stud of the amplifier Main Unit (on the rear panel, marked GND) to the station's grounding system (see *Figure 2-2 Amplifier Main Unit Connections*, *Figure 2-3 Amplifier Remote Control Unit Connections* and *Figure 2-4 Main Unit, RCU, Antenna Selector and Transceiver connections*).
- b) Connect a coaxial cable with a PL-259 plug from the transceiver output to the amplifier rear panel RF INPUT socket.

**WARNING**

If this is the first time you will use a high-power amplifier in your station, pay attention to the coaxial cable type from the amplifier's output. It must handle the increased power safely - particularly on the higher frequency bands. We recommend you use RG213 or better coaxial cable. Similar good quality coaxial cable should be used throughout your antenna system. Check the power capability of the antenna selector, the tuner and the antenna itself (especially multiband trap antennas).

**WARNING**

Do not use your transceiver's internal tuner with the 2000A – this can damage the input of the ACOM 2000A.

- c) Connect a coaxial cable from the amplifier output (on the rear panel, marked RF OUTPUT) with a PL-259 plug to the antenna selector or tuner or to the antenna for the respective band.

**NOTE**

Your amplifier will not work if KEY-IN is not connected properly.

Transceiver producers give different names to this output and they are for instance TX-GND, SEND, T/R-LINE, etc. Some transceivers require that ground on transmit is implemented via a software command, or by changing the setting of a switch on the rear panel, or interior of the transceiver. Check your transceiver's manual.

- d) Run a cable terminated in a RCA phono plug from the transceiver socket providing ground on transmit to the RCU rear panel KEY-IN socket.

**NOTE**

If there is a CAT connection between your amplifier and your transceiver, which carries also the KEY-IN signal, you don't need a separate KEY-IN cable. Not all transceivers however have this capability. Please, see Section **7 CAT OPERATION AND CONNECTIONS** for more details.

- e) The KEY-OUT socket on the RCU rear panel provides an extra control signal from the amplifier to the transceiver. It could be used to improve the transmit/receive switching.

If your transceiver has a suitable input that disables transmission, we recommend that you connect it with a cable terminated in a Phono connector to the KEY-OUT socket of the RCU. Transceiver producers give different names to this input and they are for instance TX-INHIBIT, MUTE, LINEAR, etc. Check your transceiver's manual. Consult your dealer or see the Technical Supplement for details.

If your transceiver has not such an input don't worry - the amplifier will function normally as well and then the KEY-OUT may remain unused.

**NOTE**

If there is a CAT connection between your amplifier and your transceiver, which carries also the KEY-OUT signal, you don't need a separate KEY-OUT cable. Please, see Section **7 CAT OPERATION AND CONNECTIONS**.

- f) Connect the supplied DB9 / DB9+2RCA control cable between the RCU connector marked AMPL and the amplifier REMOTE CONTROL connector. Plug in the two Phono connectors marked KEY-IN and KEY-OUT to the respective amplifier sockets. Screw in the knurled screws.
- g) To control the amplifier via CAT you will need a special cable from the transceiver to the High-Density HD-15 connector on the RCU rear panel, marked CAT. The HD-15 pinout and cable diagrams for various transceivers are shown in Section **7 CAT OPERATION AND CONNECTIONS**. The cable can be supplied as an option with the amplifier or purchased separately or you can assemble your own. Check with your dealer for cable options for your transceiver.
- h) Automatic antenna selector ACOM 2000S can be connected to the respective connector on the RCU rear panel.
- i) The ALC output of the amplifier normally remains unused. In case of need of ALC for your transceiver, which we do not recommend, you may contact your dealer or see the Technical Supplement.
- j) The connector on the amplifier rear panel, marked RS232 INTERFACE, remains unused until you decide to use the amplifier with a computer or in a local network as described in the Technical Supplement.

**W A R N I N G**

Do not connect to the connector, marked RS-232 a standard cable because this may result in damage in both - amplifier or connected equipment. In order to use the RS-232 interface, a special cable must be prepared. Contact your dealer or see Technical Supplement for details.

- k) Mains plug and fuses.

**W A R N I N G**

If your amplifier is only fitted with one mains fuse, it is suitable for 0-220/240 VAC electricity supplies ONLY (these supplies are standard in the European Community). Your dealer will check that your amplifier is correctly fused before it is shipped to you. Customers should check with a qualified electrician if the amplifier is to be used outside the country in which it was purchased.

Due to the different standards in different countries, the mains plug is supplied and mounted by the dealer. He connects to the mains cord end a standard mains plug which meets the Safety Class I units standard in your country. The ground lead of the amplifier's mains cord is colored yellow with two green stripes and the blue and brown leads are active. When the amplifier is to be used with only one mains fuse, it is connected in series with the brown lead which must be the active. If you have any doubts about the correct way of connecting the wires, consult your dealer. All amplifiers sold in the USA will have two fused leads.

- l) Preparation of wall outlet for the amplifier.

**W A R N I N G**

Before connecting the amplifier to your mains supply, be sure that the supply is correctly wired, and is adequate for the current drawn by the amplifier. Make certain that the grounding lead is connected properly in the wall outlet for the amplifier.

It is preferable that you use the wall outlet closest to the source. The installation leads should be at least 2.5mm² (AWG 12 or SWG 15). Check if the respective fuses can handle current up to 20A, as well as if the voltage corresponds to the voltage for which the amplifier is set (see Section [2.2 Line Voltage Selection](#)). If you connect the amplifier to a different mains outlet, be sure that you check it, too.

Make sure the main Power Switch on the front panel is in OFF position (so that the red strip on the switch is hidden) and insert amplifier's mains plug into the wall outlet prepared for it. The amplifier remains switched off.

2.5. Installation of Optional Fan

This fan is not necessary in SSB and CW modes, nor in continuous carrier modes (RTTY, SSTV etc.) with carrier down times of maximum 15 minutes and a subsequent pause of 3 minutes. For higher duties the fan is recommended. The auxiliary fan (119x119mm) is supplied as an option with a set of 8 screws, nuts and washers. It may be mounted by the manufacturer or dealer on request (see [Figure 2-2 Amplifier Main Unit Connections](#)). Contact your dealer or see the Technical Supplement for details.

3. POWER ON, RCU CONTROLS, INDICATORS AND MENUS



DANGER

Do not turn the amplifier on for at least 2 hours after unpacking it in the room where it will be used. Pay particular attention when you move it from a very cold into a warm place - condensation is likely and this could result in damage to the high voltage circuits. In such a case, wait at least 4 hours. A similar effect can occur after a rapid warming of the operating room (for instance after switching on a powerful heater in a cold shack).



WARNING

To avoid damage (not covered under warranty) carefully check that the voltage for which the amplifier is set corresponds to your mains nominal voltage (see Section 2.2 *Line Voltage Selection* and *Table 2-1 ACOM 2000A Individual Data*).

After following all instructions in Section 2 *INSTALLATION*, you can turn ON the Main power switch on the rear panel (see *Figure 2-2 Amplifier Main Unit Connections*). The front-panel red indicator must light and a picture will appear on the RCU (see *Figure 3-1 Remote Control Unit (RCU)*):

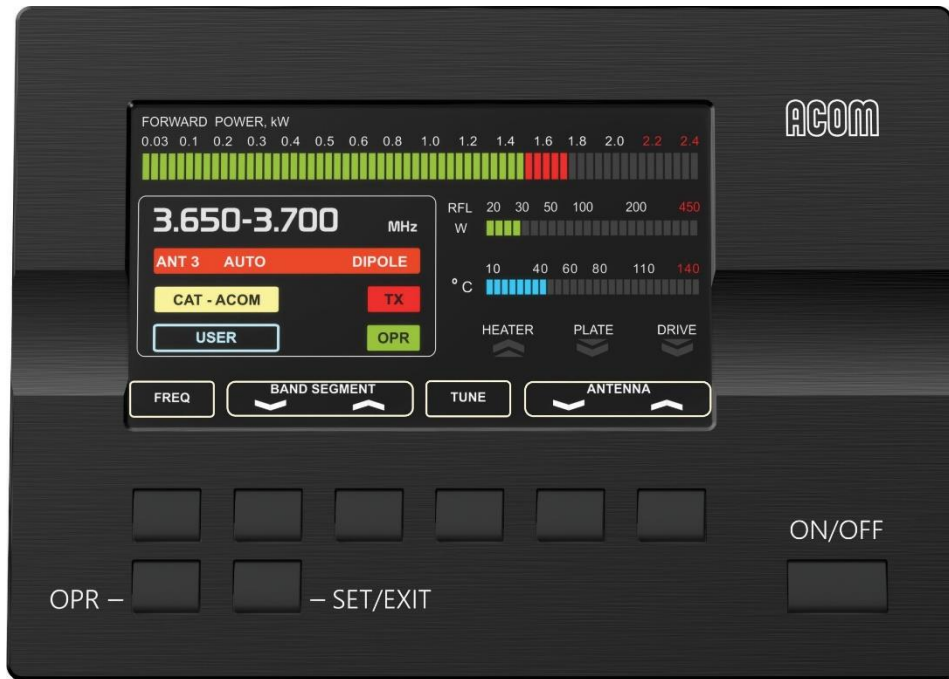

Figure 3-1 Remote Control Unit (RCU)



NOTE

The owner's callsign will be only displayed after it has been programmed into the RCU. See Section **6.1 CALL SIGN** for details on programming your callsign.

In this condition, only the RCU is operational, while the amplifier itself is still fully off. Nevertheless, you have access to the HELP feature (at the left bottom corner, see Section **5.6 HELP**) and you can switch antennas if the ACOM 2000S automatic antenna selector and the ACOM 2000SW remote antenna switch are installed. The assigned number and name of the currently used antenna is shown at the right bottom corner of the display, just above the antenna-change key.

Except for the main power switch on the rear panel, the amplifier is controlled via the RCU (see **Figure 3-1 Remote Control Unit (RCU)**). The amplifier is toggled ON or OFF by pressing the ON/OFF button. There are two more fixed function buttons located at the left bottom – the OPR button which is used to toggle between OPERATE and STANDBY (STB) modes, and the SET/EXIT button - to enter and exit the menus.

The six buttons immediately below the bottom of the display are soft keys and their function can vary depending on what the context is at the time. As you explore the various functions of the amplifier, the functions of these buttons are explained in detail.

The control of the amplifier is structured in two menus - OFF and MAIN, each having several sub-menus (see **Figure 3-2 Menu Structure (see also Section 10)**):

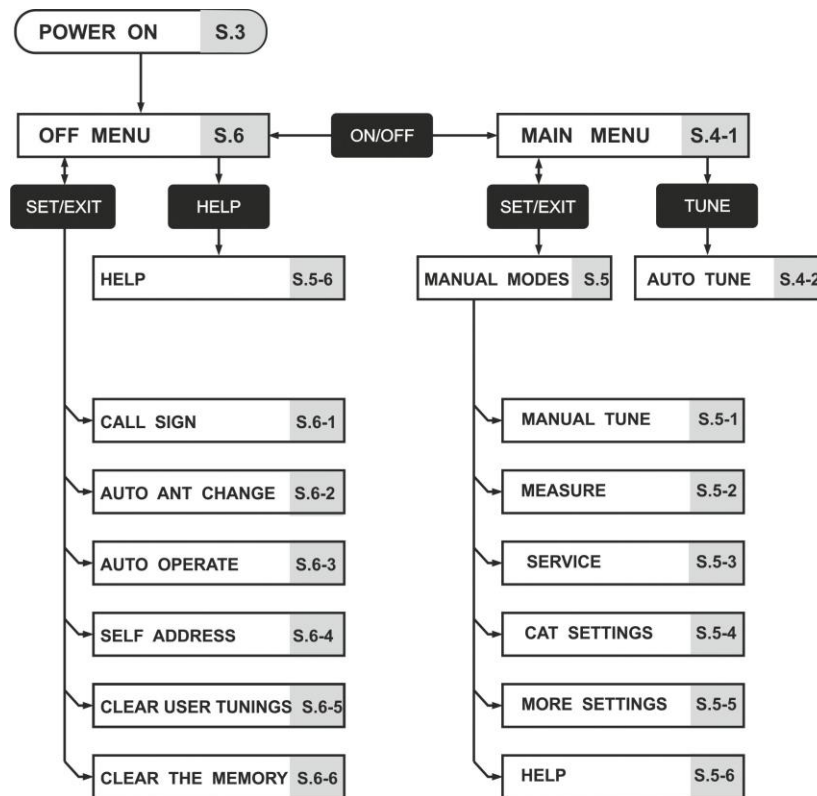

Figure 3-2 Menu Structure (see also Section 10)



NOTE

We recommend that before powering up the amplifier for the first time, you familiarize yourself with the functions of the RCU in the OFF menu. The available controls and indications seen on the RCU are similar in both the OFF and MAIN menus.

You can proceed in one of two directions:

- a) You can enter the OFF menu (see below) or:
- b) You can turn on the amplifier and begin the warm-up sequence. After 2.5 minutes you will enter the MAIN menu (see Section **4.1 MAIN MENU**) and may start operating the amplifier.

The OFF-menu (see Section **6 OFF MENU** also) can be reached by pressing the SET/EXIT button:

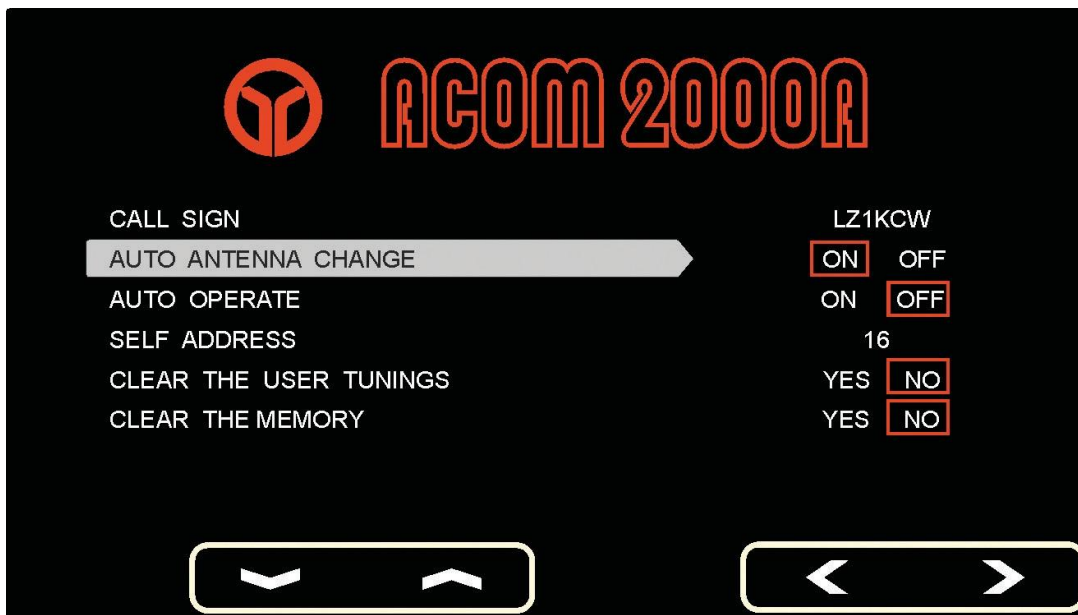

Figure 3-3 RCU display - OFF MENU

By means of the UP and DOWN keys you can select one of the listed items. Then with the left and right arrow buttons you choose the desired value or move the colored frame on it.

The call sign character positions are selected by left and right arrow buttons. The character in a selected position is changed by means of the UP and DOWN keys. Push the left button repeatedly to return to the items list.

To exit the OFF menu, press the SET/EXIT button again.

The purpose and use of the OFF menu settings are described in detail in Section **6 OFF MENU**, after the description of the basic functions and use of the amplifier.

4. AUTO MODE

Operation of ACOM 2000A amplifier is simplified a great deal due to the high degree of automation. You can start operation immediately after it is installed. However, to make full use of its possibilities and to fully configure the amplifier we recommend that you thoroughly read the following information.

4.1. MAIN MENU

a) TURNING ON

In order to turn on the amplifier, while the rear panel Switch (see [Figure 2-2 Amplifier Main Unit Connections](#)) is on, press the ON/OFF button on the RCU and hold it on for about one second and you will hear TEST being sent in CW.

After successfully passing the INITIAL SELFTEST, the following display appears:



Figure 4-1 RCU display during warm-up

A 2.5 minutes tube warm-up period follows during which heater and bias voltages are applied. During warm-up the amplifier remains in STB, so you can operate with the transceiver only. You can also change the antennas manually or read the HELP texts during the warm-up period.



NOTE

When you intend to have a brief pause in operating (e.g. less than 30 minutes), it is better to leave the amplifier in STB mode instead of turning it off. Tube life may be shortened by repeatedly turning on and off the tube heater supply. If you are concerned about this, discuss it with your dealer.



NOTE

However, if you unintentionally power-off the amplifier, it is best to switch it on again immediately. When the pause is short (up to one minute) and the cathodes are still warm, the warm-up period is shortened significantly, which reduces the waiting time and prolongs the tube's expected life.

b) MAIN MENU

After the indicated warming up period expires, all voltages are automatically applied to the tubes in the correct sequence. At the same time the stepper motors perform a self-test and finally tune the plate circuit to the frequency segment on which the amplifier was last used. You hear R being sent in CW and the MAIN MENU appears on the TFT display (see *Figure 4-2 RCU display - MAIN MENU*)



Figure 4-2 RCU display - MAIN MENU

The RCU display provides information about the current operational condition of the amplifier. You can see three bar graphs: Forward Power, Reflected Power (RFL) and Exhaust Air Temperature. Unless transmitting, only the last one is active, indicating the Exhaust Air temperature in degrees Celsius.

The whole HF spectrum is divided into 250 segments. Segment width increases with frequency from 25kHz on 160m to 300kHz on 10m. You can use up to ten different antennas and tunings per segment. This may be useful with narrow-bandwidth antennas.

The frequency segment on which the amplifier is tuned (in MHz) is indicated on the left-hand side on the display (28.300 to 28.600 in **Figure 4-2 RCU display - MAIN MENU**).

Below the frequency segment, the number of the antenna in use is displayed along with its name, and how the antenna was selected – manual or auto.

If the CAT connection to the transceiver is turned on, the transceiver type is shown at the left side under the antenna field.

At the bottom left it is shown the tune type for the current frequency segment and antenna (see **Figure 4-2 RCU display - MAIN MENU**, DEFAULT is shown indicating as factory programmed). The amplifier may also be user-tuned by means of the AUTO TUNE procedure as explained in Section **4.2 AUTO TUNE procedure**.

Next to the tune type there is an indication for operate (OPR) or Standby (STB) mode.

At the bottom right there are three indicators available which warn you with yellow light when the heater voltage, the plate current, or the drive RF power are approaching their limits.

c) ON AIR

If the VSWR of the antenna is acceptable (below 1.5:1) or you have fresh USER TUNINGS readily prepared (see Section **4.2 AUTO TUNE procedure**), you may start operating the amplifier immediately after pressing the OPR (Operate) button. The label STB on the display changes to OPR and you may transmit. The bar graph on the upper line indicates the power fed into the antenna (forward power) and the smaller bar graph below - the power reflected from the antenna (RFL). The difference between the two is the real output power delivered from the amplifier. The red TX sign illuminates (See **Figure 4-3 RCU display Main Menu during transmission**) whenever KEY-IN input is keyed, i.e. the transceiver goes into transmit mode.

If the CAT connection is active and the amplifier is in OPERATE mode, it will continuously track the transceiver frequency and will automatically tune up when entering a new segment.

If there is no active CAT connection to the transceiver, and you start transmitting on a frequency different from the indicated segment (and the amplifier is in OPERATE mode), it automatically senses your operating frequency, selects the corresponding segment, and tunes up on it. This retuning takes less than one second and you are immediately ready to operate on the new band.

Example:

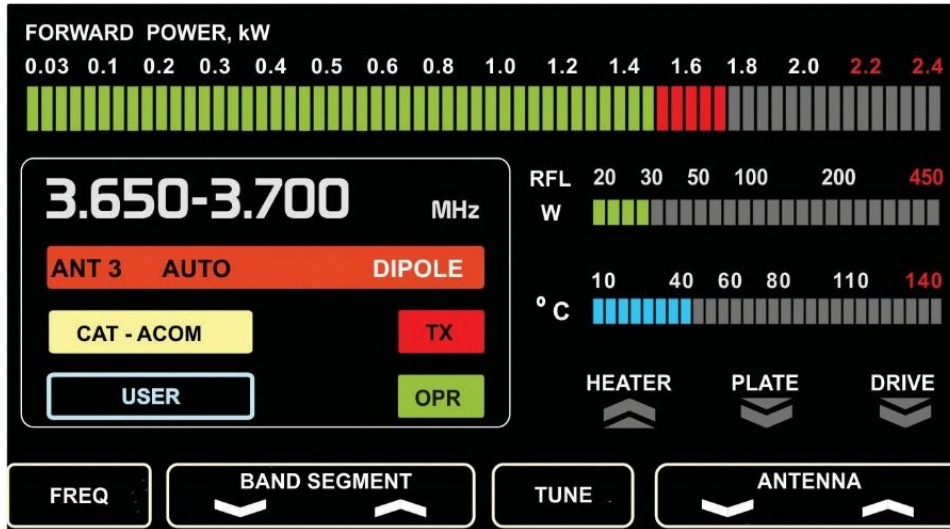

Figure 4-3 RCU display Main Menu during transmission

In the example, a signal frequency between 3650 and 3700kHz was applied and antenna Nr. 3 (named DIPOLE) was last used there with tuning done by the user.



NOTE

If in the OFF-menu (see Section 6.2 AUTO ANTENNA CHANGE) AUTO ANTENNA CHANGE is set to OFF, then the antenna number would not change.

A new frequency segment can be selected in these ways:

- As mentioned above, by the CAT system;
- By the internal frequency counter, after a short duration transmission from the transceiver (with the amplifier in OPR mode) - a single word in SSB or a dot in CW (even at 40 wpm) would be enough;
- Manually, in the MAIN-menu by selecting the desired segment by means of the BAND SEGMENT up and down buttons;
- You can select the automatic segment change mode by means of the CAT (FREQ) leftmost button.

d) A NEW ANTENNA

A new antenna can be selected while in the MAIN-menu by the means of the ANTENNA up or down buttons. If you don't have the Automatic antenna selector ACOM 2000S (and ACOM 2000SW remote antenna switch) installed, pushing these buttons would change only the settings stored in the amplifier memory for each antenna.

e) TURNING OFF

In order to turn the amplifier off, press the red ON/OFF button on the RCU. If you are not going to use the amplifier for a long time (more than 30 minutes), it is best to turn off the amplifier using the rear panel switch (see [Figure 2-2 Amplifier Main Unit Connections](#)) as well.

4.2. AUTO TUNE procedure

a) Let us examine the difference between the two types: DEFAULT- and USER- tunings.

DEFAULT tuning settings are permanently available in your amplifier memory. They are normally used when the load VSWR at the input end of the feed line is very low.

Real loads often have VSWR greater than 1.5:1, which usually requires the use of an outboard antenna tuner. Your amplifier will perform adequately with up to a VSWR 3:1, or up to 2:1 on 160m if you prepare USER tunings. This is a fully automatic procedure of matching the real load impedance to the optimum tubes load.



NOTE

This is NOT equivalent to using an external antenna tuner and does not change the SWR your transceiver will see when the amplifier is in STB mode.

User tuning settings are memorized and stored in a nonvolatile memory. They will be retrieved automatically each time you change the operating frequency or antenna number as described in the previous section. This may enable you to use the amplifier without an outboard antenna tuner over a wider frequency range and to change frequencies and antennas faster than would otherwise be possible with other amplifiers.

The amplifier is capable of memorizing up to 10 different antenna tunings for each frequency segment, irrespective whether they are for different antennas or for different environment conditions (for example wet and dry weather on the same antenna).



NOTE

REFLECTED POWER readings and the measured VSWR depend on the load impedance only and not on the amplifier tuning. If the impedance is different from the nominal (50 Ohm pure resistive), the REFLECTED POWER bar-graph will always indicate the reflected power presence (even at actual USR-tuning). The proper USR tuning will, however, allow you to operate with greater power without distortions and danger to the amplifier.

The real power in the load is equal to the difference between the FORWARD- and REFLECTED- bar-graph readings. For instance, at indicator reading for FORWARD 1775W, and for REFLECTED 275W, the real output power is 1500W. At very high VSWR (lack of antenna or shortened antenna), the FORWARD and REFLECTED readings will be almost equal, while the real output power (the difference between them) will be practically zero.

The amplifier can operate safely if the following rule is obeyed: REFLECTED POWER < 500W. Matching can be assured for loads with VSWR up to 3:1 (for 160m - 2:1). Nevertheless, for some loads matching is possible even at higher VSWR.



DANGER

Using a feeder of coaxial cable at VSWR > 3:1 on HF bands is not recommended. At such high values of VSWR, the high voltages, high currents, and heat associated with line losses, risk permanently damaging the coaxial cable.

Always prefer USER- to DEFAULT- tunings and update them periodically, in particular when you install a new antenna or when a significant change in the environment occurs (snow, ice, newly appeared or removed massive objects, power lines etc.) that would cause significant changes in the antenna impedance.

- b) Procedure for preparation of USER-tunings.

We recommend that you prepare USER-tunings for the center frequencies of the segments, but you can do them for other preferred frequencies.



NOTE

If you use more than one antenna per segment, it is necessary that you select the proper antenna number (see Section **4.1.d) A NEW ANTENNA**) BEFORE the next step. Otherwise you may overwrite some useful tuning for another antenna number.

The following instructions are valid if your amplifier is not connected to the transceiver by CAT (or the CAT connection is of RX only type, which is rare but possible if there are other devices connected via Y cable).

If there is a two-way CAT connection between the transceiver and ACOM 2000A, skip to Section **4.2.c) ACOM 2000A connected by CAT to a transceiver**.

To begin AUTO TUNE while in the MAIN menu, press the TUNE button and you will see the following display:

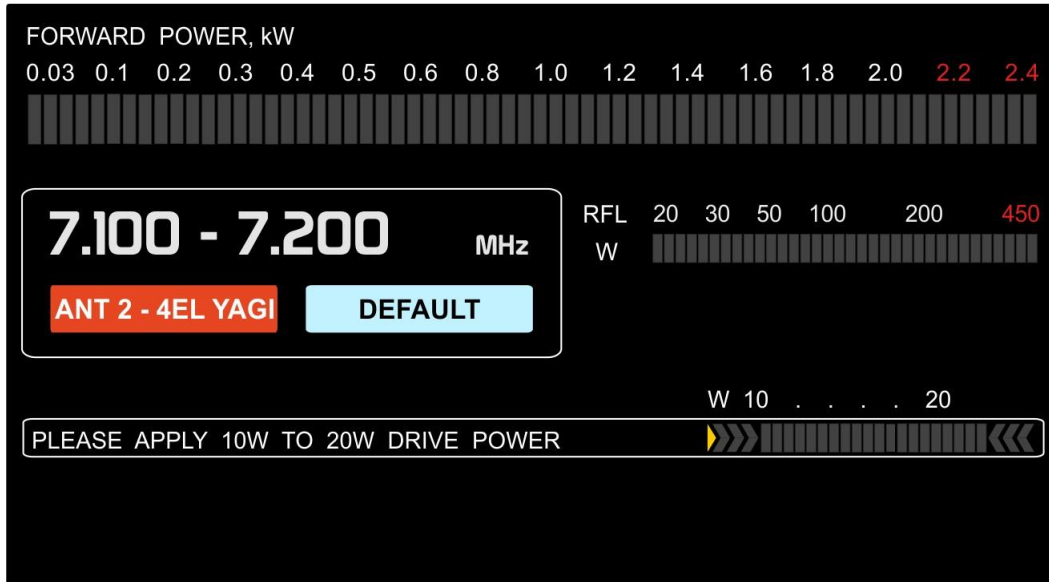

Figure 4-4 RCU display - AUTO TUNE

The amplifier will wait for you to apply between 10 and 20W continuous (CW) carrier signal on the desired frequency. If you don't begin transmitting within 40 seconds, the amplifier will return back to the MAIN menu.

The automatic matching process starts the moment power remains constant within the indicated boundaries. This is shown by the bottom bar graph, which indicates the applied input power and glows in yellow:



If the drive power is less than 10W or greater than 20W, the yellow arrows will remind you to correspondingly increase or decrease the drive:



The antenna impedance matching process is completed in less than 3 seconds and AUTO TUNE COMPLETED PLEASE REMOVE DRIVE message is displayed as shown in **Figure 4-5** Figure 4-5 RCU display - end of AUTO TUNE and the letter S is being sent in CW:

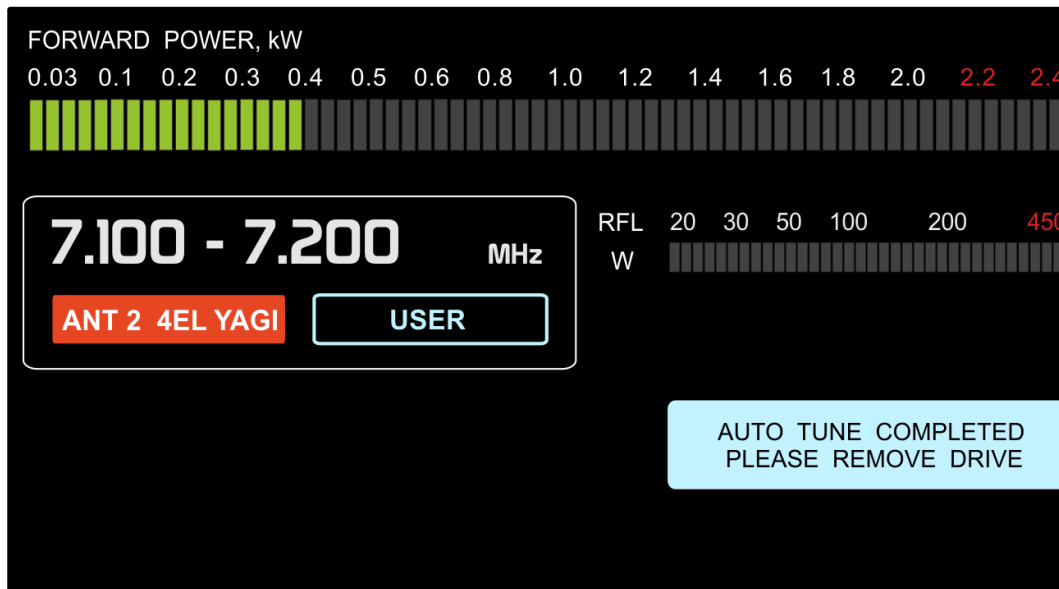

Figure 4-5 RCU display - end of AUTO TUNE



NOTE

If the KEY-OUT control is used (see Section 2.4.e), the above message will be skipped.

If for some reason matching cannot be accomplished successfully (for example excessive VSWR or unstable drive power during tune-up), the process ends up with the choice of DEF-tuning and you will hear K being sent in CW.

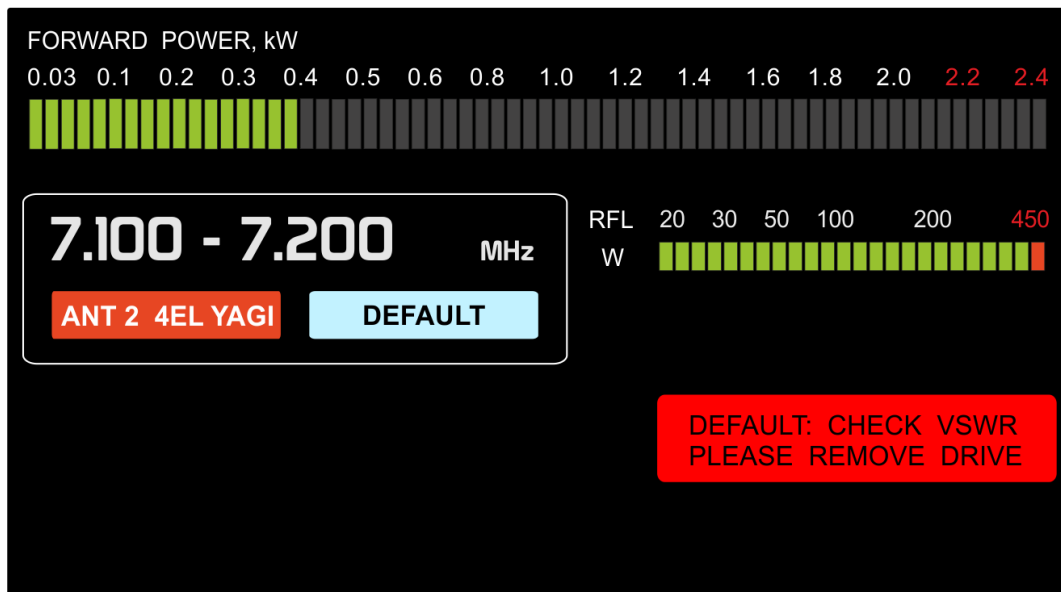

Figure 4-6 RCU display – AUTO TUNE fail

After removing drive power, the RCU returns automatically to the MAIN menu with USER or DEFAULT indicated.

- c) ACOM 2000A connected by CAT to a transceiver

If you are using your ACOM 2000A connected by CAT to a transceiver, the USER tuning preparation procedure is extremely simple.

- If the transceiver is FT-450, FT-950, FT-2000, FT-3000, FT-5000, FT-9000, IC-756PROIII, IC-7410, IC-7600, IC-7700, IC-7800, K3, TS-480, TS-590, TS-990, TS-2000, or another modern CAT protocol enabled radio, you need only to push the RCU TUNE button. ACOM 2000A does the rest by itself.

- If your transceiver is not one of those listed above and its output power can't be controlled by CAT, you must set the output power to between 10 and 20W and push the TUNE button, or reduce the power and adjust it as explained above in para 4-2b after pushing the TUNE button.

4.3. Erasing USER segments (return to DEFAULT- tunings)

If you wish to clear a USER setting for a frequency segment and/or antenna, there are two ways this can be accomplished:

- a) To clear all memorized USER-tuning settings – while in OFF MENU, select CLEAR the USER TUNINGS (see Section 6.5 CLEAR THE USER TUNINGS).

- b) For selected segments and/or antennas:
- Select the segment and antenna for which you want to erase the USR-tuning (see Section **4.1.c) ON AIR and 4.1.d) A NEW ANTENNA**);
 - Enter "MANUAL MODE", select "SETTINGS" and choose "CLEAR THE SEGMENT TUNING" (see Section **5.5.c) CLEAR THE SEGMENT TUNING**).

5. MANUAL MODES

Pushing the SET/EXIT key (*Figure 3-1 Remote Control Unit (RCU)*) while in main menu will get you to the MANUAL MODE:

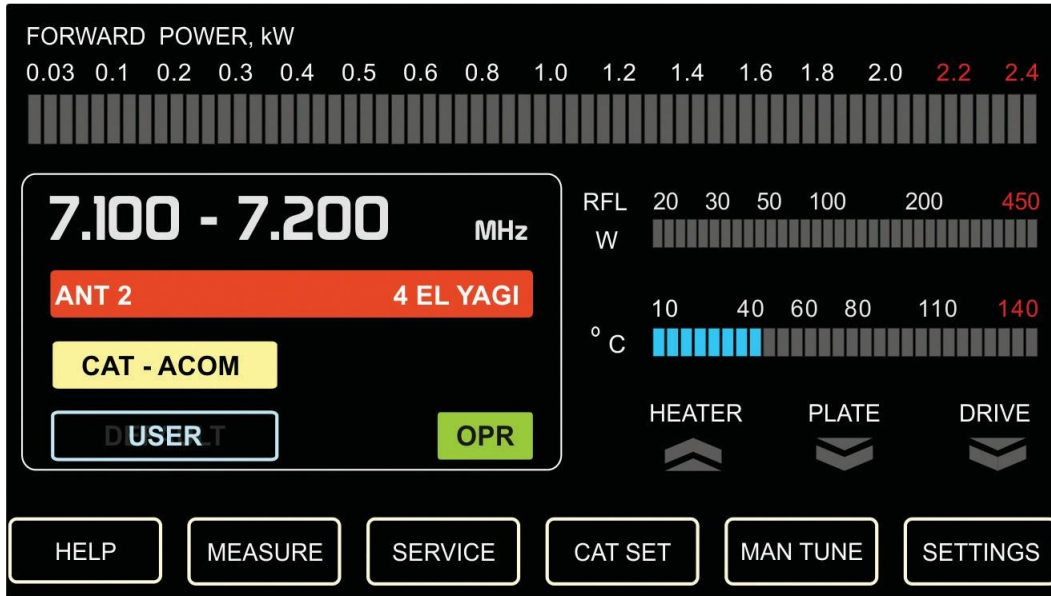

Figure 5-1 RCU display - MANUAL MODE

Now you have access to some functions, procedures, and settings, which are marked on the soft key prompting labels.

5.1. MANUAL TUNE



WARNING

During the manual tune process, be certain to keep transmissions to less than 3 minutes in duration and leave pauses of 1-2 minutes between transmissions for cooling of the tubes.

If for some reason you prefer to match the antenna impedance manually, you can do so through the MAN TUNE procedure. The procedure starts the same as for AUTO TUNE, but you will need to adjust the LOAD and TUNE settings yourself as described below:

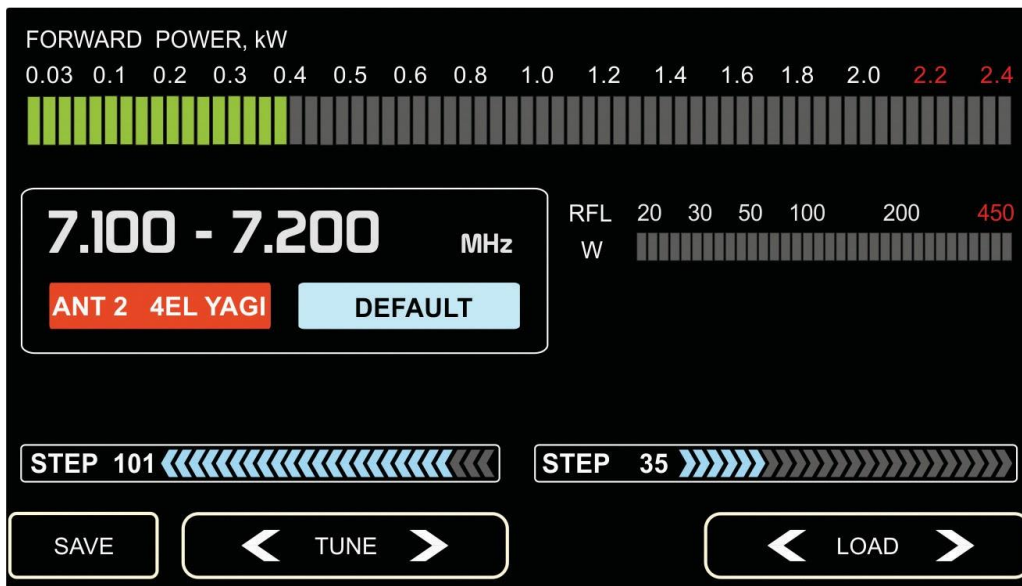

Figure 5-2 RCU display - MANUAL TUNE

In **Figure 5-2 RCU display - MANUAL TUNE**, graphical representations of the physical positions of the Tune (STEP 101) and Load (STEP 35) capacitors are depicted above their respective TUNE and LOAD dual-arrow adjustment buttons. The arrows indicate which way the automatic procedure would move the motor (they are correct only at drive power of 5 to 50W).

By pressing the left and right arrow buttons you can increase or decrease the step number which in turn moves the motors and capacitors. To end the manual tune procedure and save the tuning as USER, remove drive power and press the SAVE button.

If you decide to leave the procedure without overwriting the current tuning, push the SET/ EXIT button.

If you adhere to the tune-up criteria following the arrow prompts, you will achieve the same results as AUTO TUNE. Because of this, the MAN.TUNE procedure is only appropriate if you have tune-up criteria of your own. We recommend you use the AUTO TUNE procedure instead.

5.2. MEASURE function

The function MEASURE controls the technical state of the amplifier and the parameters associated with it. The TFT display is divided into two equal display areas, and in either you can monitor any of the 20 parameters provided for measuring, for example GRID BIAS VOLTAGE and DC SCREEN VOLTAGE:

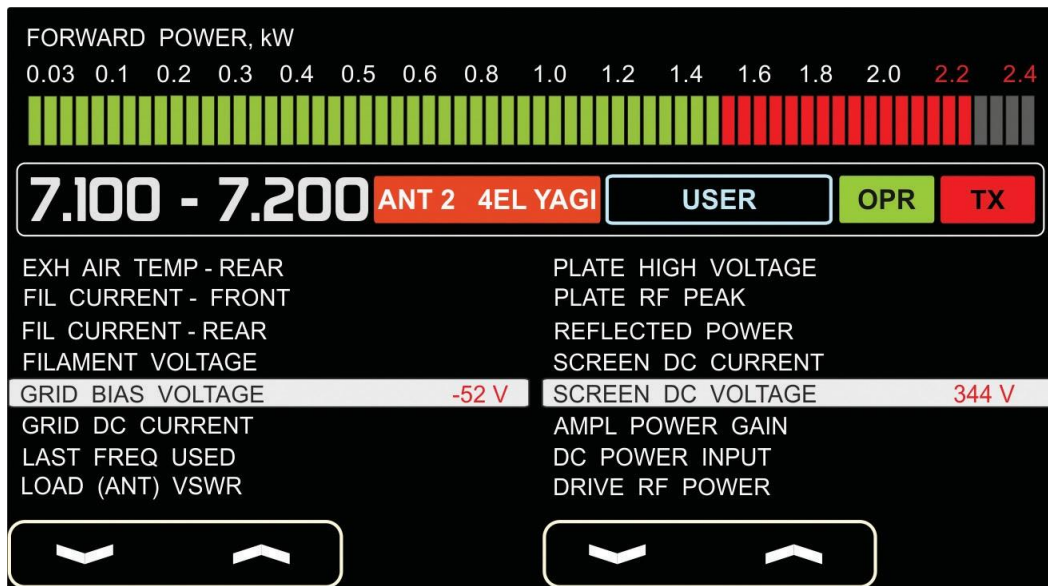

Figure 5-3 RCU display - MEASURE

With the up and down buttons, you can select the item to be measured (listed in an alphabetic order).

During measuring, the amplifier can be used and controlled in OPR or STB modes, to transmit and change the frequency segment and antenna if a new frequency is applied to it. Return to the MAIN - menu is done by the SET/EXIT button.

The following is a list of parameters that can be measured:

- AMPLIFIER POWER GAIN
- DC POWER INPUT
- DRIVE RF POWER
- EXHAUST AIRFLOW TEMPERATURE - FRONT TUBE
- EXHAUST AIRFLOW TEMPERATURE - REAR TUBE
- FILAMENT CURRENT - FRONT TUBE
- FILAMENT CURRENT - REAR TUBE
- FILAMENT VOLTAGE
- GRID BIAS VOLTAGE
- GRID DC CURRENT
- LAST FREQUENCY USED
- LOAD (ANTENNA) VOLTAGE STANDING WAVE RATIO
- LOAD (ANTENNA) FORWARD POWER
- MAINS VOLTAGE
- PLATE DC CURRENT
- PLATE HIGH VOLTAGE VALUE
- POWER REFLECTED FROM LOAD (ANTENNA)
- PLATE RF AMPLITUDE (PEAK VALUE)
- SCREEN DC CURRENT
- SCREEN DC VOLTAGE.

5.3. SERVICE procedure

The procedure SERVICE can be selected and used only in STB mode. It is used for adjustment of the zero-signal plate current and the optical sensors disks during repair. We recommend this procedure to be carried out only by a trained service technician.

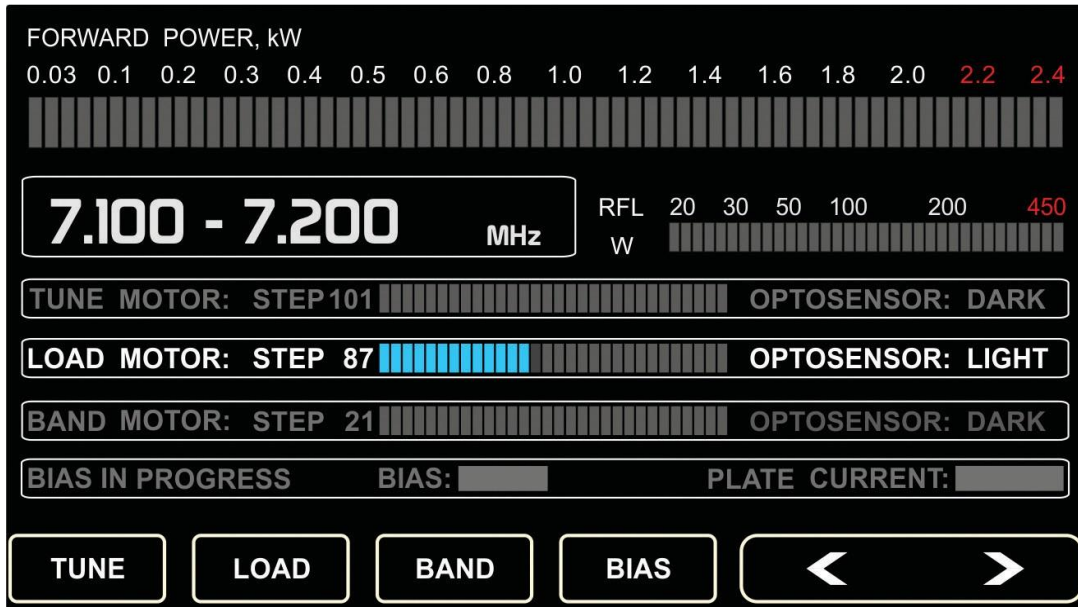

Figure 5-4 RCU display - SERVICE

When selecting TUNE, LOAD or BAND, the respective motor can be moved step by step CCW or CW with the left and right arrow buttons. The positions of the motors are shown in a numerical and in a graphical form. The status LIGHT or DARK of the respective optical sensors are also displayed.

When the BIAS function is activated, it starts an automatic switching queue over three different grid bias voltages. The voltages are shown along with the respective measured DC plate current. This is used when the tube idling current adjustment is required.

If the amplifier remains in the SERVICE sub-menu for more than 5 minutes without any further RCU input, it will return automatically to the MAIN menu and the stepper motors will tune the plate circuit to the current frequency segment. For more information see the Technical Supplement.

5.4. CAT SETTINGS

Here you set the type of the transceiver connected by CAT to the amplifier. Use the UP and DOWN buttons to move the pointer and exit with SET/EXIT button. Pay attention to the communication speed shown in the brackets next to each transceiver type. Set your transceiver serial port to the same Baud rate (speed).



Figure 5-5 RCU display – CAT SETTINGS

A transceiver that is not included in the list still could be CAT connected to the 2000A if its protocol is compatible with any of the listed transceivers.

Select KENWOOD NEW if your transceiver is TS-570, TS-870, TS-480, TS-590, TS-990, TS-2000 or newer. KENWOOD TS-850 covers also TS-950 as well as TS-440, TS-940 with optional units.

YAESU FT-1000D can be selected for some FT-1000 and FT-990 versions.

YAESU FT-897 covers also FT-847, FT-857 and FT-817.

YAESU NEW includes FT-450, FT-950, FT-2000, FT-3000, FT-5000 and FT-9000 or newer.

5.5. MORE SETTINGS

Some more items can be set through this menu.

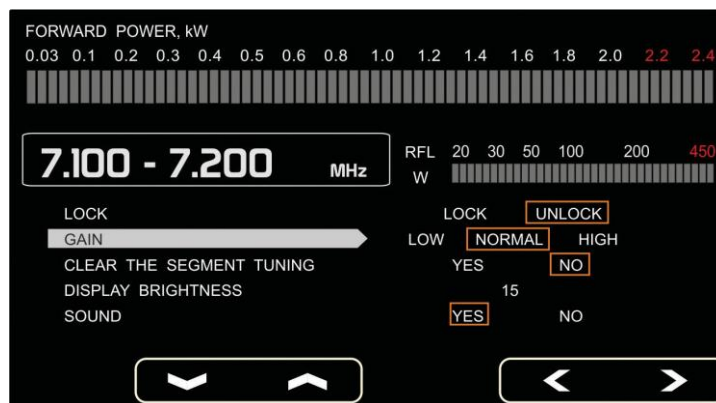

Figure 5-6 RCU display – MORE SETTINGS

a) LOCK

Once locked through this option, the amplifier can be switched on, but it will not turn into OPERATE state until entering the same menu and choosing UNLOCK. This feature is intended to protect the amplifier from children, or from other persons, not familiar with the equipment. The locked state is indicated by a displayed image of a key.

b) GAIN

**NOTE**

Inappropriate use of this function may reduce the gain or the maximum undistorted output power.

In fact, this selection controls the tubes plate load resistance achieved by AUTO TUNE procedure.

When HIGH is selected, a next AUTO TUNE will result in a higher than nominal load resistance, thus there will be more gain, but less maximum attainable output power. When available drive power is insufficient or when less output but better efficiency is needed, e.g., for RTTY and SSTV, this may be desirable and you may select HIGH also at a nominal mains voltage condition.

Selecting LOW would lead to the opposite result, i.e., lower than nominal load resistance, less gain, and more power attainable. Of course, this requires more drive power, more plate current, and more plate heat, which shortens tubes expected life. We do not recommend this selection at normal mains voltage and never at increased mains voltage. You may use it in conditions with lower than nominal mains voltage.

Departure from NORMAL selection should be mainly used to compensate for small line (mains) voltage variations in order to maintain tubes efficiency and linearity at deviated mains voltage. However, when there is more than plus or minus 5% deviation from the nominal line (mains) voltage, the voltage selector inside the amplifier should be changed (see Section 2.2).

A LOW-NORMAL-HIGH change requires refreshing the USER tunings in order to take place.

c) CLEAR THE SEGMENT TUNING

Use this entry if you want to erase a single USER tuning. Choosing YES will restore the DEFAULT tuning for the current segment and antenna at leaving the menu.

d) DISPLAY BRIGHTNESS

The display brightness can be adjusted through the left and right arrow buttons.

e) SOUND

You can turn ON and OFF the RCU internal beeper. When turned ON, the amplifier will alert you with a beep, or CW characters at the start and at end of some procedures, as warmup and autotune. Every fault that would trip the protection also will be indicated by letter F in CW.

f) ANTENNAS

To enter the antenna list, press the down button one more time when the marker is on the last line.

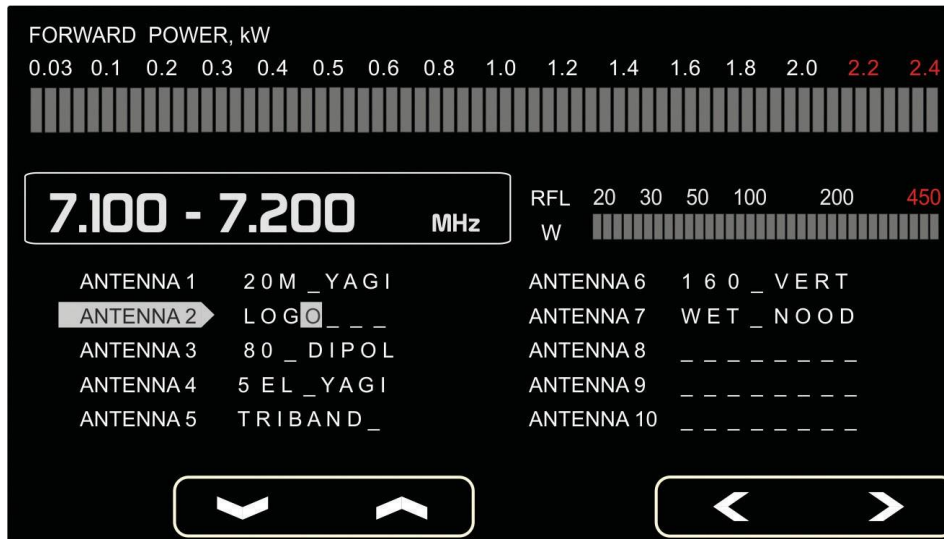

Figure 5-7 RCU display – MORE SETTINGS – ANTENNAS

Here you can give a name to each antenna, which will be displayed next to its number on the screen. First select the antenna number with up and down buttons. Use the left and right arrow buttons to choose the character position. Then select the character with up and down keys. The name can consist of up to 8 characters. When finished, return to the antenna number with the left arrow button. You can return to the first page of MORE SETTINGS menu with the up key, or you can exit to MANUAL MODE by pressing the SET/EXIT button.

5.6. HELP

When HELP is selected (*Figure 5-1 RCU display - MANUAL MODE*), you can choose one of the help topics by means of the up, down and select keys. The help topics have the same titles as the sections in this manual. Under the title AMPLIFIER INFO you may see the Revision Code of the firmware, the Running Time of tubes, the Serial Numbers of Amplifier and Tubes (front and rear).

During normal operation of the amplifier, information is stored in the nonvolatile memory about the 12 most recent protection trips or irregularities and the time when they have occurred (indicated as tube working hours). This information can be read if you select LAST 12 PROTECTION TRIPS.

6. OFF MENU

When the main power switch on the front panel is turned ON but the amplifier is still in OFF state, a number of settings can be changed by means of the OFF MENU – (see *Figure 3-3 RCU display - OFF MENU*). You can enter it by pushing the SET/EXIT button.

Use the Up and Down buttons to select an item, then push left or right arrow buttons to choose the value.

6.1. CALL SIGN

You can select any 9-character text to appear in the OFF-MENU (for example your own CALL SIGN). The Up and Down buttons select the character in the position indicated by the cursor (the characters are in an alphabetic order by the ASCII-code). The left and right arrow buttons move the cursor left or right to select different character positions. When finished, return to the CALL SIGN label with the left arrow button.

Erasing the nonvolatile memory (see Section *6.6 CLEAR THE MEMORY*) will blank the CALL sign message until the text is reprogrammed following the procedure described above.

6.2. AUTO ANTENNA CHANGE

When YES is selected, changing frequency segments (manually or following the transceiver frequency or by CAT – see Section *4.1.c) ON AIR*), will cause the antenna last used in the respective segment and the tuning settings for it to be selected. This is convenient when you have 1 or 2 antennas for each band. With more antennas you would have to keep track of which antenna you used last.

If NO is selected, this function is disabled and the currently used antenna is changed only after an intentional command is given for an antenna change (manually or via the local network - see Section *4.1.d) A NEW ANTENNA*). When changing frequency segments, the tuning settings for the antenna currently used will be selected in the new segment. This mode is preferred when you have multiple antennas per band.

Selection of YES or NO does not change any contents for tuning settings in the nonvolatile memory.

6.3. AUTO OPERATE

Set to OFF by default.

When ON is selected, the amplifier will remain ready to operate, even automatically returning from standby after a soft-fault protection trip. That is, after a protection trip, e.g. from an overdrive event, the amplifier will normally shift to the STB mode for about four seconds, but it will automatically return to the OPR mode after that. Even with ON selected however, you still may depress the OPR hardware button manually to go to and remain in the STB (Stand By) mode at any time, such as when you leave the station for a while.

If OFF is selected for AUTO OPERATE, the amplifier will go and remain in the STB mode after a soft fault until switched over to the OPR mode manually by the operator or an intended command is received via the local network.

6.4. SELF ADDRESS

Here you can set the amplifier self-address for operation in a network with other systems. When the amplifier is not used in a network, this address is meaningless.

6.5. CLEAR THE USER TUNINGS



NOTE

If you use this function, it is advisable that you update the USR tunings (see Section [4.2 AUTO TUNE procedure](#)).

When selected YES, this function clears all USR-tunings from the nonvolatile memory but does not change anything else in the INFO-BOX.

The use of CLEAR THE USER TUNINGS is convenient when the amplifier is moved to another operating place to prevent from mixing with the remaining USR-tunings which are valid for the antennas at the old location. Of course, if the total number of antennas is less than 10 per segment, you can do USR-tunings with new antenna numbers and thus preserve the USR-tunings for the antennas at the old location as well.

6.6. CLEAR THE MEMORY



NOTE

Erasing Nonvolatile Memory erases all user data for the amplifier stored in its nonvolatile memory and the INFO-BOX.

This includes the following:

- The elapsed hours on is set to zero;
- The text set for CALL is deleted;
- The information stored for recent 12 protection trips is cleared;
- Selection for LOW-NORMAL-HIGH of GAIN is set to NORMAL;
- The amplifier self-address in local network is set to 01;
- The last segment and antenna in use is set to 1800-1825 ANT1;
- All USR-tuning settings for all segments and antennas are set to DEFAULT;

- The auto antenna change mode is set to ON;
- The AUTO OPERATE selection is set to OFF.

If you are fully convinced that you want all of these actions to take place, choose YES and then leave the menu pressing the SET/EXIT button.

The procedure is now completed and the amplifier remains in OFF state with no user data in it. The serial numbers of the RCU, amplifier and its tubes as well as the firmware revision code and Default tuning settings, however, are preserved.



NOTE

After this procedure set new data in OFF-menu and update the USR-tunings for the frequency segments and antennas to be used (see Section **4.1 MAIN MENU**).

7. CAT OPERATION AND CONNECTIONS

Most of the modern transceivers that have the operating frequency data available on an auxiliary serial port could be connected to ACOM 2000A by means of a CAT connection. This will enable the amplifier to track the frequency of the transceiver and to tune up automatically when entering a new segment without transmitting.

Because of the variety of CAT protocols, the amplifier response could vary when used with different transceivers.

Some older transceivers use very slow protocol and send the frequency data with delay up to few seconds. The amplifiers response will also be delayed. In some cases when the transceiver is turned ON after the amplifier you may need to actuate the RCU CAT/FREQ button in order for the radio to announce its frequency.

In other cases, the transceiver sends the frequency data only when the frequency changes. You may have to move its main dial, or change its frequency by another way to let the amplifier know the transceiver frequency after the initial power ON.

Not all transceivers correctly report VFO A and VFO B when in split mode. If yours transmit and receive frequencies are in different band segments and the amplifier retunes on every RX/TX transition, turn off the CAT until the end of the split operation.

The CAT connector is located on the RCU rear panel. Besides the RS232 and TTL compatible serial interface, the CAT connector also carries the KEY IN and KEY OUT lines, which can be used instead of using separate cables for those functions from the transceiver to the sockets of the same names. See **Figure 7-1 CAT Connector pin-out front view**:

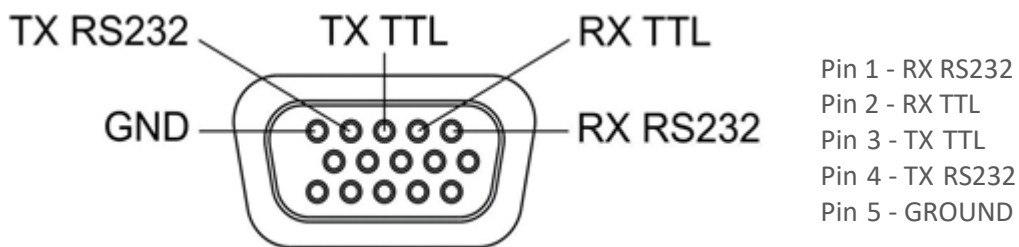

Figure 7-1 CAT Connector pin-out front view

Many transceivers have different connectors and different signal levels. To be sure that your radio will interface properly with ACOM 2000A, the connection cable should be prepared according to and the corresponding information from your transceivers User manual.

Here are some examples.

Please note that the front view of the cable connectors is shown in these pictures.

- Y serial cable

When the CAT port of the transceiver is used for another device such as a computer or an antenna controller, a Y cable should be used. An example is shown on **Figure 7-2 CAT Connection by RS-232 Y cable**. Use only shielded cables for all connections. Note that the amplifier will receive correct data only when the CAT connection between the transceiver and the other device (for example, a computer with running logging software) is active.

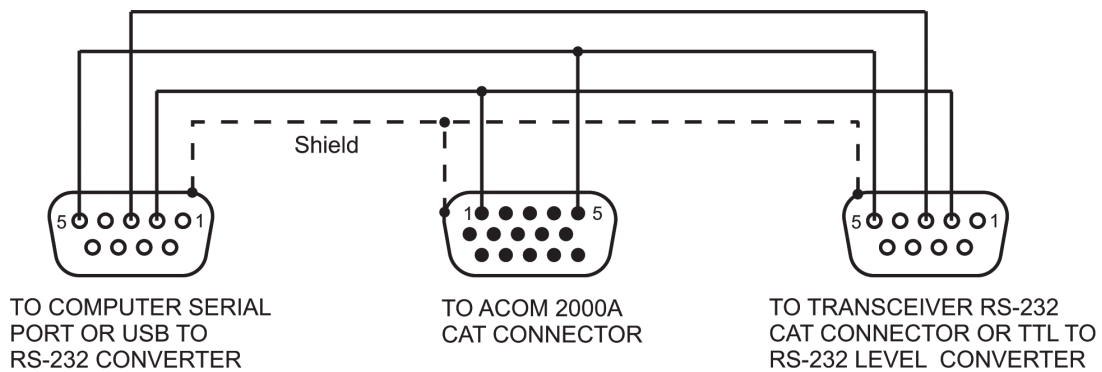

Figure 7-2 CAT Connection by RS-232 Y cable

- ICOM CI-V Interface

A 3.5mm audio stereo plug, a two-conductor shielded cable and two 510 Ohm resistors are required. The wiring is shown on **Figure 7-3 CAT Connection to ICOM CI-V interface**.

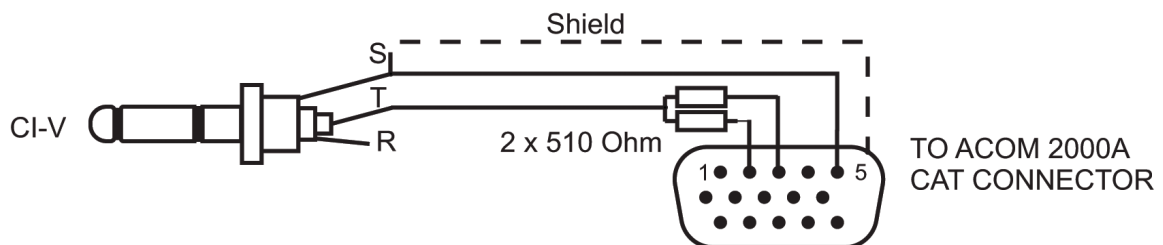

Figure 7-3 CAT Connection to ICOM CI-V interface

- **KENWOOD TS480, TS570, TS590, TS870, TS2000, TS..40 with optional unit or TS..50 with optional unit**

You need a female DB9 connector and a three-conductor shielded cable. The wiring should follow **Figure 7-4 CAT Connection to KENWOOD RS-232 interface**, including the connection between pins 7 and 8 of the DB9 connector. If the same port of the transceiver is used for computer control, you can use Y cable shown on **Figure 7-2 CAT Connection by RS-232 Y cable** with an addition of a connection between pins 7 and 8 at the transceiver side.

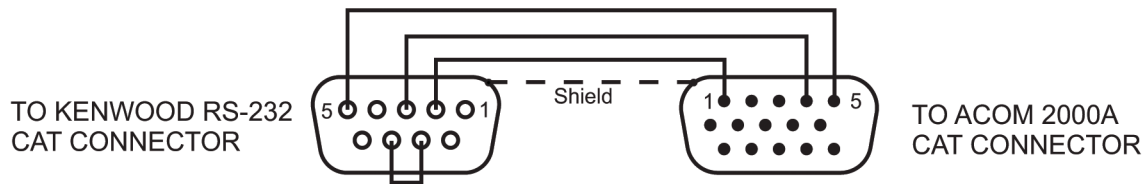

Figure 7-4 CAT Connection to KENWOOD RS-232 interface

- **KENWOOD TS450, TS850 and TS950**

If an optional RS-232 interface is present you may use the cable of **Figure 7-4 CAT Connection to KENWOOD RS-232 interface**. Otherwise, the built-in TTL serial interface can be used, as shown on **Figure 7-5 CAT Connection to KENWOOD TTL interface**. Use shielded cable and universal low power NPN transistors.

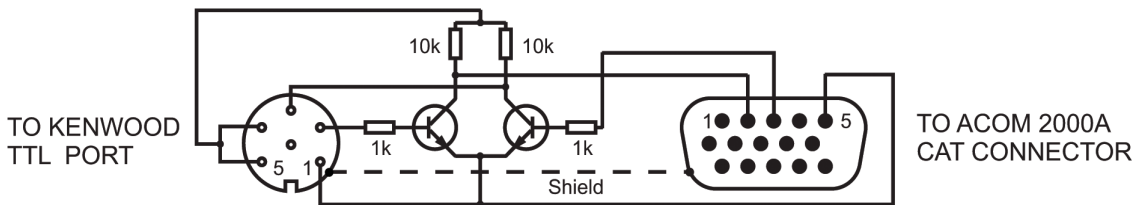

Figure 7-5 CAT Connection to KENWOOD TTL interface

- **Elecraft K3**

You can use a shielded cable, wired according to **Figure 7-6 CAT Connection to Elecraft K3**. The RS-232 connector at the transceiver side is a male DB9. If the same port of the transceiver is used for computer control, you can use Y cable shown on **Figure 7-2 CAT Connection by RS-232 Y cable**.

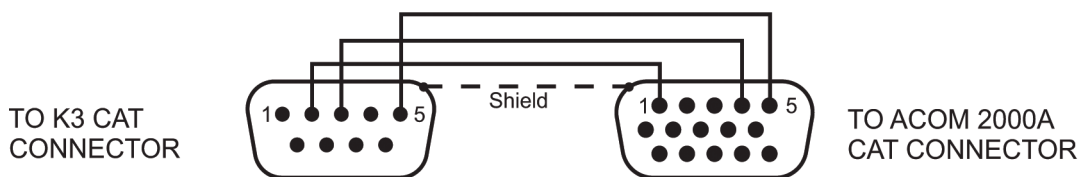

Figure 7-6 CAT Connection to Elecraft K3

- YAESU FT450, FT847, FT920, FT950, FT1000MP, FT2000, FT5000 and FT9000

You need female DB9 connector and a three-conductor shielded cable. The wiring should be as shown in **Figure 7-7 CAT Connection to Yaesu transceiver with RS-232 interface**. If the same port of the transceiver is used for computer control, you can use Y cable shown on **Figure 7-2 CAT Connection by RS-232 Y cable**.

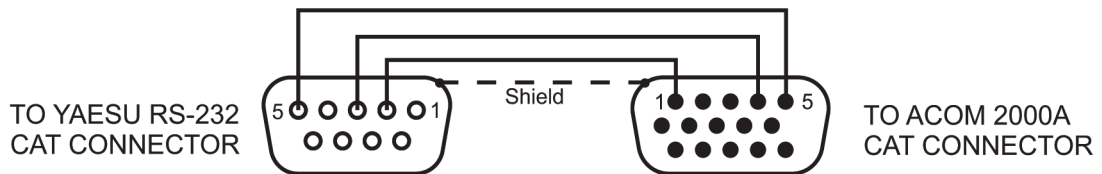

Figure 7-7 CAT Connection to Yaesu transceiver with RS-232 interface

- YAESU FT-990, FT-1000 and FT-1000D

You will need a 6-pin DIN connector, 3 wire shielded cable and a 10k pull-down resistor as shown on **Figure 7-8 CAT Connection to YAESU FT-1000D**.

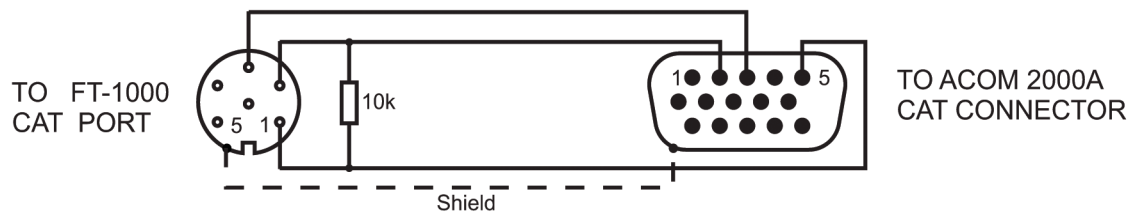

Figure 7-8 CAT Connection to YAESU FT-1000D

- YAESU FT-817, FT-857 and FT-897

The cable is shown in **Figure 7-9 CAT Connection to YAESU FT-897**. Besides the serial interface wires, also the amplifier control lines are included in the same connector. This makes possible using of a single cable between the transceiver and ACOM 2000A as shown on **Figure 7-9 CAT Connection to YAESU FT-897**. The connector at the transceiver side is a Mini 8 pin DIN. You will also need a 5-wire shielded cable and a 10k pull-up resistor. In case of using this cable, you should not connect separate cables to the KEY-IN and KEY-OUT sockets described in Section 2.4.d) and Section 2.4.e).

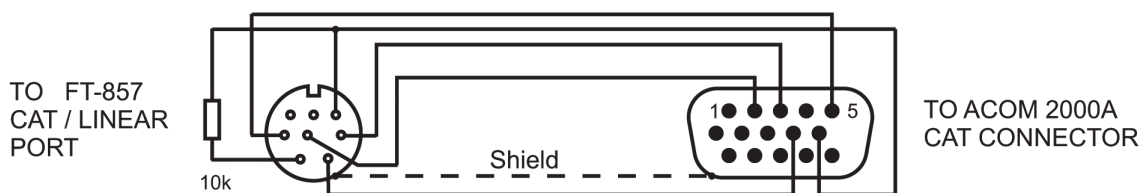

Figure 7-9 CAT Connection to YAESU FT-897

8. MAINTENANCE



WARNING! HIGH VOLTAGE!

The amplifier works with high voltages up to 3000V, which are LETHAL!

For your safety, pull the amplifier power plug out of the mains wall outlet and WAIT AT LEAST 30 minutes EACH TIME BEFORE you remove the cover of the amplifier. Do not touch any part inside while the amplifier is open because some residual voltages may still be present.

8.1. Cleaning



WARNING

Do not use solvents for cleaning - they may be dangerous both for you and for the amplifier paint.

Do not open the amplifier. Cleaning of the amplifier and RCU outer surfaces can be done with a piece of soft cotton cloth lightly moistened with clean water.

8.2. Backup Battery Replacement

If the RCU displays a message: LOW BATTERY-DATA IS IN DANGER or LOSS OF STORED DATA-CHECK BATTERY PLEASE, it is necessary that the nonvolatile memory battery for USR-TUNINGS be replaced. This is a 3V/38mAh coin-type lithium battery with a diameter of 12mm (~1/2inch) with leads for soldering. The following types are suitable:

- BR1225T2-1 made by RAYOVAC USA
- BR1225-1HC made by PANASONIC.

This is a complex and possibly dangerous operation. For this reason, ACOM recommends that this work be carried out by a trained service technician. See the Technical Supplement for details. The expected life of a new battery is at least 5 years.

8.3. Fuse Replacement

If circumstances require replacement of the mains fuses, use only standard ones.

The two Primary Mains Fuses of the amplifier are located on the rear panel (Fig. 2-2). They are 20A/250V Quick blow, 1-1/4 x 1/4 inch Cartridge Fuses, Size 0 Ceramic.

Besides these primary fuses, there are 6 (six) small glass fuses (5x20mm) on the MAINS CONTROL BOARD which are not to be replaced by the user. Should one of these fuses be blown, it may be indicative of other more serious failures. This is a complex and possibly dangerous operation. For this reason, we recommend this work be carried out by a trained service technician. See the Technical Supplement for details.

8.4. Tube Replacement

New tubes must be supplied as a Matched Pair with close electrical characteristics. Otherwise there may be an imbalance and one of the tubes will bear an excessive share of the operating current, which can lead to overheating and reduced tube life.

Two 4CX800A (GU74B / ГY74Б) high performance ceramic-metal tetrodes manufactured by Svetlana (Светлана) are employed in the amplifier. Tube replacement is a complex and possibly dangerous operation. For this reason, we recommend that this work be carried out by a trained service technician. See the Technical Supplement for details.

8.5. The ACOM 2000A Simplified Schematic Diagram

Please, see *Figure 8-1 ACOM 2000A Simplified Schematic Diagram*.

The two 4CX800A (GU74B / ГY74Б) Svetlana (Светлана) high performance ceramic-metal tetrodes (V1 and V2) with plate dissipation of 800W each are grid-driven. The input signal from the RF INPUT jack is passed through a broadband input matching circuit which is comprised of components in the PHASE DETECTOR PCB and also L1, L2, C2, C3 and R1. This circuit tunes out the input capacitance of the tubes. The resistor R1 is a termination load of this circuit and can dissipate up to 100W of drive power.

Cathode resistors R2 and R5 create DC and RF negative feedback and equalize the gain of the tubes. The varistor RV1 in the screen grid circuit protects the tube screen grid, and voltage regulator in the events of a flashover.

The combinations of L3-R3 and L4-R6 in the plate circuits are the VHF/UHF parasitic suppressors. DC plate voltage is fed through chokes RFC2-RFC3 and the capacitor C10 blocks it from the output. The output circuit is comprised of L5-L6 and C12-C16, which form a classic Pi-L network and suppresses harmonic frequency emissions. It is switched and tuned over the bands by S1A-S1D and the stepping motors M3-M5 via the MOTOR DRIVER PCB. The output signal is fed through the vacuum antenna relay K1, wattmeter current transformer TA1 and high-pass filter RFC5-C20 and finally to the antenna output. The chokes RFC4 and RFC5 keep track of the antenna relay contact condition and together with C20 prevent the plate supply from reaching the antenna and RFC5 shunts it to ground if the DC blocking capacitor C10 fails. The resistor R9 and FV1 protect the amplifier from static discharge via the RF OUT connector.

The PHASE DETECTOR together with the PLATE CAPACITIVE DIVIDER, RF WATTMETER and three OPTOSENSOR circuits are the main sources of information for the control circuit of the amplifier during the autotune process. The control circuit consists of the CENTRAL PROCESSOR UNIT, based on the ATMEGA2560 microprocessor as the main system and the ATMEGA48 single chip microprocessor which is used as the antenna relay QSK controller. They are interfaced through the INTERFACE PCB to all other circuits.

All voltages delivered from the LOW VOLTAGE and HIGH VOLTAGE SUPPLY PCBs, tube currents, temperatures and airflow cooling capability are permanently monitored. Numerous software-derived protection limits are based on this information.

The SIGNAL FILTER PCB and RFC1 eliminate RF feedback from incoming cables, including the mains power cord. The Remote Control Unit (RCU) is based on the ATmega64 microcontroller and uses a 7" color TFT display.



N O T E

Detailed electrical schematic diagrams are available in the Technical Supplement. Contact your dealer for details.

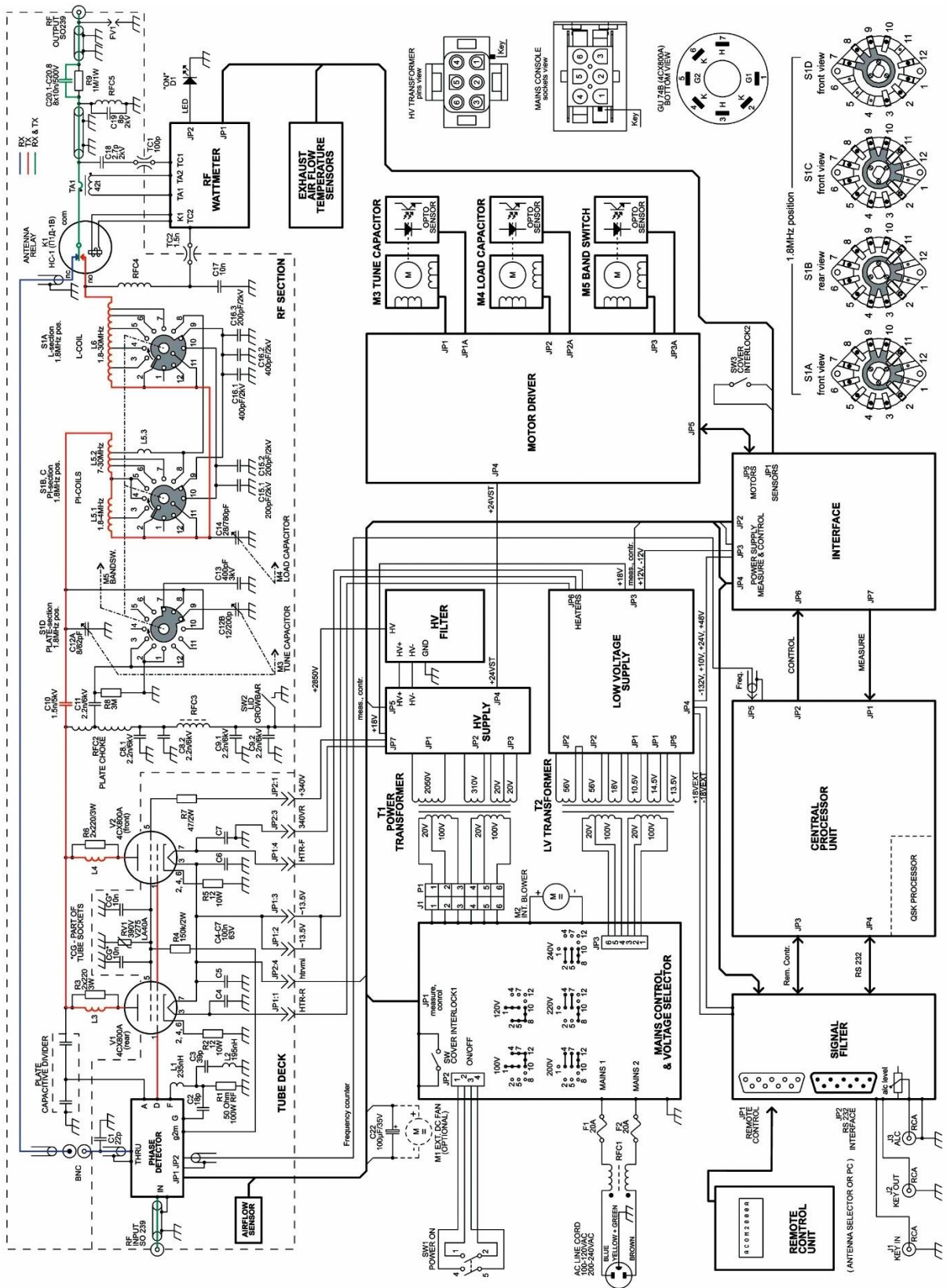

Figure 8-1 ACOM 2000A Simplified Schematic Diagram

8.6. Troubleshooting

Should the RCU display indicate a problem, look up the message in the list below and before you contact the service of your dealer (see Section **1.2 Owner Assistance** and Section **5.3 SERVICE procedure**), try the recommendations. The messages are listed in an alphabetic order. The abbreviations used for some recommendations are decoded after the list.

In case of necessity of transportation see Section **9.3 Storage and Shipment**.

MESSAGE	RECOMMENDATION
ADC - OVERFLOW	OFF5*
ANTENNA CONTROL UNIT MALFUNCTION	Check the control cable from the amplifier INTERFACE connector to ACU (Antenna Control Unit, if there is one).
ANTENNA RELAY CLOSED IT SHOULD BE OPEN	CCC*
ANTENNA RELAY OPEN IT SHOULD BE CLOSED	CCC*
ARC FAULT	Try again; check antenna cable, selector, antenna and grounding for loose contacts or worsened insulation.
AUTOMATIC PROTECTION DRIVE POWER REMOVED	Power not removed more than 10 seconds after the message "REMOVE AND REDUCE DRIVE POWER" appeared.
BAND SWITCH SYSTEM MALFUNCTION	OFF5*
BIAS CONTROL MALFUNCTION	OFF5*; CCC*
BIAS TOO LOW AT POWER ON	OFF5*; CCC*
BIAS VOLTAGE TOO LOW	OFF5*; CCC*
CAT CONNECTION FAULT	Check the CAT cable, the CAT settings and the transceiver CAT settings
COVER INTERLOCK OPEN	Check cover; OFF5*
DETECTED RF POWER AT WRONG TIME	Check if there is power in the antenna induced from another nearby transmitter; CCC; OFF5*
DRIVE FREQUENCY OUT OF RANGE	Check the transceiver frequency; OFF5*
DRIVE POWER TOO HIGH	RD&T*
EXCESSIVE G2 CURRENT	RD&T*
EXCESSIVE PLATE CURRENT	RD&T*
FREQUENCY VIOLATION	Submit to your dealer your license for operation in the respective frequency band.
FRONT TUBE EXHAUST TEMP TOO HIGH	Check if air intake (rear panel) and exhaust (above tubes) openings are clear of obstructions; RD&T*
G1: EXCESSIVE GRID CURRENT	RD&T*

MESSAGE	RECOMMENDATION
G2: CURRENT TOO HIGH	RD&T*
G2 CONTROL CIRCUIT MALFUNCTION	OFF5*
G2 VOLTAGE TOO HIGH	OFF5*; RD&T*
G2 VOLTAGE TOO LOW	OFF5*; RD&T*
HEATER CURRENT TOO HIGH	CMV*
HEATER CURRENT TOO LOW	CMV*
HEATER VOLTAGE TOO HIGH	CMV*
HEATER VOLTAGE TOO LOW	CMV*
HEATERS ON BEFORE TIMEOUT STARTED	OFF5*
HIGH VOLTAGE TOO HIGH	CMV*
HIGH VOLTAGE TOO LOW	CMV*
HV TOO LOW AT POWER ON	Check if the power transformer is properly connected (see Section 2.3); CMV*
IG2=.....mA SHOULD BE ZERO	OFF5*
IG1=.....mA SHOULD BE ZERO	OFF5*
I _p =mA SHOULD BE ZERO	OFF5*
I _p PRESENT: SHOULD BE ZERO	OFF5*
INPUT RELAY CLOSED IT SHOULD BE OPEN	CCC; OFF5*
LOAD CAPACITOR SYSTEM MALFUNCTION	OFF5*
LOSS OF STORED DATA CHECK BATTERY PLEASE	See Section 8.2
LOW BATTERY DATA IS IN DANGER	See Section 8.2
LOW AIRFLOW	Check if air intake (rear panel) and exhaust (above tubes) openings are clear of obstructions; RD&T*
LOW GAIN	RD&T*; check the coaxial cable from transceiver output to amplifier input.
MICROPROCESSOR CONFLICT	OFF5*
MOTOR VOLTAGE TOO HIGH	CMV*
MOTOR VOLTAGE TOO LOW	check if the power transformer is properly connected (see Section 2.3); CMV*
QSK BREAK in FAULT PROCESSOR CONFLICT	OFF5*; CCC*
REAR TUBE EXHAUST TEMP TOO HIGH	Check if air intake (rear panel) and exhaust (above tubes) openings are clear of obstructions; RD&T*;
REFLECTED POWER TOO HIGH	Check antenna cable, selector, antenna and grounding for loose contacts or worsened insulation; trim the antenna for minimum VSWR or use an antenna tuner; try another antenna; check if REFLECTED POWER is induced from another nearby transmitter.
REMOVE AND REDUCE DRIVE POWER	RD&T*
RF PLATE =.....V SHOULD BE ZERO	OFF5*; CCC*
RF GRID =.....W SHOULD BE ZERO	OFF5*; CCC*

MESSAGE	RECOMMENDATION
SCREEN VOLTAGE ON BEFORE TIMEOUT OVER	OFF5*
TUNE CAPACITOR SYSTEM MALFUNCTION	OFF5*
+5V TOO HIGH (TOO LOW)	CMV*
+/- 12V TOO HIGH (TOO LOW)	CMV*
+24V /+48V TOO HIGH (TOO LOW)	CMV*

Table 8-1 Troubleshooting, Error messages

*** Abbreviations:**

- OFF5 Turn the amplifier off for 5 minutes and try again
- RD&T Reduce drive power from transceiver; do AUTO TUNE - see Section **4.2 AUTO TUNE procedure**
- CMV Check the mains voltage and verify that it matches the voltage selector - see Section **2.2 Line Voltage Selection** and **Table 2-1 ACOM 2000A Individual Data**
- CCC Check the control cable from the transceiver to KEY-IN input - see Section **2.4 Connections**.

9. SPECIFICATIONS

9.1. Parameters

a) Frequency Coverage: All amateur bands 1.8-29.7MHz.

b) Power Output: 1500W PEP or continuous carrier, no mode limit.

In continuous carrier modes (RTTY etc.) for transmissions longer than 15 minutes (up to several hours depending on ambient temperature), the optional auxiliary fan must be mounted.

c) Intermodulation Distortion: Better than 35dB below rated PEP output.

d) Hum and noise: Better than 35dB below rated output.

e) Harmonics Output Suppression: Better than 50dB below rated output.

f) Input and Output Impedances:

- Nominal value: 50 Ohm unbalanced, UHF (SO239) type connectors;
- Input circuit: broadband, VSWR less than 1.3:1, 1.8-30MHz continuously (no tunings, no switching);
- Bypass path VSWR less than 1.1:1, 1.8-30MHz continuously;
- Output circuit matching capability: better than VSWR 3:1 (2:1 for 160m) or greater at reduced output levels; automated.

g) Automatic Tuning:

- Load Impedance Matching - less than 3 seconds;
- Band Change - less than one second;
- Segment Change - less than 0.2 seconds.

h) RF Gain: 14.5dB, frequency response less than 0.5dB (50 to 60W drive power for rated output).

i) ALC: grid-current derived, -11V max, rear panel adjustable.

j) Primary Power: 90-132V (100 & 120V nominal taps, 10% tol.) and 180-264V (200, 220 & 240V nominal taps, 10% tol.), 50-60Hz, single phase, 3500VA consumption at rated output. In USA, 240V is strongly recommended.

k) Complies CE safety and electromagnetic compatibility requirements, as well as FCC-regulations.

l) Size & Weight (operating): W440mm x D500mm x H180mm, 36kg.

m) Operating environments:

- Temperature range: 0 ... +50 deg. Celsius;

- Humidity: up to 95% @ +35 deg. Celsius;
- Altitude: up to 3000m above sea level without output deterioration.

9.2. Functions

- a) Load Impedance Matching Process: automated.
- b) Provides Antenna Control Interface for Automatic Antenna Selector and Tuner.
- c) User tuning settings memory - nonvolatile for up to 10 antennas per frequency segment (settings for 50 Ohm default provided).
- d) Tubes: two 4CX800A (GU74B / ГY74Б) Svetlana (Светлана) high performance ceramic-metal tetrodes with plate dissipation of 800W each, grid driven, forced air cooling.
- e) T/R System: QSK operation with built-in vacuum RF antenna relay.
- f) Protections:
 - Cover interlock for operator's safety;
 - Inrush power-on current control;
 - All supply voltages;
 - Control grid, screen grid, plate and heater currents;
 - Cooling airflow;
 - Exhaust air temperature - each tube separately;
 - Motors motion;
 - T/R sequencing;
 - Antenna relay contacts, including RF power induced in antenna from another nearby transmitter;
 - Load matching quality;
 - Reflected power;
 - RF arcs, including in antenna system;
 - Overdrive;
 - Unauthorized access to amplifier.
- g) INFO BOX for 12 recent protection trips, default selections, individual amplifier's data and elapsed power-on hours.
- h) Up to 20 meters separation between the RCU and the main unit, on-board assistance and troubleshooting suggestions etc. No controls on main unit (except for the ON/OFF main switch and LED indicator).
- i) All functions accessible from a computer via serial port, local network functions for more than one (up to 15) sets of amplifier / antenna units, working in a system.

- j) Measurement and/or constantly monitoring of 20 most important parameters of the amplifier via RCU and/or computer.
- k) RCU Beep.

9.3. Storage and Shipment



WARNING

Should you need to transport the amplifier, use the original packing as described below.

First pull the mains plug out of the mains outlet, afterwards disconnect all cables from the rear panel of the amplifier and RCU (remove the ground connection last) and wait 30 minutes. Then remove the mains power transformer, observing the requirements of Section **2.3 Transformer Installation**, but in reverse order. Pack the RCU in the box provided for it, and put it in the amplifier in the place of the mains transformer. Screw in the transport board to the transformer using the four shipping screws, pack the four shorter (mounting) bolts in the polyethylene envelope. Finally mount the cover and pack the amplifier and transformer in their original cartons.



NOTE

If transporting for repair, you may not need to ship your transformer – check with your dealer first.

- a) Storage environments: the amplifier can be kept packed in dry and ventilated unheated premises without chemically active substances (acids, alkalies etc.) in the following climatic environment:
 - Temperature range: -40 to +70 deg. Celsius;
 - Humidity: up to 75% @ +35 deg. Celsius.
- b) Shipping Size and Weight:
 - W390mm x D340mm x H340mm, 18.3kg - Transformer carton;
 - W630mm x D590mm x H300mm, 20.7kg - Amplifier carton.
- c) Shipping environments: all types of transportation, including aircraft baggage section up to 12000 meters above sea level.

10. BRIEF MENU GUIDE

- POWER SWITCH -> OFF STATE:
 - HELP - to read serial numbers, power-on hours, suggestions

- SET/EXIT BUTON -> OFF MENU
 - CALL SIGN – to change display message while in OFF-state
 - AUTO ANTENNA CHANGE – to select the logic of the antenna change
 - AUTO OPERATE – to select the behavior of the amplifier after a "soft" fault
 - SELF ADDRESS – to select the address of the amplifier if used in a network
 - CLEAR THE USER TUNINGS - to delete all USR-tunings
 - CLEAR THE MEMORY – to delete all stored data

- ON/OFF BUTTON -> MAIN MENU -> OPR/STB BUTTON - to activate and use the amplifier
 - AUTO TUNE - to match antennas (USR-tunings preparation)

- SET/EXIT BUTTON -> MANUAL MODE
 - MANUAL TUNE - to match loads manually
 - MEASURE - to measure various amplifier operating parameters
 - SERVICE - to check motors motion and tubes zero-signal current
 - CAT SETTINGS - to tell the amplifier what transceiver is connected to it via CAT

- MORE SETTINGS
 - LOCK - to protect the amplifier from unauthorized users
 - GAIN - to define mains voltage excursions
 - CLEAR THE SEGMENT TUNING - to erase a single segment USR tuning
 - DISPLAY BRIGHTNESS
 - SOUND
 - ANTENNAS - to set the antennas names

- ON/OFF BUTTON -> back to OFF STATE.



A series of 25 horizontal dotted lines spanning the width of the page, intended for user input or notes.

This manual is for electronic distribution mainly.
If you have it on paper and you no longer need it, please, recycle it!

The latest versions of our User's Manuals are available at
www.acom-bg.com

Dealer/Partner's address:

ACOM

HOW TO FIND US



📍 ACOM Ltd.
Bulgaria | Bozhurishte 2227
Sofia-Bozhurishte Economic Zone | 6 Valeri Petrov Str.
GPS coordinates: 42.748616° | 23.209801°

📧 support@acom-bg.com



www.acom-bg.com

ACOM and the ACOM logo are registered trademarks of ACOM Ltd. in many countries, including the EU and United States. | The used images are illustrative only. Subject to change without notice. | Printed in Bulgaria. All rights reserved. | Design and content by ACOM Ltd. | July 2020.